

LEYBOLD®

ELECTRICAL DRIVES

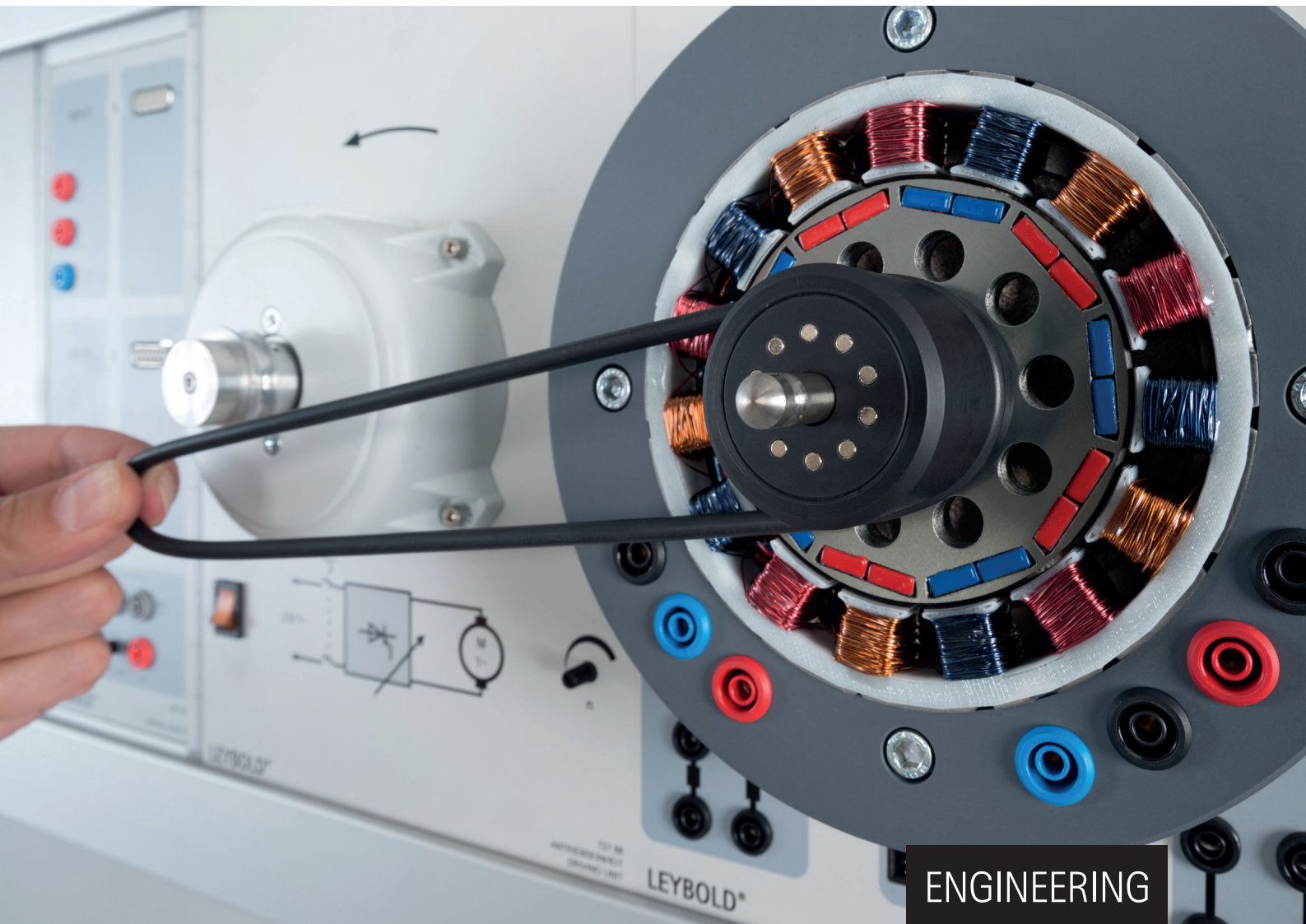

ENGINEERING

SYSTEMS FOR EDUCATION AND VOCATIONAL TRAINING

- Electrical machines
- Power electronics
- Drive and servo technology

ELECTRICAL DRIVES

TRAINING SYSTEMS FOR
VOCATIONAL AND ADVANCED TRAINING

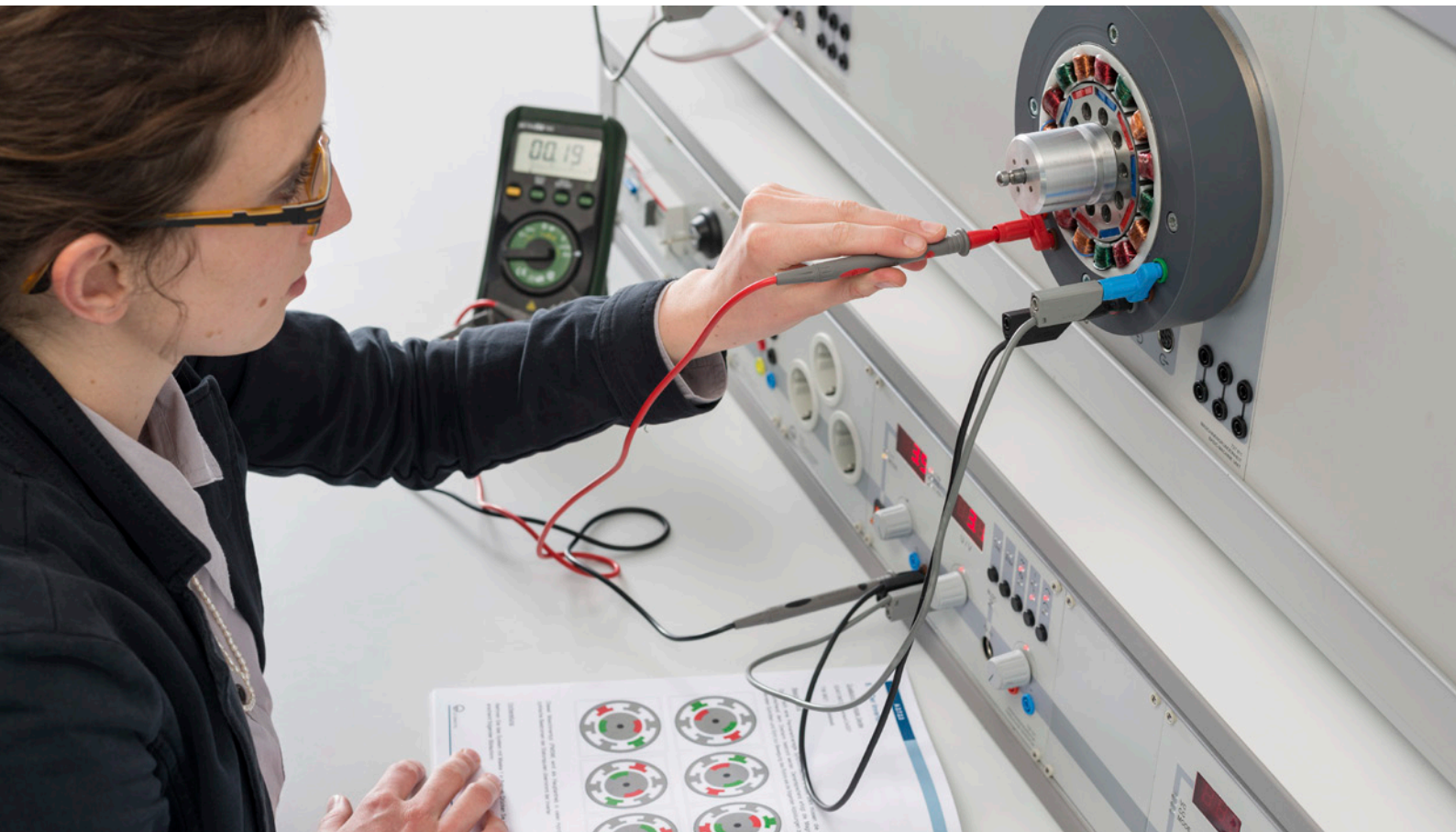

Use LEYBOLD training systems to impart to your students and trainees a multitude of training subjects in the areas of automotive, electrical engineering as well renewable energy technology. Our educationally-designed equipment and systems for technical vocational training combine theory and practical applications in an ideal manner and can be integrated perfectly into project work.

In this catalogue we will be presenting our training systems from the drive technology area. You are at the right address when it comes to obtaining customised solutions for your technology and workshop laboratory, designed especially for specific fields of training.

CONTENTS

LEYBOLD AT A GLANCE

NEWS	04
DOCUMENT CENTER	06
COM3LAB MULTIMEDIA	08
MACHINE TESTING SYSTEMS	10
STE PLUG-IN SYSTEM	12
TPS – TRAINING PANEL SYSTEM	14
LEYLAB – THE INTERACTIVE LAB	16
LAB AND FACILITY INSTALLATION PLANNING	18
CASSY – COMPUTER ASSISTED MEASUREMENT AND EVALUATION	20

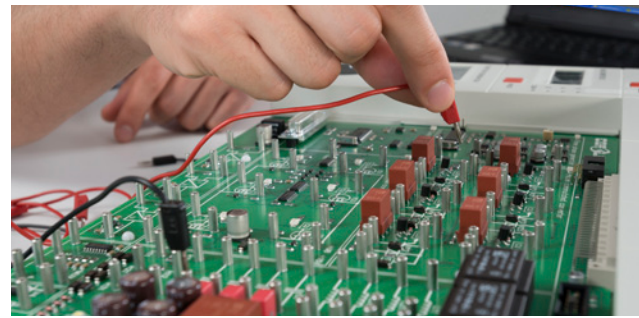
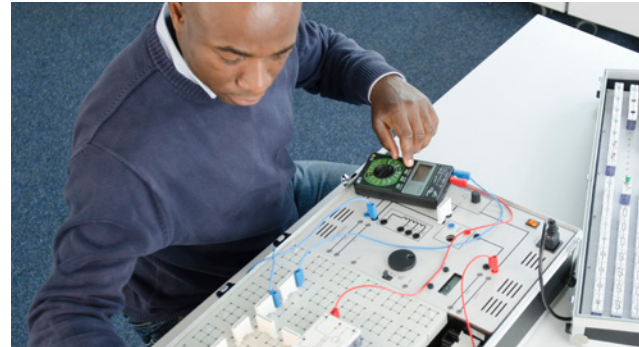

EQUIPMENT SETS ACCORDING TO TOPIC

COMPLETE EQUIPMENT SETS TAILORED
TO THE TRAINING CONTENT CAN BE FOUND

FROM PAGE 24 ONWARDS

INDIVIDUAL COMPONENTS

TECHNICAL DETAILS ON INDIVIDUAL COMPONENTS
IN EQUIPMENT SETS CAN BE FOUND

FROM PAGE 74 ONWARDS

INDEX

FROM PAGE 150 ONWARDS

NEW PRODUCT HIGHLIGHTS

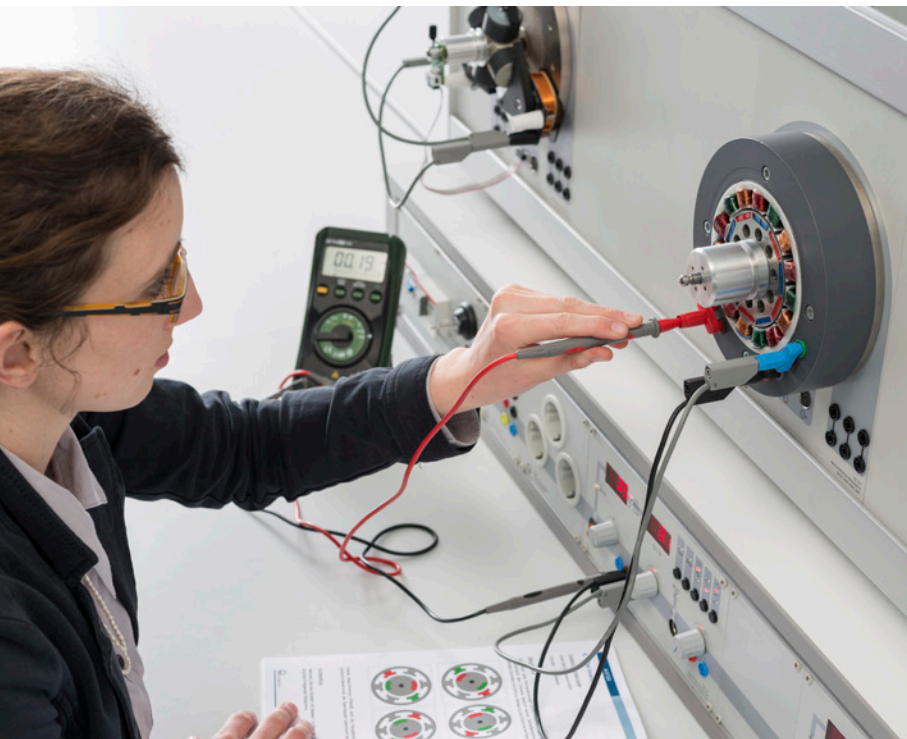

ENERGY-EFFICIENT ELECTRICAL MACHINES

Now this topic can also be investigated using the new LEYBOLD components for electrical machine teaching models.

By mounting a multipole stator and a rotor equipped with permanent magnets on our tried and true platform, it is now possible to cover completely new uses and applications during instruction.

Now for the first time, the topics of highly-efficient motor and generator operation can be investigated using this stator/rotor combination.



PERMANENT MAGNET ROTOR

SUPPLEMENT TO THE
ELECTRICAL MACHINE
TEACHING MODEL

FEATURES ELECTRICAL MACHINES

- Vertical electrical machine setup
- Three-phase stator with colour-coded windings
- Coloured rotor magnets
- Synchronous machine (PMSM)
- BLDC drive system or
- Modern type generator

727 815 ELM multipole stator rotor kit

727 816 ELM PM rotor magnets (internal)

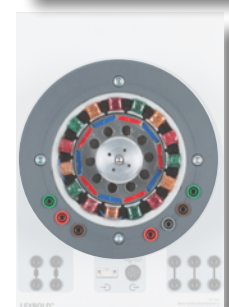
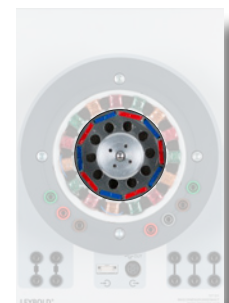

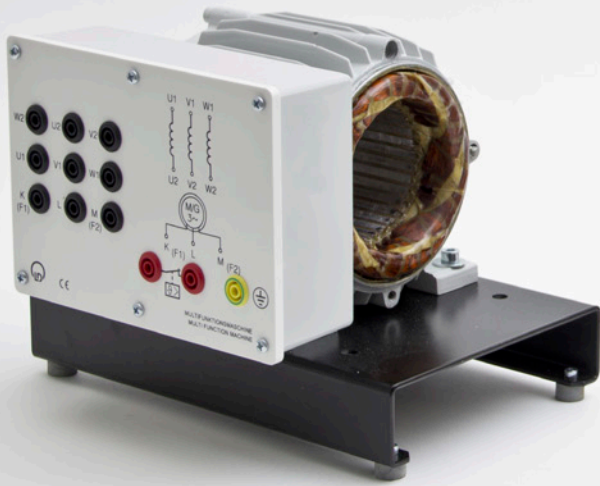

Stator with two rotors
for the machine model

NEW

MACHINES WITH INTERCHANGEABLE ROTORS

Machine models for mains voltage consist of a stator and various, interchangeable rotors. Once the stator and rotor have been assembled, a fully operational electrical machine of the 300 W class is realised.

The stator housing is mounted on a base and can be connected directly to the machine testing system 0.3 (731 989 USB). The star-shaped tie-bolts are responsible not only for the secure connection of the stator and the rotor but also the quick exchange of rotors. The rotors are equipped with B-type end shields, fan impellers, jackets and possibly slip-rings, brushes etc. In conjunction with the machine testing system, the machine characteristics can be traced back to particular features of the specific rotor. Depending on the rotor in use the machine model demonstrates the typical properties of induction (asynchronous) or synchronous machines.

747 720	Three-phase stator
747 721	Squirrel cage rotor

Additional rotors can be found in the catalogue section devoted to single components.

MACHINES
WITH
INTERCHANGEABLE
ROTORS



DOCUMENT CENTER

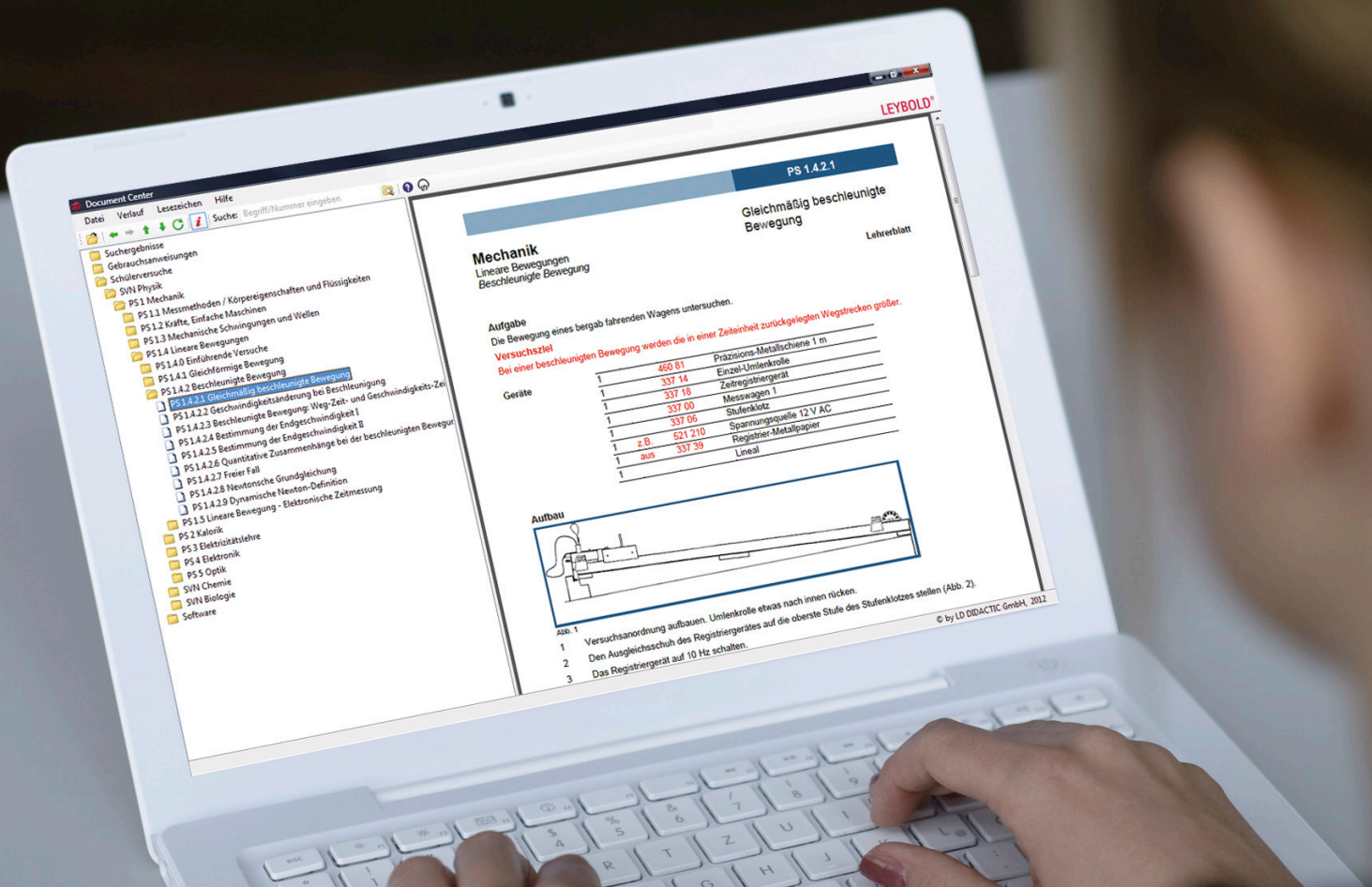

Download the
Document Center
free at:
www.ld-didactic.com

LEYBOLD'S ELECTRONIC LIBRARY

- Display and manage student experiment literature, demonstration experiment instructions or operating instructions in one program
- Automatically update all documents thanks to free online updates
- Benefit from convenient, fault-tolerant keyword and catalogue number search features

THE DAYS OF ENDLESS SEARCHING ARE OVER

The time consuming search for experiment instructions in folders is finally over. The new and free-of-charge Document Center saves you valuable class preparation time. With the new Document Center you have digital access to all the technical documentation which we have placed at your disposal (partially free-of-charge) in the form of extensive literature packets.

Once installed, you can set the documents to automatically update to the latest versions. The literature packets are clearly displayed in the form of a table of contents that also guides you intuitively to the desired document. The more literature packets you have installed, the more entries you will have in your table of contents.

Using the fault-tolerant search function you can quickly and easily find the correct document. Here again, the more literature packets installed, the more powerful the search function becomes.

CONDUCT EXPERIMENTS INTERACTIVELY AND LOG THE RESULTS DIGITALLY

Literature packets not only contain documents but also application data. Thus, for example, it is possible to take settings and examples from one of the experiment descriptions included in the literature packet and load this data into CASSY Lab with a simple click of the mouse.

If student and teacher versions from a packet are installed, switching back and forth between versions is also as easy as a mouse click. Student documents can be filled out in the Document Center and logged findings saved or printed out as a hardcopy.

Teacher version

Student version

COM3LAB MULTIMEDIA

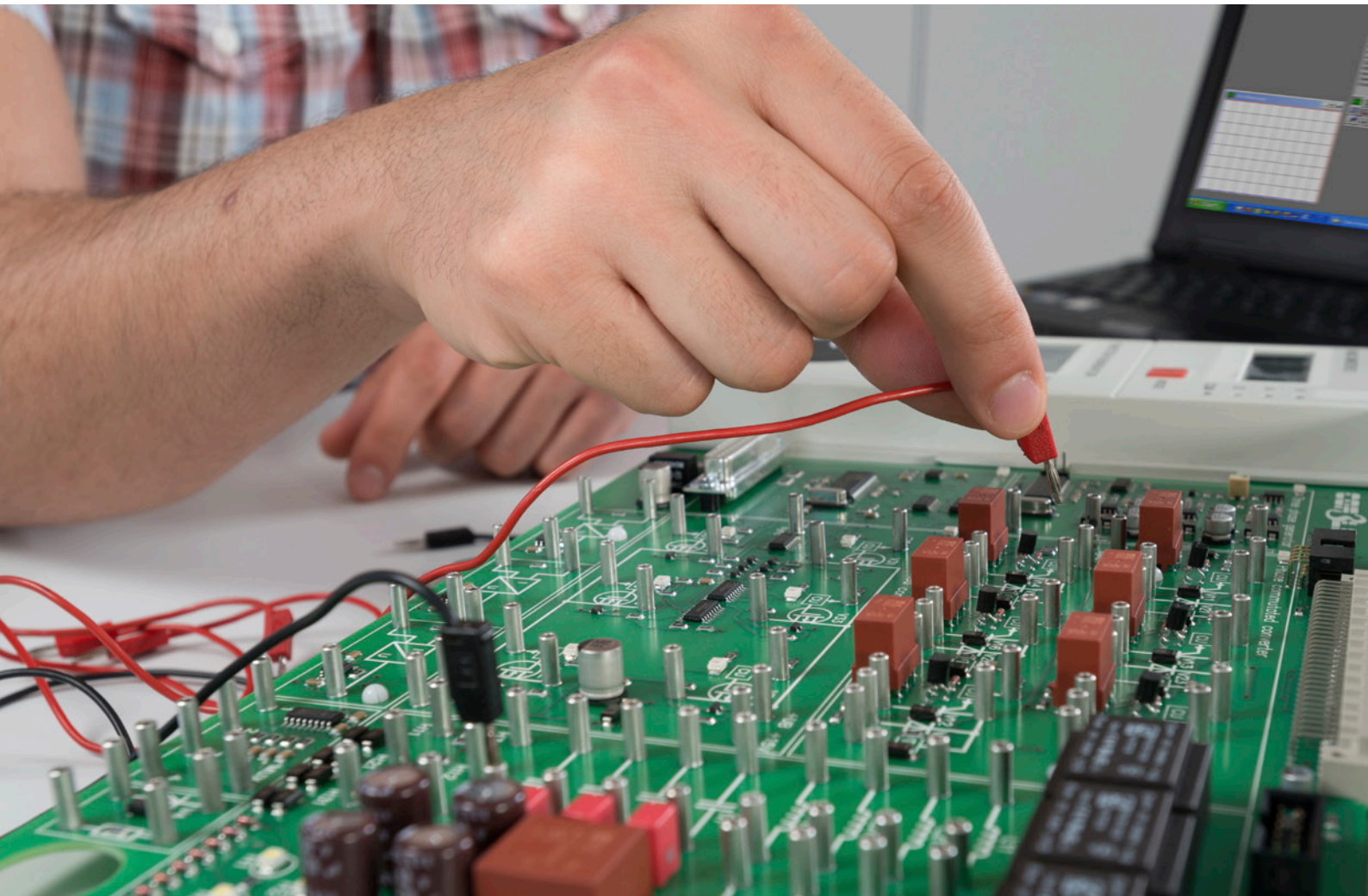

The master unit is compatible with all of the courses and includes two digital multimetres, a function generator, a digital storage oscilloscope and a digital analyser. By simply inserting a different experiment board into the Master Unit a completely new topic area can be explored.

New courses in the area of power electronics and electrical machines impart the subject's fundamentals and support the practical hands-on experimentation with measurable learning results.

THE OPTIMUM COMBINATION OF THEORY AND PRACTICE

COM3LAB Multimedia combines training software with real hardware that can be used in schools, universities or vocational training centres in industry.

COM3LAB courses are well suited for both classroom presentation, self-directed home study or for project work. They are comprised of an electronic and an interactive instruction manual and the corresponding hardware.

ADVANTAGES AT A GLANCE

FOR INSTRUCTORS

- In-depth content
- Practically-oriented experimenting
- Visually-appealing instruction material for presentation purposes
- Documentation with solutions for flexible application in the classroom
- Time-efficient assembly

FOR STUDENTS

- Practical hands-on learning
- Results are monitored and tested
- Results are documented
- Team-based or self-study possible
- Select the language of your choice

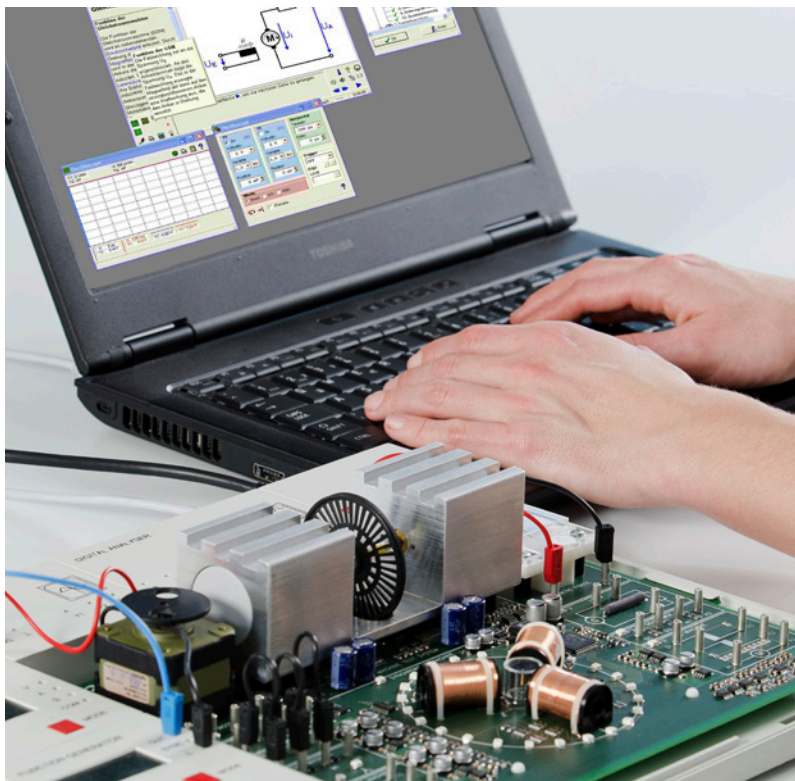

Drive technology is an important aspect of any technical education. With the COM3LAB courses the following, essential training fields are covered:

- Electronics for machines and drive technology
- Electronics for automation engineering

In this COM3LAB course, the basics of drive technology are presented and conveyed in an understandable way. The highlight of the course is the integrated machine testing system. This system allows you to really measure and compare the characteristics of all standard electrical motors.

There is an electronic, interactive text book included with each COM3LAB course each containing in-depth experiment instructions featuring technical specifications, images, videos and animations to support both theoretical and practical applications. Besides all of this material, the text book also contains a virtual laboratory and a large number of tools, e.g. for creating documentation.

COM3LAB COURSE: ELECTRICAL MACHINES

RECORDING CHARACTERISTICS AND CONNECTION TECHNIQUES OF ELECTRICAL MOTORS AND GENERATORS

- The most compact solution on the market for the topic of electrical machines
- Intelligent microcontroller permits a multitude of experiments and even includes an integrated machine testing system
- COM3LAB Multimedia combines training software with real hardware and can be used in schools, universities or vocational training centres in industry.

NEW

COM3LAB COURSE ELECTRICAL MACHINES I

MACHINE TESTING SYSTEMS

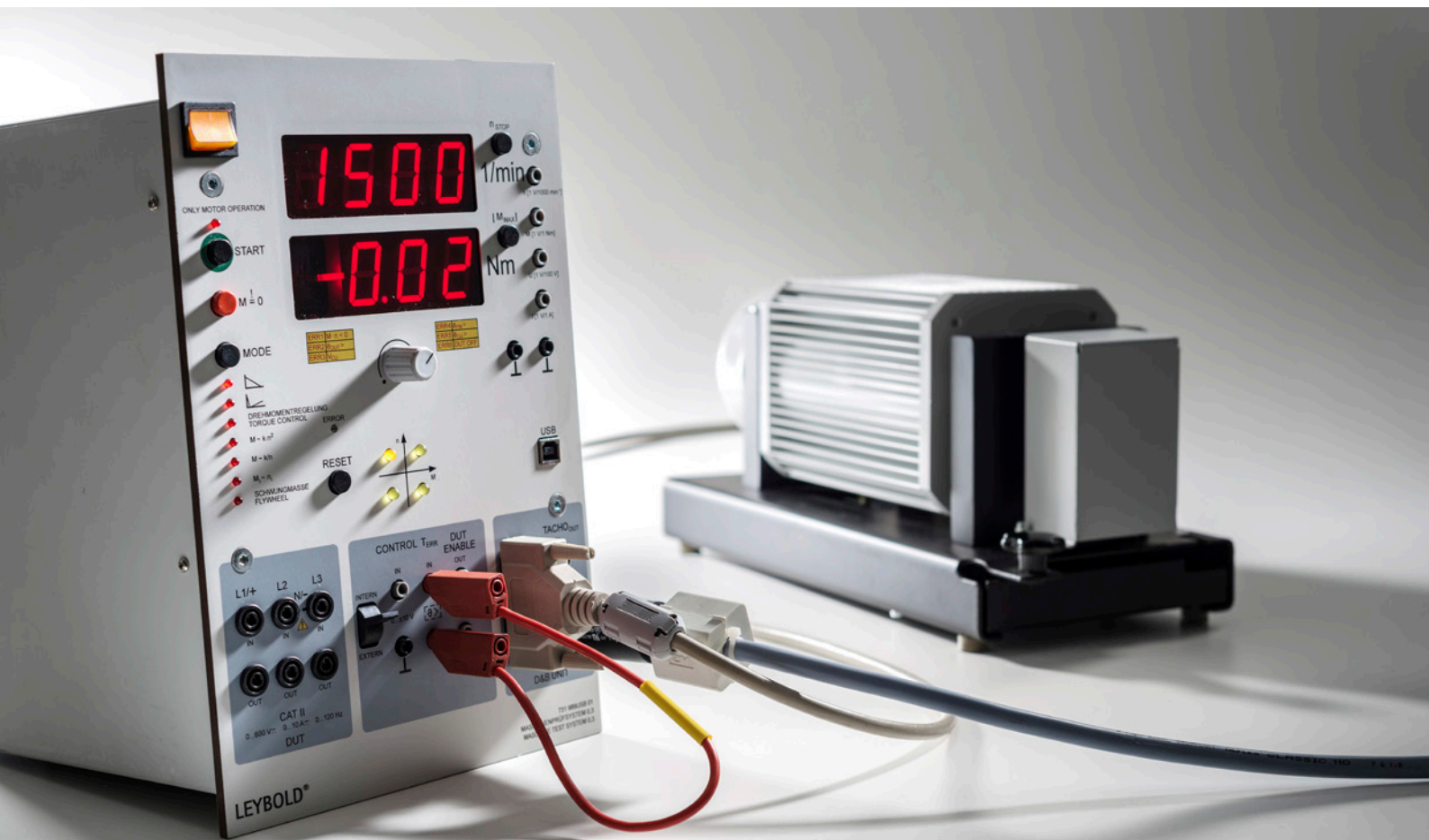

TOPICS

RECORDING THE CHARACTERISTICS OF ELECTRICAL MACHINES

- DC, AC and three-phase machines
- Investigating machines operating in motor and generator modes
- Plotting the locus diagrams for (asynchronous) induction motors (Heyland or circle diagrams)

ACTIVE LOAD SIMULATION

- Fan characteristic, winder characteristic
- Flywheel
- User-defined load characteristics

FEATURES OF THE MACHINE TEST SYSTEM

- Simple operation also without a PC
- Modular system configuration with short set-up time
- Test machines in 300 W or 1 kW power classes
- Protection for man and machine thanks to integrated temperature sensor and shaft-end monitoring of all machines
- Compare several characteristics on a single diagram
- Calculate mechanical and electrical characteristics
- Manage characteristic curves in table form
- Recording curves in both standardised and absolute plotted diagrams
- Blocking student access to select curves

SAFETY

- Monitoring shaft-end guard
- Temperature monitoring of the DUT

LEYBOLD MACHINE TEST SYSTEM PERFORMS IMPORTANT TASKS IN THE EXPERIMENT SET-UP:

- Regulated control of a motor braking system
- Measurement and processing of real-time data for computer-assisted characteristic evaluation
- Controlled drive of generators and drive gears

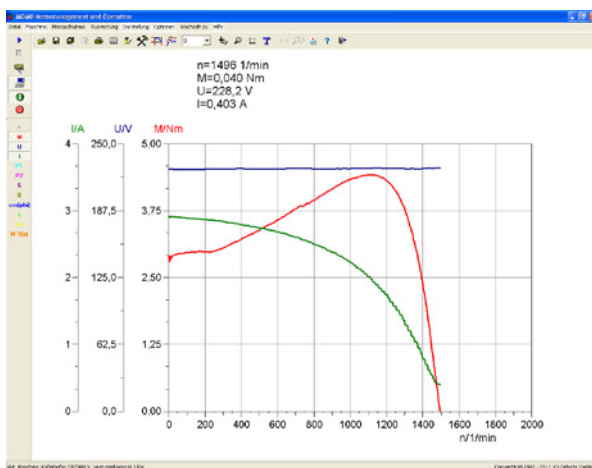

Torque-speed characteristic

This makes the recording of important characteristics of real motors and generators easy to do even for trainees and students.

In vocational training, the mechanical and electrical variables of electrical machines need to be measured and evaluated. To do this, the AC, DC or three-phase machine is securely and mechanically coupled to the drive and load unit of the machine test system. During the measurement the drive unit of the machine testing system continuously records the torque and speed of the machine under test.

Recording and evaluating characteristics is carried out by computer control using the CBM 10 software. Based on the torque, speed, current and voltage parameters measured directly, additional variables can be deduced, e.g. the power output and consumption, degree of efficiency, power factor $\cos \phi$.

STE PLUG-IN SYSTEM



The LEYBOLD plug-in system is a tried and tested experimentation program for electrical engineering and electronics. The extensive experimentation program covers beside the basics also advanced topics, for example, communications, IT, open- and closed-loop control technology as well as areas from automotive electronics.

Instruction sheets for students and accompanying teacher information are available to assist with the performance of experiments. The printed symbols on the plug-in housing elements, connectors and training panels provide the experiment set-ups with a circuit-like appearance. This facilitates the knowledge transfer between the circuit diagrams in the text books and the circuitry being assembled and makes the documenting of the experiment set-ups easier to do and ultimately promotes circuit-based thinking, learning and experimenting.

The STE case is the storage solution which also serves as a student workstation. The cover can be used to accommodate various STE equipment sets and also assist in performing experiments in the classroom. The clearly configured storage design permits quick setup and a quick start to experimenting.

ADVANTAGES

- Modular system
- Comfortable storage solutions for rapid assembly and disassembly
- Easy to expand
- Variety of A4 base panels, A3 available for vertical assemblies
- Clearly printed circuit symbols and designations

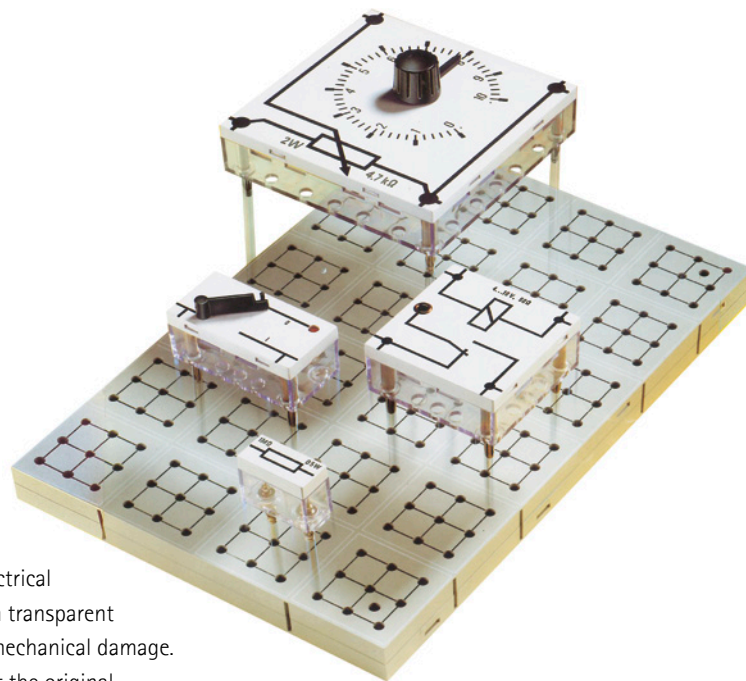

The STE elements come ready for operation and assembly with their electrical and electronic components encased in transparent housings to protect against external mechanical damage. Thanks to the transparent bottom part the original component is visible.

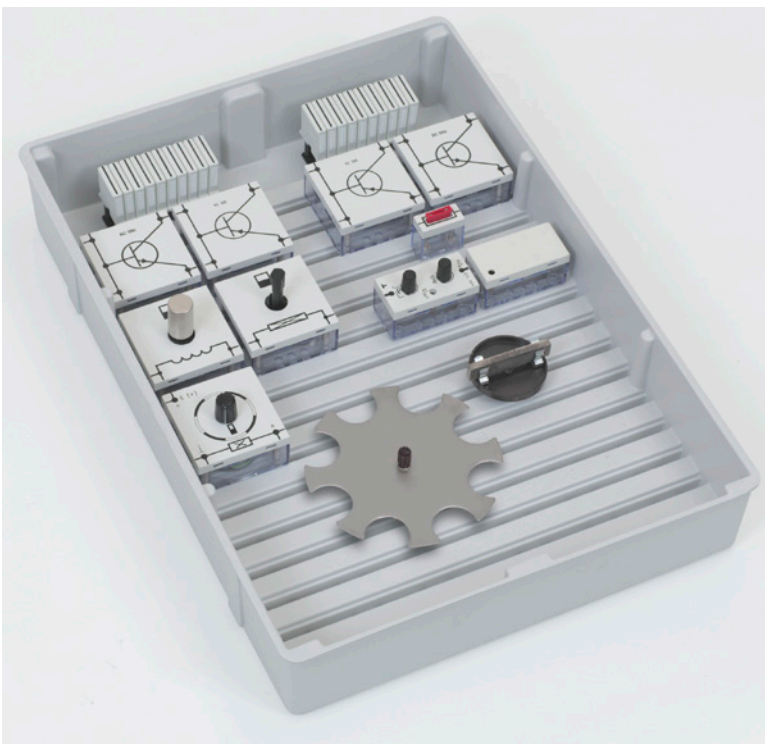

Stackable plastic trays offer alternatively a space saving and clear storage configuration of STE-elements, components and accessories in cabinets or drawers.

TPS - TRAINING PANEL SYSTEM

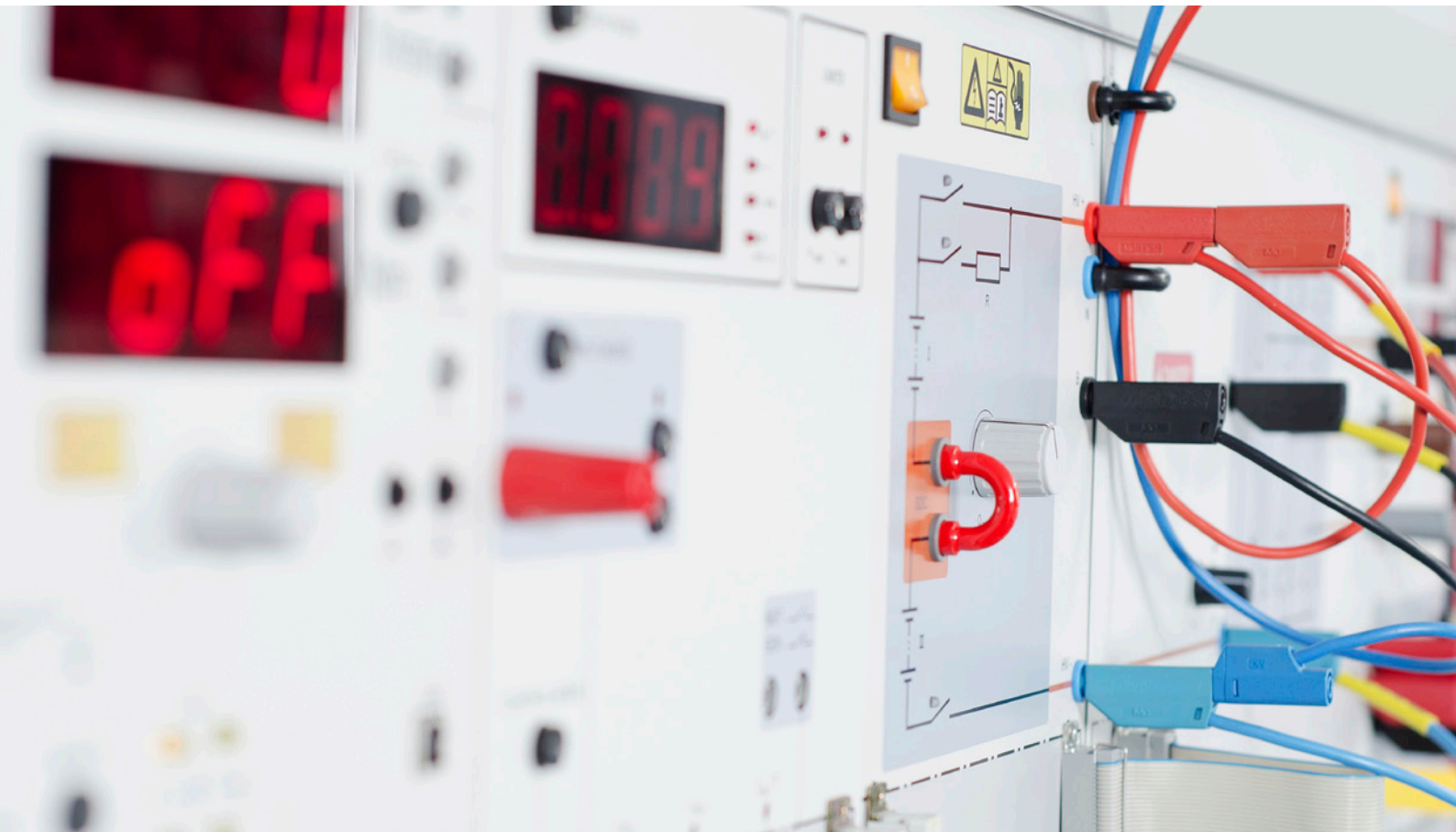

The LEYBOLD training panels are the centerpiece of the successful training systems. The equipment set configurations feature an outstanding modular design. All of the required training fields can be covered in their respective training topic areas using the TPS training panel equipment sets.

THE MODULAR TRAINING PANEL SYSTEM FOR STUDENT EXPERIMENTS AND CLASSROOM DEMONSTRATIONS

- Use of original components
- Experiment literature for classroom preparation and experiment procedures
- Featuring clearly laid out frontal panels

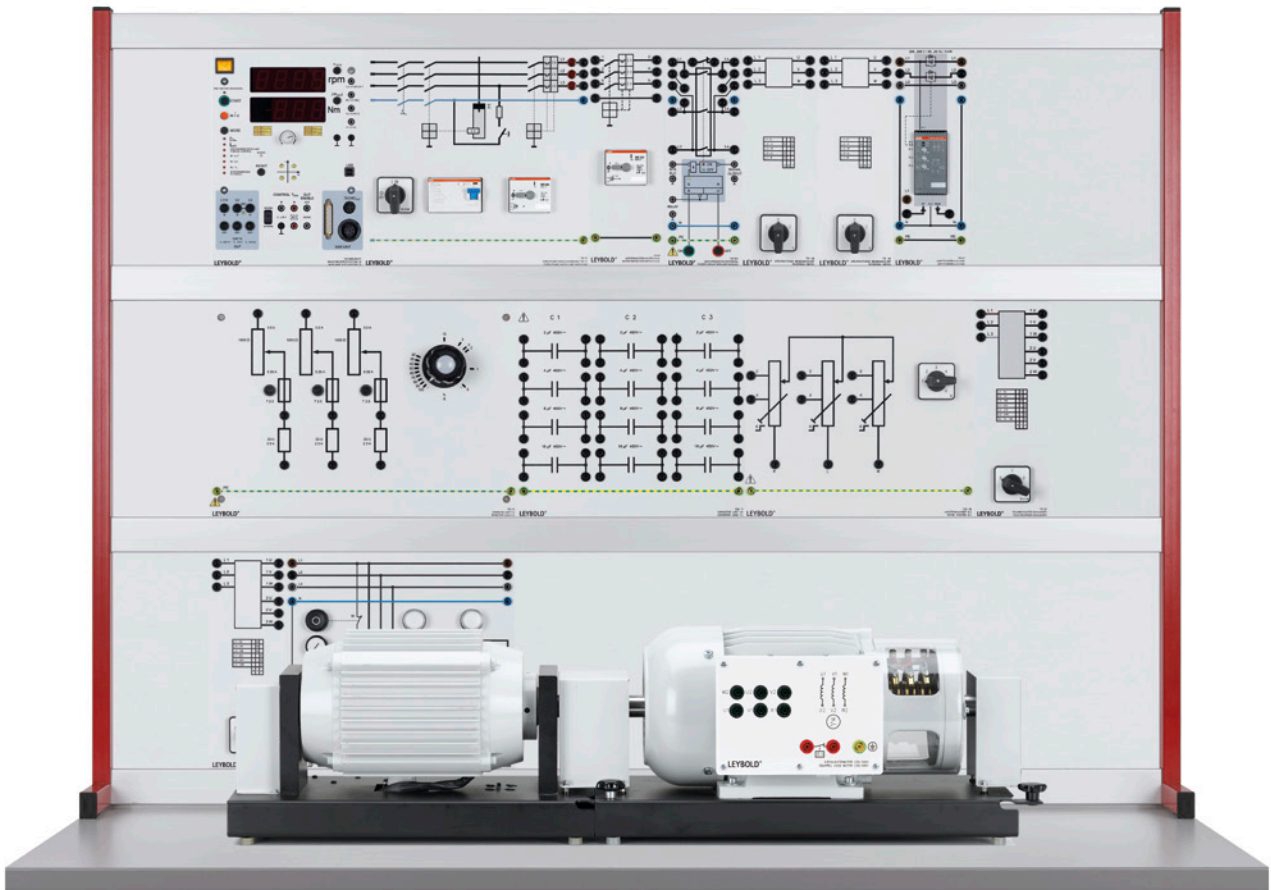

The systematic use of 4-mm safety sockets, cables and bridging plugs (jumpers), ensure that the experiment procedures are carried out safely. With the support of extensive experiment instructions and literature the students and trainees have lots of opportunities to acquire knowledge and new skills while at the same time deepening what they have already learned previously.

The proven TPS training panel system is also perfectly suited for instructors who have to demonstrate complex experiments. The additional TPS.NET and CASSY technologies offer the option of conducting all experiments with computer assistance. This builds a bridge between traditional learning and new technologies.



Thanks to the modular design, technology labs can quickly and easily be outfitted or extended using the TPS system.

LEYLAB

SAFETY FOR STUDENTS
AND EQUIPMENT ALIKE

LEYLAB.POWER

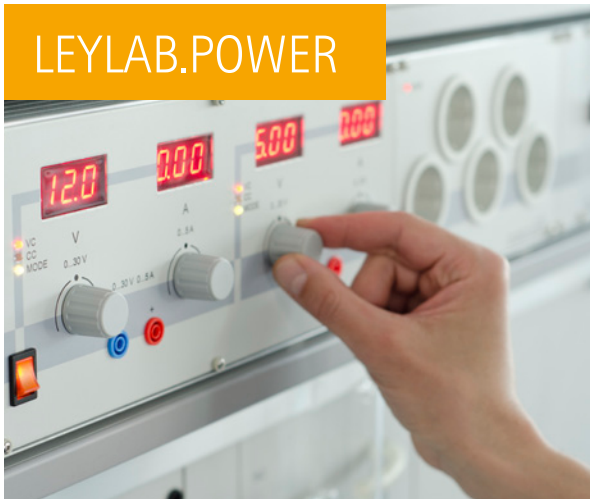

CONTROL AND REGULATE POWER
SUPPLIES USING LAN AND WLAN

From the teacher's PC, the instructor has password protected access to all of the equipment and can take readings and change settings at any time. Furthermore, for the protection of the connected training environment, maximum parameter limits can be set which the students cannot manipulate.

CENTRAL CONTROL
AND REGULATION
FROM TEACHER'S PC

FAULT SIMULATION
INITIATED FROM
TEACHER'S PC

LEYLAB.CONTROL

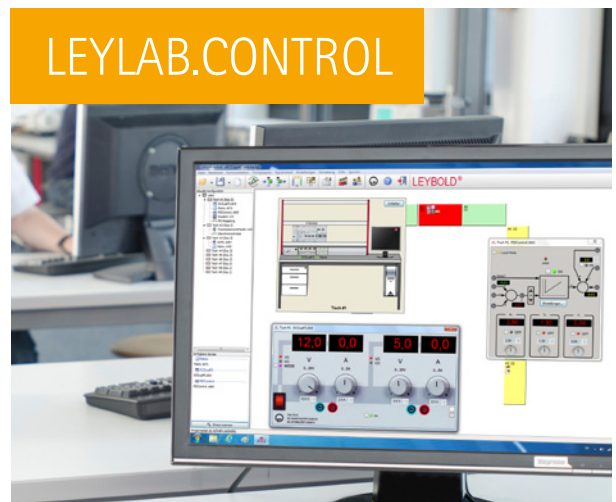

THE CUSTOMISED, INTERACTIVE TECHNOLOGY LAB OF THE FUTURE

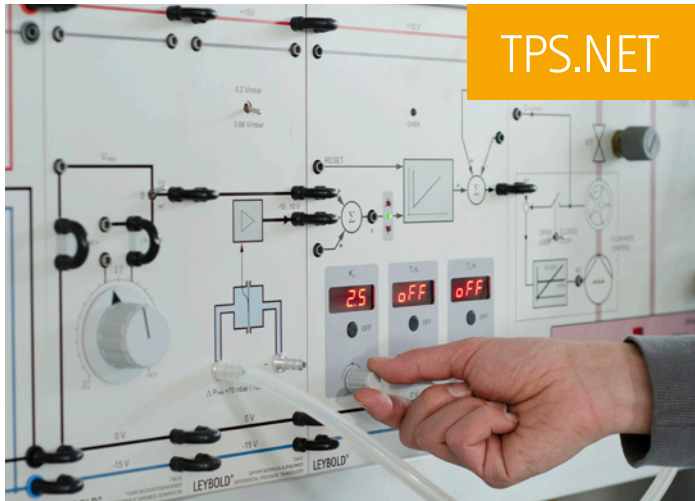

MONITOR
AND CHECK ON
STUDENTS

NETWORK-CAPABLE EXPERIMENTING MODULES

Network-capable TPS modules are equipped with an Ethernet port so that they can be integrated into the LEYLAB.control concept. While the students are busy conducting experiments, the teacher can either monitor or actively access their equipment from his or her computer. Measurement data acquisition, the setting of parameters and limiting values and safe fault simulation are thus possible.

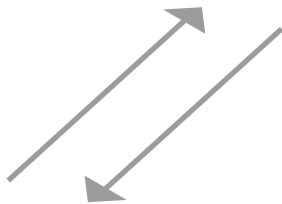

REMOTE CONTROL OF ALL LABORATORY EQUIPMENT

The LEYLAB.control software is the control centre at the heart of the networked laboratory and permits the switching and activation of interconnected power supply units of the LEYLAB.power series as well as the networkable training panels of the TPS series. The instructor can map out his or her laboratory on the program interface and thus obtain a graphic overview of all the equipment connected via Ethernet.

DIRECT
COMMUNICATION
WITH STUDENT PC
AND THE EXPERIMENT
MODULES

FACILITY & LAB PLANNING AND INSTALLATION



YOUR NEW LEYBOLD LAB FACILITY

Based on your ideas, we team up with you and plan a lab or classroom facility that fits your syllabus. Our room planners custom design your laboratory simply by tailoring the desired experiment equipment, furniture and storage solutions to your specific needs.

Thanks to our many years of experience, we are reliable partners in all phases of project planning from conception to implementation.

EVERYTHING YOU NEED FROM A SINGLE SOURCE

LAB AND CLASSROOM PLANNING

- Furnishings designed for practical use
- In compliance with safety standards
- Blueprints and planning documents
- Specification of performance features

FURNITURE

- Customised solutions
- Networked training systems
- Storage systems designed to fit equipment and equipment sets
- Long availability & supplementation guarantee

FINANCING

Leasing offers for technical equipment and furnishings



LEYBOLD®

CASSY – COMPUTER-ASSISTED MEASUREMENT AND EVALUATION

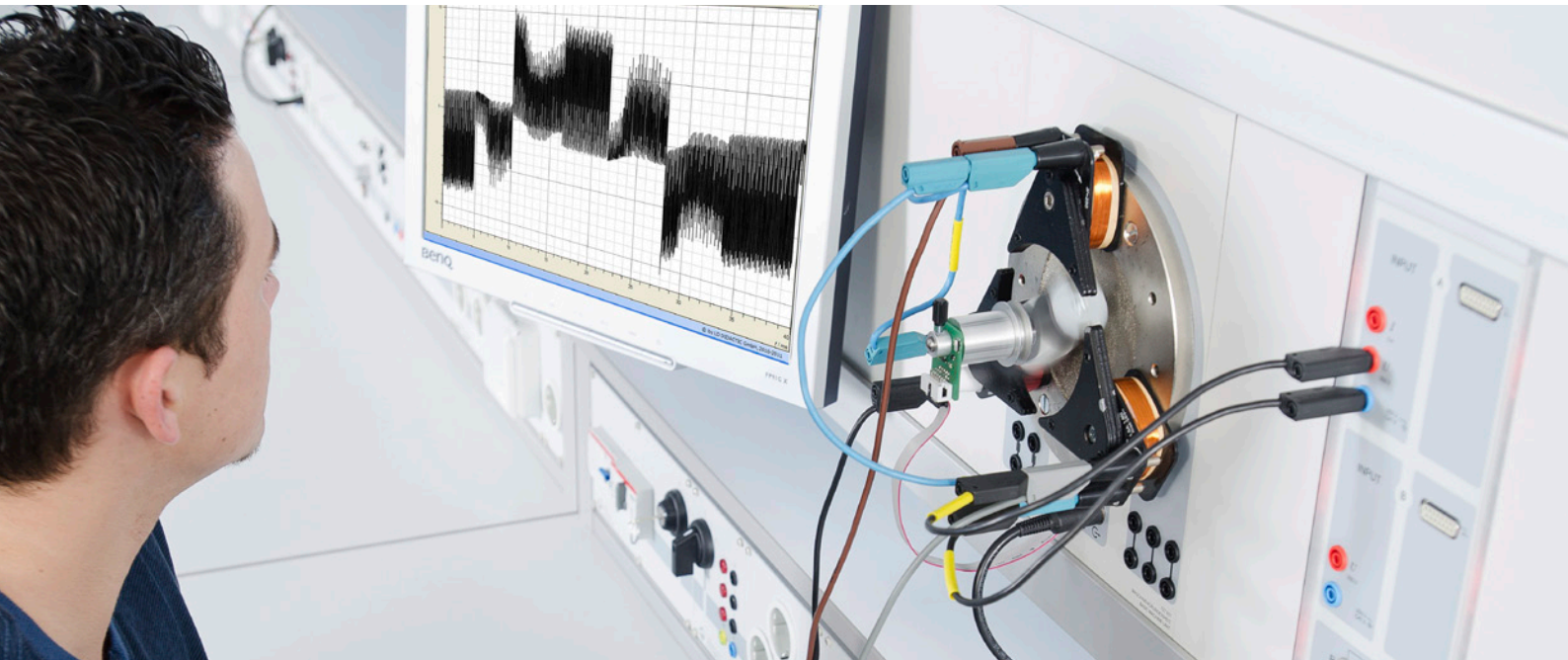

The modular CASSY system makes computer-assisted measurement and evaluation possible for all training and educational levels up to university level.

THE CASSY SYSTEM COVERS:

1. Interface for recording measurement data
2. Comprehensive offering of sensors for the detection of electrical and non-electrical variables
3. CASSY Lab 2: The intuitive and easy-to-use software for measurement and evaluation designed to fit all of the equipment and sensors

SENSORS (SELECTION)

Catalogue No.	Designation
738 987	Capacitive-type pick-up
738 986	Inductive-type pulse pick-up
524 064	Pressure sensor S
524 044	Temperature sensor S
524 0511	Lux adapter S
666 243	Lux sensor
524 031	Current source box
524 043	30 A box
524 0512	Optical performance sensor

SENSOR-CASSY 2

INTERFACE FOR RECORDING MEASUREMENT DATA

- For connection to the USB port of a computer, to an additional CASSY module or to the CASSY display
- Simultaneous measurement of voltage, current and two additional variables possible
- Automatic sensor box recognition
- Can be setup as table-top, console or demonstration unit (also in CPS/TPS experiment frames)

PLUG & PLAY

Automatic detection and setting of Sensor-CASSY and sensor boxes

COMPATIBLE

with all CASSY sensor boxes and sensors

Sensor-CASSY 2 (524 013) provides two electrically separated voltage inputs, an alternative current input and two sensor box inputs parallel to this. All inputs have variable measurement ranges. Technical specs can be found in the individual component section of the catalogue.



PROFI-CASSY

INTERFACE FOR ALL AREAS OF ELECTRICAL ENGINEERING

- For connection to the USB port of a computer
- Microcontroller-controlled with the CASSY-operating system (upgrades and expansions can be easily updated anytime via software)
- Variable set-up as table-top, console or demonstration device (also in CPS/TPS experiment frames)

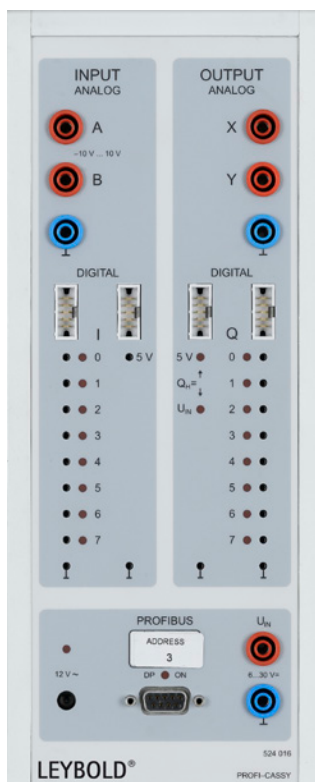

Technical data for the Profi-CASSY (524 016) can be found in the individual component section of the catalogue.

SAVE TIME AND EFFORT DURING CLASS PREPARATION AND EXPERIMENT PROCEDURES

LEYBOLD solutions are not only tailored for complex training subjects but also for the continuously growing demands being placed on teachers and instructors. You will only have to invest a short amount of time in preparing your classes or to set up your experiments. This is because with the extensive experiment literature accompanying our systems, you receive guidelines for demonstration experiments that can also serve as experiment instructions and exercise handouts for your students.

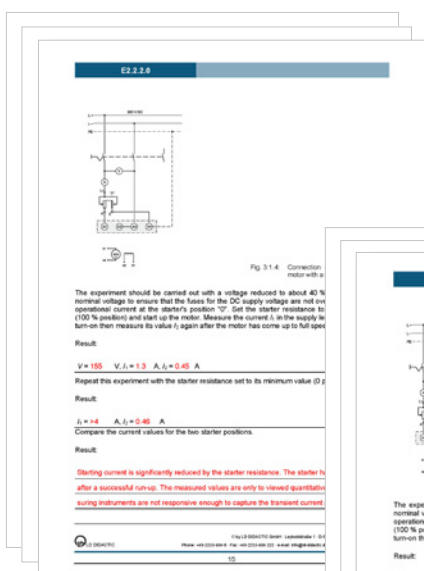

Teacher version

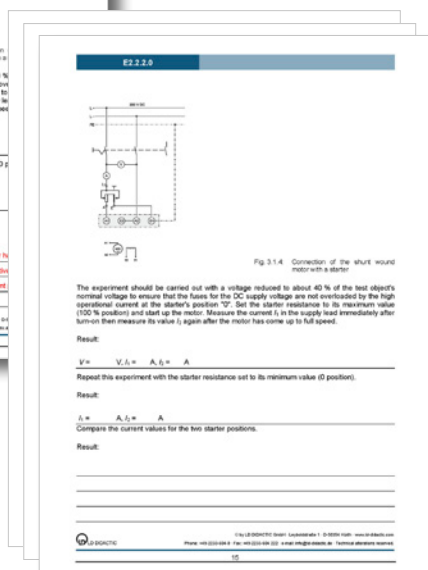

Student version

LITERATURE

THE EXPERIMENT LITERATURE HAS BEEN WRITTEN WITH SPECIAL EDUCATIONAL CONSIDERATIONS TO SIMPLIFY AND FACILITATE CLASSROOM AND EXPERIMENTATION PREPARATION FOR INSTRUCTORS.



GENERAL INFORMATION

Customer desk	+ (49) 22 33 / 604 – 430
	Order processing
	Available Mon.–Thur. from 8.00 am– 4.00 pm and Fr. from 8.00 am – 2.45 pm
Order fax	+ (49) 22 33 / 604 – 193
Help-Line	+ (49) 22 33 / 604 – 301
	Technical support for queries, advice on equipment or experiments
	Available Tues. from 10.00 am – 12.00 pm and Thur. from 2.00 pm – 4.00 pm
E-mail	info@ld-didactic.de
Internet	www.ld-didactic.de

INFORMATION CONCERNING TENDERS

Your contact partners Mr. Kattwinkel and Mr. Schilling are at your disposal from Mon.–Thur. from 8.00 am to 4.00 pm and Fr. 8.00 am to 2.45 pm.

Contact data:

Achim Kattwinkel

Telefon + (49) 22 33 / 604 – 272

E-mail akattwinkel@ld-didactic.de

Hans Peter Schilling

Telefon + (49) 22 33 / 604 – 305

E-mail pschilling@ld-didactic.de

TECHNICAL SERVICE

Should you have any questions regarding a component or an equipment set: Our service team is at your disposal by phone at + (49) 22 33 604 – 430 and per E-mail under service@ld-didactic.de.

YOUR PERSONAL TECHNICAL ADVISOR

You can find the contact data of the technical advisor you need on our internet page.

EQUIPMENT SETS

ELECTRICAL DRIVES

On the following pages, we present a collection of stand-alone and fully-operational experiment set-ups. These contain individual units, instrumentation, software and teachware. The equipment sets are based on training fields currently required in standard training and education.

Of course, the modular solutions of these equipment sets can be adapted to your specific needs. We are happy to advise you, just ask us!

The following pages present our extensive offering of electrical drives. A brief definition of the term "drive" should help to explain the structure of this catalogue. A drive always comprises two machines coupled together. The motor or driving machine generates the required speed or torque and the working machine absorbs the mechanical energy required to perform the desired process. In the case of an electrical drive the motor is an electrical machine. In modern, electrical drives, the energy-efficient supply of electrical power is performed using power electronics components, e.g. power converters and frequency converters. When high demands are being made on the electrical drive's speed and torque stability, additional automatic control technology is then required. One special area of control applications for closed-loop electrical drives includes positioning or servo drives. For that reason, the catalogue has been arranged in the following topic areas:

E2 ELECTRICAL DRIVES

E2.1	EDUCATIONALLY DESIGNED MACHINES	25-31
E2.2	INDUSTRIAL MACHINES 300 W	32-40
E2.3	INDUSTRIAL MACHINES 1 KW	41-47
E2.4	POWER ELECTRONICS	48-55
E2.5	DRIVE TECHNOLOGY	56-65
E2.6	SERVO TECHNOLOGY	66-73

Detailed information on our equipment sets can also be found at our webpage.

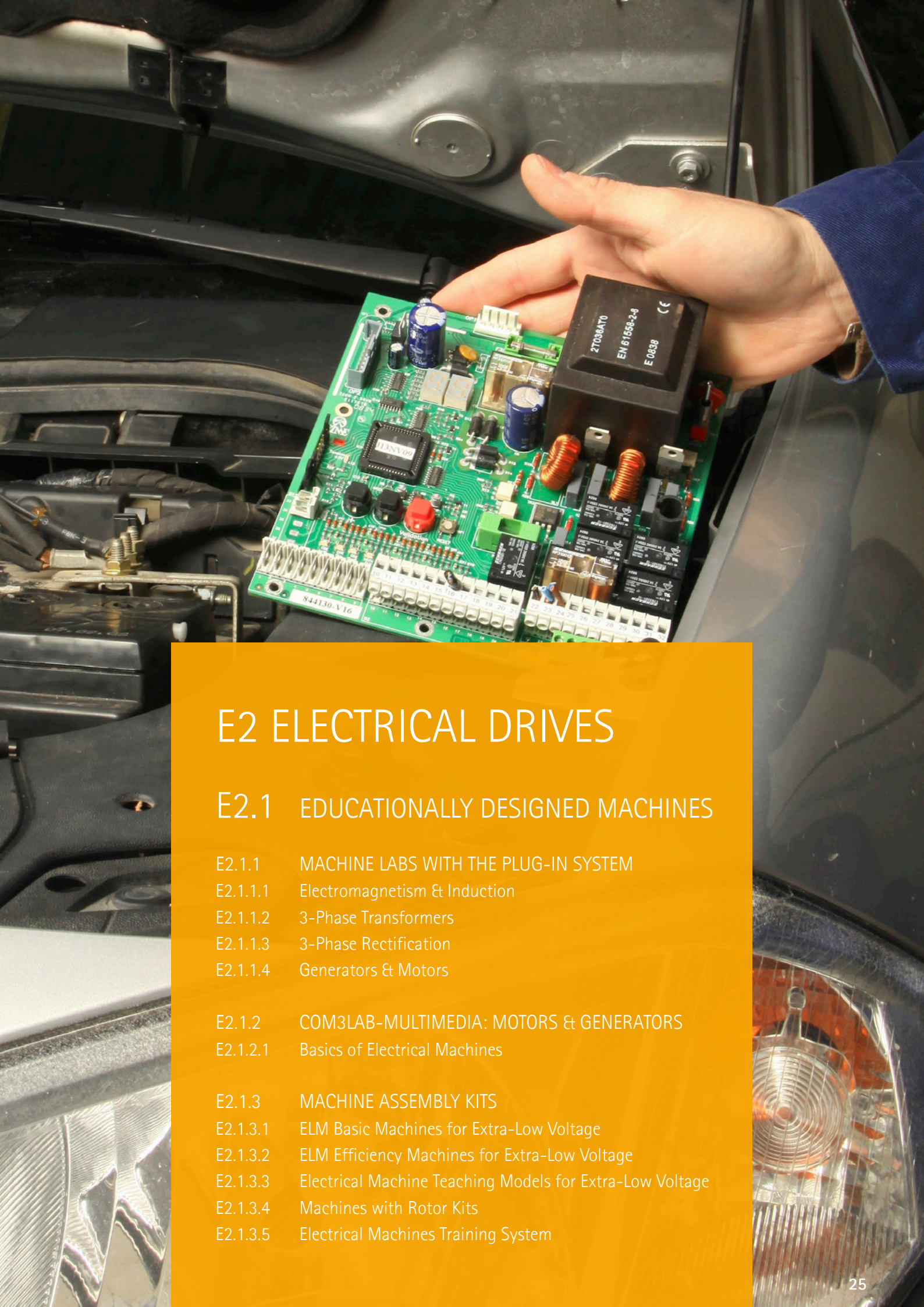

E2 ELECTRICAL DRIVES

E2.1 EDUCATIONALLY DESIGNED MACHINES

E2.1.1 MACHINE LABS WITH THE PLUG-IN SYSTEM

- E2.1.1.1 Electromagnetism & Induction
- E2.1.1.2 3-Phase Transformers
- E2.1.1.3 3-Phase Rectification
- E2.1.1.4 Generators & Motors

E2.1.2 COM3LAB-MULTIMEDIA: MOTORS & GENERATORS

- E2.1.2.1 Basics of Electrical Machines

E2.1.3 MACHINE ASSEMBLY KITS

- E2.1.3.1 ELM Basic Machines for Extra-Low Voltage
- E2.1.3.2 ELM Efficiency Machines for Extra-Low Voltage
- E2.1.3.3 Electrical Machine Teaching Models for Extra-Low Voltage
- E2.1.3.4 Machines with Rotor Kits
- E2.1.3.5 Electrical Machines Training System

Machine Labs with the Plug-In System

E2.1.1.1
Electromagnetism & Induction

E2.1.1.2
3-Phase Transformers

E2.1.1.3
3-Phase Rectification

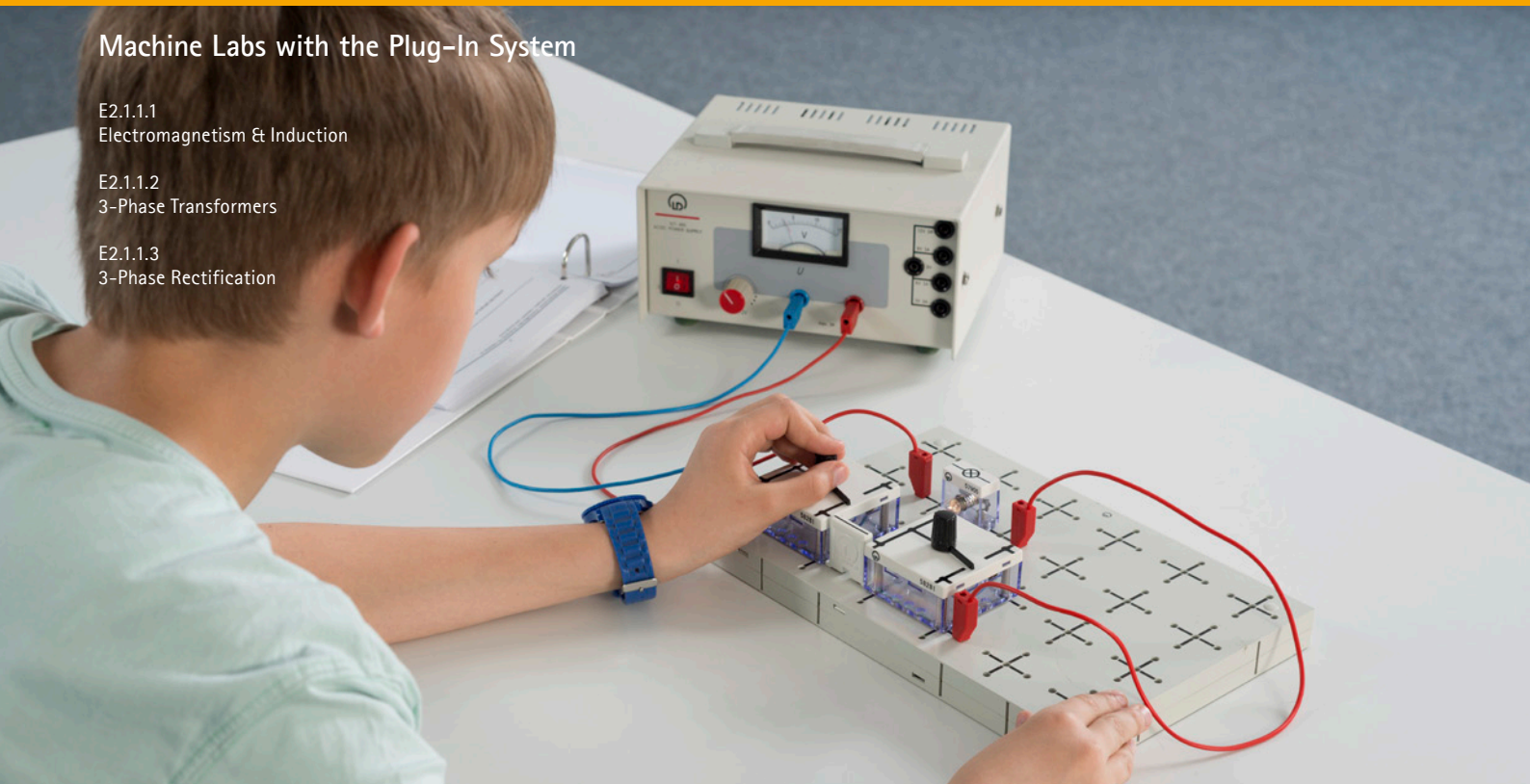

Electromagnetism & Induction (E2.1.1.1)

Cat. No.	Description	E2.1.1.1	E2.1.1.2	E2.1.1.3
588 871S	Advanced Science Kit - Set BEL	1		
588 875S	Advanced Science Kit - Set ELI 1	1		
588 876S	Advanced Science Kit - Set ELI 2	1		
521 485	AC/DC power supply, 0...12 V/3 A	1		
685 48ET5	Batteries 1.5 V (D, mono), set of 5	1		
531 120	Multimeter LDanalog 20	2		
459 32	Candles, set of 20	1		
505 07	Bulbs, 4 V/0.16 W, E10, set of 10	1		
505 08	Bulbs, 12 V/3 W, E10, set of 10	1		
505 11	Bulbs, 2.5 V/0.25 W, E10, set of 10	1		
550 42	Constantan resistance wire, 0.35 mm diameter, 100 m	1		
550 46	Chrome-nickel resistance wire, 0.25 mm diameter, 100 m	1		
550 47	Chrome-nickel resistance wire, 0.35 mm diameter, 100 m	1		
550 51	Iron resistance wire, 0.2 mm diameter, 100 m	1		
578 39	Capacitor (electrolytic), 100 µF, STE 2/19	1		
578 40	Capacitor (electrolytic), 470 µF, STE 2/19	1		
667 017	Scissors, 125 mm, round-ended	1		
501 44	Connecting leads, 19 A, 25 cm, red/blue, pair	3		
501 45	Connecting lead, 19 A, 50 cm, red/blue, pair	1		
501 441	Connecting lead, 19 A, 25 cm, black, pair	1		
588 35DE	LIT: PS3.5 STM Electricity - Electromagnetism	1		
588 34DE	LIT: PS3.4 STM Electricity - Basic electric circuits	1		
588 35EN	LIT: PS3.5 STM Electricity, Electro-magn	1*		
588 34EN	LIT: PS3.4 STM, Basic electric circuits	1*		
727 514	Basic set T 2.4.1, STE		1	1
576 74	Plug-in board, DIN A4, STE		1	2
578 795	Three-phase voltage supply, 3x12 V, STE 6/100		1	1
562 791	Plug-in power supply, 12 V AC		1	1
501 641	Two-way adapters, red, set of 6		3	3
524 013S	Sensor-CASSY 2 Starter		1	1
575 212	Two-channel oscilloscope 400		1*	1*
575 231	Probe 100 MHz, 1:1 / 10:1		2*	2*

Cat. No.	Description	E2.1.1.1	E2.1.1.2	E2.1.1.3
531 282	Multimeter Metrahit Pro		2*	2*
501 23	Connecting lead, 32 A, 25 cm, black		9	12
501 28	Connecting lead, 32 A, 50 cm, black		6	9
501 26	Connecting lead, 32 A, 50 cm, blue		2	2
501 30	Connecting lead, 32 A, 100 cm, red		2	4
501 33	Connecting lead, 32 A, 100 cm, black		2	4
501 48	Bridging plugs, STE 2/19, set of 10		2	3
565 641L	LIT: Three-phase transformers and three-phase transformer circuits, T 2.4.1 (German)	1		
565 641S	LIT: Three-phase transformers and three-phase transformer circuits T 2.4.1 (German)	1		
565 642	LIT: Three-phase transformers and three-phase transformer circuits T 2.4.1 (English)	1*		
727 515	Basic set T 2.4.2, STE			1
524 013	Sensor-CASSY 2			1
501 02	BNC cable, 1 m			2*
565 651L	LIT: Three-phase rectifier circuits, T 2.4.2 (German)			1
565 651S	LIT: Three-phase rectifier circuits, T 2.4.2 (German)			1
565 652	LIT: Three-phase rectifier circuits T 2.4.2 (English)			1*

* additionally recommended

The experiments are carried out using the STE plug-in system Electricity/Electronics.

Objectives

- Recognition of basic physical principles
- Implementation of electrical circuits according to circuit diagrams

The target group is made up of students in general or vocational education. The experiments are designed as an introduction at a simple level of understanding.

Topics (selection)

- Circuits, conductors and insulators
- Change-over / two-way circuits
- AND and OR circuits
- Measurement of current, voltage etc.
- Star / delta configuration
- Vector groups for three phase transformers
- Power for three-phase loads
- Diodes with R and RL loads
- Circuits: M2U, M3U, M6U, B2U, B6U

Machine Labs with the Plug-In System

E2.1.1.4
Generators & Motors

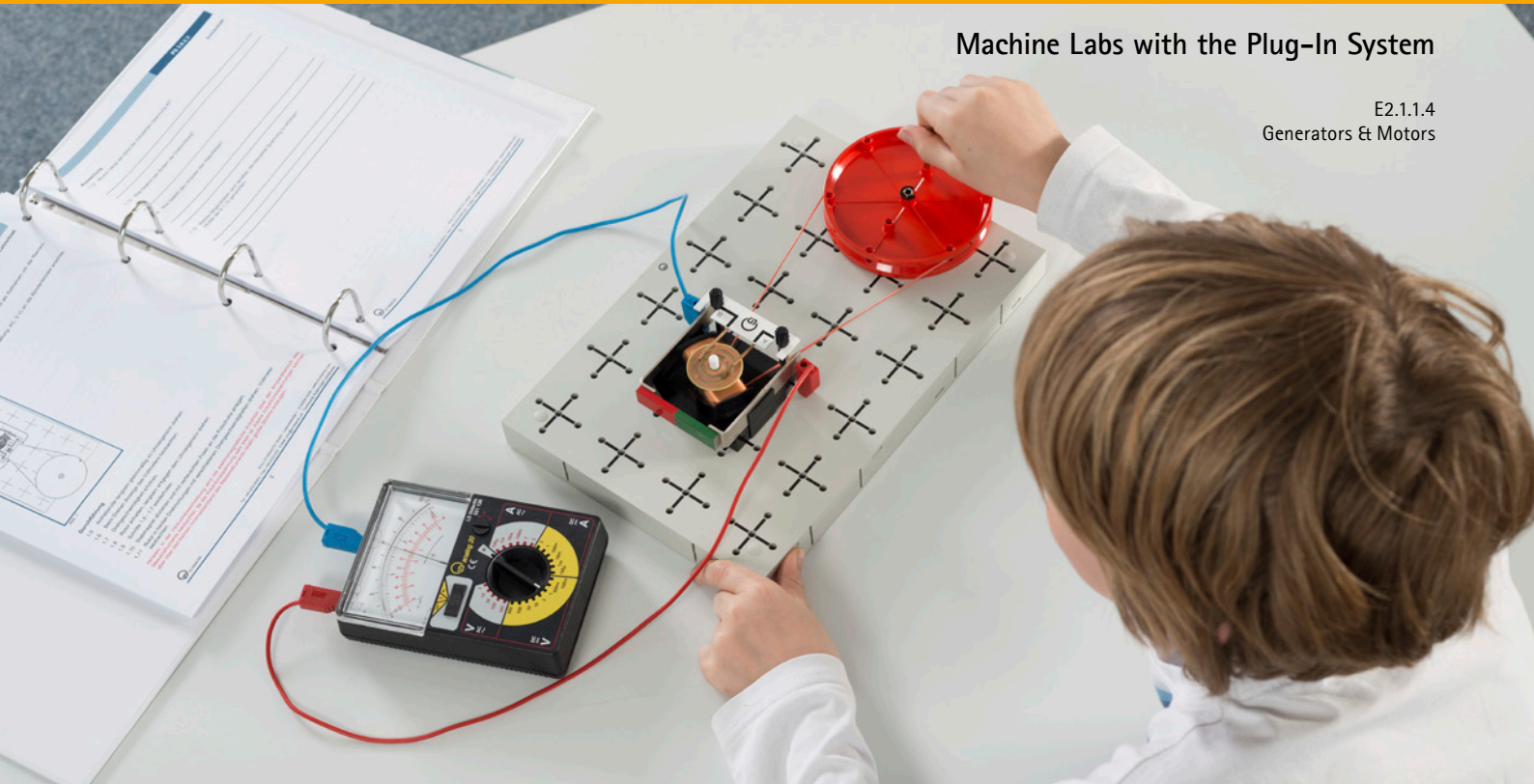

Generators & Motors (E2.1.1.4)

Cat. No.	Description	E2.1.1.4
588 871S	Advanced Science Kit - Set BEL	1
588 875S	Advanced Science Kit - Set ELI 1	1
588 876S	Advanced Science Kit - Set ELI 2	1
588 877S	Advanced Science Kit - Set ELI 3	1
521 485	AC/DC power supply, 0...12 V/3 A	1
522 621	Function generator S 12	1
685 48ET5	Batteries 1.5 V (D, mono), set of 5	1
531 120	Multimeter LDanalag 20	2
459 32	Candles, set of 20	1
505 07	Bulbs, 4 V/0.16 W, E10, set of 10	1
505 08	Bulbs, 12 V/3 W, E10, set of 10	1
505 11	Bulbs, 2.5 V/0.25 W, E10, set of 10	1
550 42	Constantan resistance wire, 0.35 mm diameter, 100 m	1
550 46	Chrome-nickel resistance wire, 0.25 mm diameter, 100 m	1
550 47	Chrome-nickel resistance wire, 0.35 mm diameter, 100 m	1
550 51	Iron resistance wire, 0.2 mm diameter, 100 m	1
578 39	Capacitor (electrolytic), 100 µF, STE 2/19	1
578 40	Capacitor (electrolytic), 470 µF, STE 2/19	1
667 017	Scissors, 125 mm, round-ended	1
340 900	Rubber rings, set of 50	1
340 811ET2	Plug-in axles, set of 2	1
340 921ET2	Pulley 100 mm Ø, plug-in, pair, set of 2	1
501 44	Connecting leads, 19 A, 25 cm, red/blue, pair	3
501 45	Connecting lead, 19 A, 50 cm, red/blue, pair	2
501 441	Connecting lead, 19 A, 25 cm, black, pair	1
588 36DE	LIT: PS3.6 Electricity, Motors (German)	1
588 36EN	LIT: PS3.6 Electricity, Motors	1*

* additionally recommended

Self-assembly of electrical machines is particularly effective for building understanding of how motors and generators work. For example, the process of commutation and the forces involved in it can be grasped intuitively and is especially clear when machines are rotating slowly.

The equipment set incorporates student experiments which can be carried out in a laboratory safely using safety extra-low voltage. Experiment instructions are contained in a manual in either printed or digital form.

For more advanced work, the following sets are recommended:

- E2.1.1.1 Electromagnetism & induction
- E2.1.1.2 Three-phase transformers
- E2.1.1.3 Three-phase rectification

Topics

- Magnetic field of a stator
- Magnetic fields of rotors
- How rotors respond in the magnetic field of a stator
- Electromagnetic induction using a bar magnet and a coil
- Dynamos
- Universal generators – functioning principle/operating properties
- Power station generators
- AC/DC generators with electromagnetic stator
- DC motors - functioning principle/power consumption
- DC motors with electromagnetic stator
- Shunt-wound universal motors
- Series-wound universal motors - functioning principle/power consumption
- Synchronous motors
- Electronic motors

COM3LAB Multimedia: Motors & Generators

E2.1.2.1
Basics of Electrical Machines



Basics of Electrical Machines (E2.1.2.1)

Cat. No.	Description	E2.1.2.1
700 24	COM3LAB course: Three-phase technology	1
700 25	COM3LAB course: Electrical machines I	1
700 00USB	COM3LAB master unit (USB)	1
700 00CBTDE	CD: COM3LAB software, German	1
700 00CBTEN	CD: COM3LAB software	1*

* additionally recommended

The experiments are carried out using the multimedia training system COM3LAB.

The COM3LAB course Electrical machines I guides you through the fascinating world of electric motors and generators. Challenging experiments work through the topics of commutator machines, three-phase machines and stepper motors. The board for the course includes a complete machine testing system with which the characteristics of the most important machines can be investigated. The COM3LAB course Three-phase technology discusses the features of multi-phase networks. It forms a basis for understanding three-phase machines such as asynchronous (induction) and synchronous machines.

Objectives

- Recognising basic physical principles
- Recording machine characteristics
- Introduction to drive technology

The equipment set allows students to experiment themselves in a lab equipped with PCs using safety extra-low voltage, which presents no hazard. It is also suitable for demonstration experiments by teachers. Multimedia software explains and monitors how the experiments are carried out.

The target group is made up of commercial apprentices and students of electrical machine technology. The course offers introductory experiments at a simple level and more advanced topics for undergraduate education.

Topics

- Lorentz force
- Machine test system
- Torque/speed characteristics
- DC machines
- Separate excitation/shunt-wound/series-wound machines
- Generator operation
- Power characteristics
- Three-phase machines
- Three-phase windings
- Current and voltage in delta and star (Y) circuits
- Reactance of an AC winding
- Power for a three-phase winding
- Synchronous machines
- Function of a stroboscope
- Asynchronous (induction) machines
- Start-up procedure for three-phase machines
- Manual loading above limit of stability
- Power consumption
- Three-phase drives
- Changing speed by altering stator voltage
- Changing speed by altering synchronous speed
- Changing speed by use of V/f operation
- Stepper motors
- Full steps/half steps

Machine Assembly Kits



E2.1.3.1
ELM Basic Machines
for Extra-Low Voltage

E2.1.3.2
ELM Efficiency Machines
for Extra-Low Voltage

E2.1.3.3
Electrical Machine
Teaching Models
for Extra-Low Voltage

ELM Basic Machines for Extra-Low Voltage (E2.1.3.1)

Cat. No.	Description	E2.1.3.1	E2.1.3.2	E2.1.3.3
563 11	ELM coil, 250 turns	6		6
563 12	ELM squirrel-cage rotor	1		1
563 13	ELM brush	5		5
563 16	Allen key	1	1	1
563 17	ELM centring disc	1		1
563 18	ELM brush holder rack	1		1
563 22	ELM two-pole rotor	1		1
563 23	ELM three-pole rotor	1		1
563 24	ELM drum rotor	1		1
563 25	ELM rotating field attachment and squirrel cage ring	1		1
563 28	ELM magnetic needle rotor	1		1
563 29	ELM aluminium ring with iron disc	1		1
563 31	Oil, 100 ml, in dropping bottle	1	1	1
727 811	Basic machine unit	1	1	1
727 82	Basic terminal unit	1	1	1
727 83	Set of masks	1	1	1
727 85	Starter	1		1
727 86	Field regulator	1		1
727 87	Star-delta load	1	1	1
727 88	Drive unit	1	1	1
685 96	Driving belt, long for drive unit 72788	1	1	1
563 091	ELM pole piece for magnets	2		2
563 101	ELM wide pole piece for coils	3		3
563 115	ELM coil, 500 turns	2		2
563 201	ELM narrow pole piece for coils	6		6
563 211	ELM split pole piece for coils	2		2
505 171	Bulbs, 6 V/1.1 W, E10, set of 10	3		3
505 191	Bulbs, 15 V/2 W, E10, set of 5	3		3
510 48	Magnets, 35 mm Ø, pair	1	1	1
578 16	Capacitor, 4.7 µF, STE 2/19	3		3
579 06	Lamp holder, E10, top, STE 2/19	3	3	3

Cat. No.	Description	E2.1.3.1	E2.1.3.2	E2.1.3.3
579 10	Push button (NO), STE 2/19	1		1
579 13	Toggle switch, STE 2/19	1		1
313 20	Digital hand-held speedometer	1*	1*	1*
524 013S	Sensor-CASSY 2 Starter	1*	1*	1*
531 282	Multimeter Metrahit Pro	2	2	2
726 09	Panel frame T130, two-level	1	1	1
725 721G	Three-phase generator in case	1*	1	1
725 579G	Three-phase supply / experiment transformer	1		1*
563 04	Storage tray for ELM apparatus	1	1	1
500 59	Safety bridging plugs, black, set of 10	1	1	1
500 592	Safety bridging plugs with tap, black, set of 10	1	1	1
501 532	Connecting leads, 19 A, set of 30	1	1	1
775 115DE	LIT: E2.1.3.3 Electrical Machines Teaching Models (German)	1	1	1
775 115EN	LIT: E2.1.3.3 Electrical Machines Teaching Models	1*	1*	1*
727 91	Linear motor basic unit		1	1
727 92	Linear motor with coil assembly		1	1
727 815	ELM set: Multipole stator and rotor		1	1
727 816	ELM PM magnet rotor with inner magnets		1	1
727 812	Rotor position pick-up		1	1

* additionally recommended

The experiments use components from the electrical machine teaching models system and utilise safety extra-low voltage. All machines are mounted on a base unit which is set up vertically in a training panel frame.

Objectives

- Recognising basic physical principles
- Recording machine characteristics
- Introduction to drive technology
- Use of simple tools (spanners, oil cans etc.)

The knowledge gained from these experiments can be directly applied to the area of industrial machines. The electrical machine teaching models for safety extra-low voltage are therefore the ideal preparation for experimenting with commercial industrial machines.

Machine Assembly Kits

E2.1.3.4 Machines with Rotor Kits



Machines with Rotor Kits (E2.1.3.4)

Cat. No.	Description	E2.1.3.4
747 720	3 phase stator	1
747 721	Squirrel cage rotor	1
747 722	Slip-ring rotor	1
747 723	Salient pole rotor	1
747 724	Smooth core rotor	1
747 725	Reluctance rotor	1
747 726	DC shunt stator	1
747 728	DC rotor	1
747 729	Efficiency rotor	1
731 989USB	Machine test system 0.3	1
728 421	CBM10 MOMO/FCCP	1
531 282	Multimeter Metrahit Pro	3
726 09	Panel frame T130, two-level	1
725 852DG	DC machine supply 0.3	1
726 75	Three-phase supply unit with ELCB	1
745 561	Power circuit breaker module	1
731 06	Coupling 0.3	1
731 07	Shaft end guard 0.3	1
731 081	Coupling guard 0.3 transparent	1
500 59	Safety bridging plugs, black, set of 10	1
500 591	Safety bridging plugs, yellow/green, set of 10	1
500 851	Safety connecting leads, 32 A, set of 32	1
500 852	Safety connecting leads, 32 A, yellow/green, set of 10	1
775 190DE	LIT: E2.2.2.0 DC Machines 0.3 (German)	1
775 190EN	LIT: E2.2.2.0 DC Machines 0.3	1*

* additionally recommended

The experiments are carried out with the industrial machine assembly kits.

Objectives

- Protective measures and electrical safety
- Recording machine characteristics
- Set-up of various electrical machines

Machines with interchangeable rotors consist of a stator and various replaceable rotors. An electrical machine in the 300 W power range only comes into existence when the stator and rotor are put together. The stator has a 4-pole three-phase winding to generate the machine flux, along with a drive-end cap and a terminal box. The stator housing is mounted on a base and can be directly connected to the Machine test system 0.3 (731 989USB). A secure connection between stator and rotor is achieved by means of star-grip bolts, which allow for rapid changing of the rotors. No tools are needed. The rotors are equipped with non-drive-end caps, fan, cover and some include slip-rings, brushes etc. In conjunction with the machine testing system, the model machines then exhibit the typical properties of both synchronous and asynchronous (induction) machines. A DC stator with the relevant rotor is also available.

Highlights

- Comparison of efficiencies and characteristics of machines with different rotors
- Simple assembly for rapid set-up and time-effective lab experiments
- Experiments on high-efficiency rotors

The equipment set is suitable both for student experiments in a lab using low voltage (400 V three-phase) and on a mobile trolley for demonstrations by teachers in a classroom. The experiment procedures are contained in a printed manual.

The target group is made up of commercial apprentices and students of electrical machine construction. The course offers experiments at an intermediate level and also allows for the necessary insight into machine behaviour for scientific interpretation at undergraduate level.

Topics

- Recording of torque-speed characteristic
- Determination of nominal ratings for an electrical machine
- Comparison of efficiency for various machines

Machine Assembly Kits

E2.1.3.5
Electrical Machines
Training System



Electrical Machines Training System (E2.1.3.5)

Cat. No.	Description	E2.1.3.5
762 101	System: Electrical machines training system	1
762 102	MPS set: Electrical machines training system*	1

*The MPS set „Electrical machines training system“ (762 102) is not available in all countries. Please contact your local dealer.

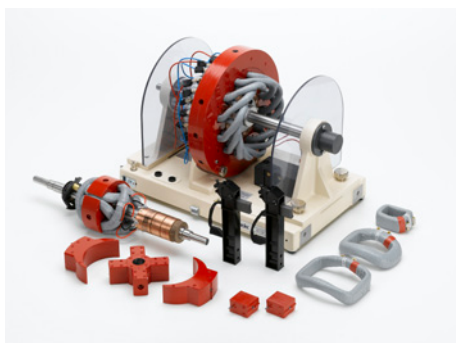

Equipment set above: Electrical Machines Training System (E2.1.3.5)



Equipment set left hand: Machines with Rotor Kits (E2.1.3.4)

The experiments are carried out using assembly kits for the educationally designed electrical machines. This requires simple tools such as screwdrivers and pliers.

Objectives

- Explanation of the components of an electric motor
- Fundamentals of electromagnetism
- DC motors
- Generators
- Series-wound, shunt-wound and compound-wound motors
- Single-phase and three-phase AC motors and generators
- Series-wound, universal and single-phase capacitor motors
- Repulsion, split-phase, shaded-pole and stepper motors
- Faults with electric motors

This training system allows electrical machines to be assembled from individual components and investigated. The topics are highly varied and range from the fundamentals of magnetic fields to commutator and three-phase machines. All the relevant components are visible and only need to be mechanically assembled or electrically connected.

The electrical machine training system utilises the modular concept of the electrical machine teaching models system but using mains voltage (three-phase 400 V). This allows small commercial machines to be assembled step by step in practical laboratory experiments and their ratings can then be determined using the Machine test system 0.3. The procedures for the experiments are contained in a printed manual.

The target group is made up of commercial apprentices and students of power engineering. The course offers experiments at an intermediate level for vocational colleges and undergraduate level.

Topics

- Recording of torque-speed characteristic
- Determination of nominal ratings for an electrical machine
- Comparison of efficiency for various machines

E2 ELECTRICAL DRIVES

E2.2 INDUSTRIAL MACHINES 300 W

E2.2.1 TRANSFORMERS 300 W

- E2.2.1.0 Transformers 0.3
- E2.2.1.1 3-Phase Transformer 0.3
- E2.2.1.2 Scott Transformer 0.3
- E2.2.1.3 AC Transformer 0.3
- E2.2.1.4 AC Toroidal Core Transformer 0.3
- E2.2.1.5 AC Autotransformer 0.3

E2.2.2 DC MACHINES 300 W

- E2.2.2.0 DC Machines 0.3
- E2.2.2.1 DC Compound Machine 0.3
- E2.2.2.2 Universal Motor 0.3

E2.2.3 AC MACHINES 300 W

- E2.2.3.0 AC Machines 0.3
- E2.2.3.1 Universal Motor 0.3
- E2.2.3.2 Capacitor Motor R 0.3
- E2.2.3.3 Capacitor Motor CS Basic 0.3

E2.2.4 3-PHASE INDUCTION MACHINES 300 W

- E2.2.4.0 Induction Machines 0.3
- E2.2.4.1 Squirrel Cage Motor 400/600 0.3
- E2.2.4.2 Squirrel Cage Motor 230/400 0.3
- E2.2.4.3 Slip Ring Motor 0.3
- E2.2.4.4 Squirrel Cage Motor D 0.3
- E2.2.4.5 Squirrel Cage Motor SW 0.3
- E2.2.4.6 Squirrel Cage Motor 400/690 Basic 0.3
- E2.2.4.7 Squirrel Cage Motor 230/400 Basic 0.3
- E2.2.4.8 Squirrel Cage Motor 230/400 Brake Basic 0.3

E2.2.5 3-PHASE SYNCHRONOUS MACHINES 300 W

- E2.2.5.0 Synchronous Machines 0.3
- E2.2.5.1 Salient Pole Rotor 0.3
- E2.2.5.2 Smooth Pole Rotor 0.3

E2.2.6 MECHATRONIC MOTORS 300 W

- E2.2.6.1 Motor with Frequency Converter 0.3
- E2.2.6.2 Brushless DC Machine 0.3

Transformers 300 W



Transformers 0.3 (E2.2.1.0)

Similar to illustration

E2.2.1.0
Transformers 0.3

E2.2.1.1
3-Phase Transformer 0.3

E2.2.1.2
Scott Transformer 0.3

E2.2.1.3
AC Transformer 0.3

E2.2.1.4
AC Toroidal Core Transformer 0.3

E2.2.1.5
AC Autotransformer 0.3

Cat. No.	Description	E2.2.1.0	E2.2.1.1	E2.2.1.2	E2.2.1.3	E2.2.1.4	E2.2.1.5
733 90	Three-phase transformer 0.3	1	1				
733 93	Scott transformer	1		1			
733 97	Single-phase transformer 0.3	1			1		
733 98	AC toroidal core transformer 0.3	1				1	
733 99	AC autotransformer 0.3	1					1
732 40	Resistive load 0.3	1	1	1	1	1	1
732 41	Capacitive load 0.3	1	1	1	1	1	1
732 42	Inductive load 0.3/1.0	1	1	1	1	1	1
531 282	Multimeter Metrahit Pro	3	3	3	3	3	3
727 12	Power factor meter	1	1	1	1	1	1
575 212	Two-channel oscilloscope 400	1	1	1			
575 231	Probe 100 MHz, 1:1 / 10:1	2	2	2			
735 261	Isolation amplifier, four channel	1	1	1			
726 09	Panel frame T130, two-level	1	1	1	1	1	1
726 85	Adjustable transformer 0...260 V	1			1	1	1
725 442DG	Three-phase voltage supply 400 V/2.5 A	1	1	1			
500 59	Safety bridging plugs, black, set of 10	2	2	2	2	2	2
500 591	Safety bridging plugs, yellow/green, set of 10	1	1	1	1	1	1
500 851	Safety connecting leads, 32 A, set of 32	1	1	1	1	1	1
500 852	Safety connecting leads, 32 A, yellow/green, set of 10	1	1	1	1	1	1
775 185DE	LIT: E2.2.1.0 Transformers 0.3 (German)	1	1	1	1	1	1
775 185EN	LIT: E2.2.1.0 Transformers 0.3	1*	1*	1*	1*	1*	1*

* additionally recommended

The experiments are carried out using transformers on training panels in panel frames.

Objectives

- Protective measures and electrical safety
- Set-up of power generation systems according to circuit diagrams
- Use of commercial measuring instruments, hand-held multimeters, oscilloscopes, measuring interfaces

Transformers are magnetically coupled systems used for transforming AC voltages or matching impedance. Transformers can therefore be used primarily for measurement or generation of electric power. These practical exercises study exclusively transformers used in energy generation. Transformer power ratings can range from a few mVA up to several MVA. The size and design also have an important effect on the transformer ratings. Transformers are regarded as electrical machines even though they contain no moving parts. The windings of three-phase transformers can be connected in a variety of circuit configurations.

Students carry out the experiments as specified in the printed manual. Hand-held multimeters are used to measure the characteristics of the transformers. Display of current or voltage against time is particularly interesting for three-phase equipment, although it is not essential. If this aspect is not required, then it is possible to dispense with the oscilloscope, isolating amplifier etc. or Sensor-CASSY. In this case multimeters are sufficient for measuring RMS values.

The target group is made up of commercial apprentices and students of power engineering. The course offers experiments at an intermediate level for vocational colleges and undergraduate level.

The complete equipment set allows for experiments on all the most important types of transformer in the 300 W rating class.

Topics

- Voltage equation and equivalent circuit
- Measurement without load, with load and with a short circuit
- Determination of self-inductance, magnetic coupling and leakage
- Losses, changes in voltage and efficiency

DC Machines 300 W

E2.2.2.0
DC Machines 0.3

E2.2.2.1
DC Compound Machine 0.3

E2.2.2.2
Universal Motor 0.3



DC Machines 0.3 (E2.2.2.0)

Cat. No.	Description	E2.2.2.0	E2.2.2.1	E2.2.2.2
731 86	DC compound machine 0.3	1	1	
732 00	Universal motor 0.3	1		1
731 94	Starter 0.3	1	1	1
732 40	Resistive load 0.3	1	1	1
731 42	On/off switch, three-pole	1	1	1
745 561	Power circuit breaker module	1	1	1
731 95	Field regulator, motor 0.3	1	1	
731 96	Field regulator, generator 0.3	1	1	
731 989USB	Machine test system 0.3	1	1	1
728 421	CBM10 MOMO/FCCP	1	1	1
531 282	Multimeter Metrahit Pro	3	3	2
726 09	Panel frame T130, two-level	1	1	1
725 852DG	DC machine supply 0.3	1	1	1
731 06	Coupling 0.3	1	1	1
731 07	Shaft end guard 0.3	1	1	1
731 081	Coupling guard 0.3 transparent	1	1	1
500 59	Safety bridging plugs, black, set of 10	2	2	2
500 591	Safety bridging plugs, yellow/green, set of 10	1	1	1
500 851	Safety connecting leads, 32 A, set of 32	1	1	1
500 852	Safety connecting leads, 32 A, yellow/green, set of 10	1	1	1
775 190DE	LIT: E2.2.2.0 DC Machines 0.3 (German)	1	1	1
775 190EN	LIT: E2.2.2.0 DC Machines 0.3	1*	1*	1*
732 44	Flywheel 0.3			1*

* additionally recommended

The experiments are carried out using industrial-design machines. All the test machines possess a special base for connecting the Machine test system 0.3. The testing system can be used to record the characteristics of the machines under test. Power for the machines is supplied by special laboratory power supplies.

Objectives

- Protective measures and electrical safety
- Setting up electrical machines and putting them into operation
- Use of starting circuits
- Assessment of electrical machine characteristics

Features

- In order to protect against overheating, the stator windings of the test machines are equipped with temperature sensors
- Should overheating occur, the machine testing system automatically shuts down the machine under test, thus preventing any damage to it.
- The test machines are equipped with an educationally designed terminal board with the winding configuration printed on it.
- The ends of all the windings are connected to the terminal board and can be accessed via 4-mm safety sockets
- Computer-supported acquisition of measurement data provides for meaningful measurement results.

The complete set is equally suitable for student experiments in laboratories with low voltage supplies (230 V AC) and for setting up on a mobile trolley for demonstration by teachers in a classroom. The procedures for the experiments are provided in a printed manual.

The target group is made up of commercial apprentices and students of electrical machine construction. The course offers experiments at an intermediate level and also allows for the necessary insight into machine behaviour for scientific interpretation at undergraduate level.

Topics

- Design and function of DC machines
- Armature reaction and commutation
- Series-wound machines
- Possibilities for changing speed
- Energy conversion
- Shunt-wound machines
- Operation at constant speed
- Self-excitation, etc.

AC Machines 300 W

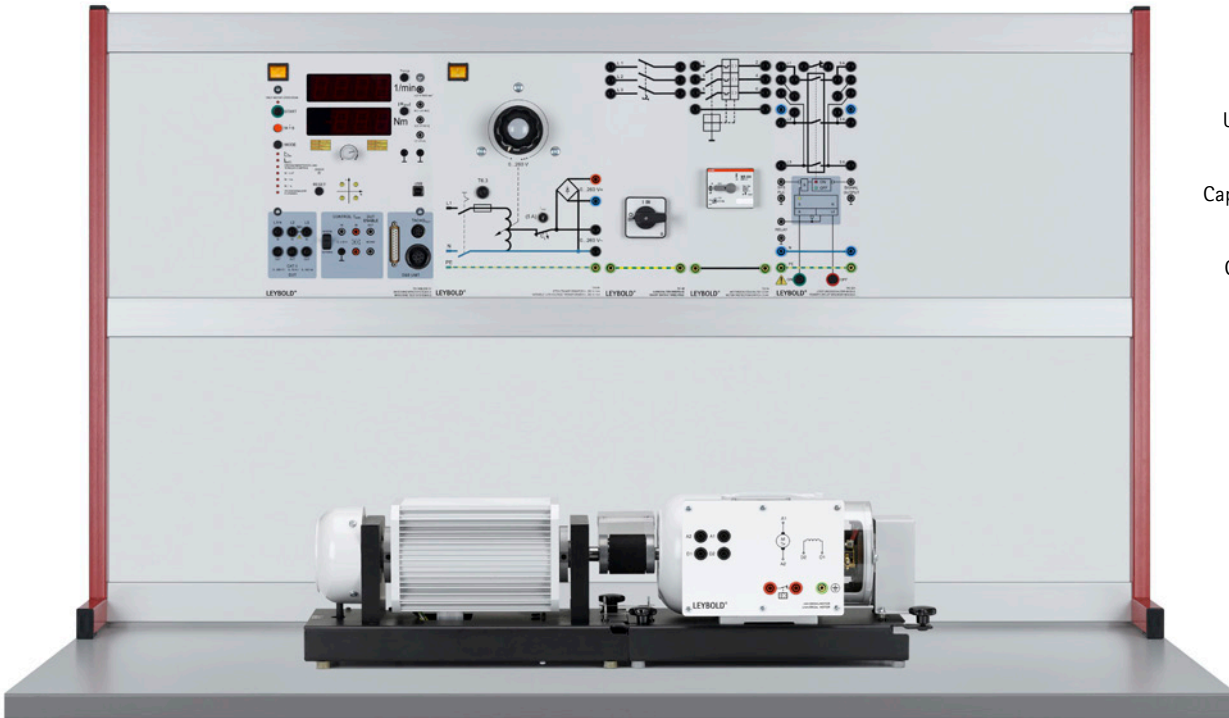

E2.2.3.0
AC Machines 0.3

E2.2.3.1
Universal Motor 0.3

E2.2.3.2
Capacitor Motor R 0.3

E2.2.3.3
Capacitor Motor CS
Basic 0.3

AC Machines 0.3 (E2.2.3.0)

Cat. No.	Description	E2.2.3.0	E2.2.3.1	E2.2.3.2	E2.2.3.3
732 00	Universal motor 0.3	1	1		
732 04	Capacitor motor R 0.3	1		1	
732 204	Capacitor motor CS basic 0.3	1			1
732 14	Motor protection switch, 1-1.6 A	1	1		
732 83	Motor protection switch, 1.6-2.4 A	1		1	1
731 42	On/off switch, three-pole	1	1	1	1
745 561	Power circuit breaker module	1	1	1	1
731 989USB	Machine test system 0.3	1	1	1	1
728 421	CBM10 MOMO/FCCP	1	1	1	1
531 282	Multimeter Metrahit Pro	2	2	2	2
727 12	Power factor meter	1	1	1	1
726 09	Panel frame T130, two-level	1	1	1	1
726 85	Adjustable transformer 0...260 V	1	1	1	1
731 06	Coupling 0.3	1	1	1	1
731 07	Shaft end guard 0.3	1	1	1	1
731 081	Coupling guard 0.3 transparent	1	1	1	1
500 59	Safety bridging plugs, black, set of 10	2	2	2	2
500 591	Safety bridging plugs, yellow/green, set of 10	1	1	1	1
500 851	Safety connecting leads, 32 A, set of 32	1	1	1	1
500 852	Safety connecting leads, 32 A, yellow/green, set of 10	1	1	1	1
775 195DE	LIT: E2.2.3.0 AC Machines 0.3 (German)	1	1	1	1
775 195EN	LIT: E2.2.3.0 AC Machines 0.3	1*	1*	1*	1*

* additionally recommended

The experiments are carried out using machines of industrial manufacture. All the test machines are equipped with a special base for attachment to the Machine test system 0.3. The system allows the characteristics of the machines under test to be recorded. Power for the machines under test is provided via a variable transformer.

Objectives

- Protective measures and electrical safety
- Setting up electrical machines and putting them into operation
- Use of starting circuits
- Assessment of electrical machine characteristics

Features

- In order to protect against overheating, the stator windings of the test machines are equipped with temperature sensors
- Should overheating occur, the machine testing system automatically shuts down the machine under test, thus preventing any damage to it.
- The test machines are equipped with an educationally designed terminal board with the winding configuration printed on it.
- The ends of all the windings are connected to the terminal board and can be accessed via 4-mm safety sockets
- Computer-supported acquisition of measurement data provides for meaningful measurement results.

The complete set is equally suitable for student experiments in laboratories with low voltage supplies (230 V AC) and for setting up on a mobile trolley for demonstration by teachers in a classroom. The procedures for the experiments are provided in a printed manual.

The target group is made up of commercial apprentices and students of electrical machine construction. The course offers experiments at an intermediate level and also allows for the necessary insight into machine behaviour for scientific interpretation at undergraduate level.

In addition to the machines included in the equipment sets, the individual component section of the catalogue also includes special machines such as repulsion motors and auxiliary phase motors, which are available on request.

Topics

- Connection and operation of AC machines
- Reversing direction of rotation
- Measurement of efficiency
- Characteristics of motors
- Load characteristics, etc.

3-Phase Induction Machines 300 W

- E2.2.4.0
Induction Machines 0.3
- E2.2.4.1
Squirrel Cage Motor 400/600 0.3
- E2.2.4.2
Squirrel Cage Motor 230/400 0.3
- E2.2.4.3
Slip Ring Motor 0.3
- E2.2.4.4
Squirrel Cage Motor D 0.3



Induction Machines 0.3 (E2.2.4.0)

Similar to illustration

Cat. No.	Description	E2.2.4.0	E2.2.4.1	E2.2.4.2	E2.2.4.3	E2.2.4.4
732 11	Squirrel cage motor 400/690/0.3	1	1			
732 104	Squirrel cage motor 230/400/0.3	1		1		
732 33	Slip ring motor 0.3	1			1	
732 28	Multi-function machine 0.3	1*				
732 24	Squirrel cage motor D 0.3	1				1
732 26	Squirrel cage motor SW 0.3	1				
732 203	Squirrel cage motor basic 400/690/0.3	1				
732 201	Squirrel cage motor basic 230/400/0.3	1				
732 202	Squirrel cage motor basic 230/400, brake 0.3	1				
726 75	Three-phase supply unit with ELCB	1	1	1	1	1
732 14	Motor protection switch, 1-1.6 A	1	1	1	1	1
731 42	On/off switch, three-pole	1	1	1	1	1
745 561	Power circuit breaker module	1	1	1	1	1
732 40	Resistive load 0.3	1	1	1		
732 41	Capacitive load 0.3	1	1	1	1	
731 47	Star-delta switch	1	1			
731 48	Star-delta reversing switch	1	1*			
731 49	Reversing switch	1	1	1	1*	
731 50	Star-delta starter	1	1*			
731 51	Soft starter 0.3 /1.0	1	1	1	1	
732 29	Rotor starter 0.3	1			1	
731 55	Pole reverser, Dahlander	1				1
731 57	Pole reverser SW	1				
731 65	Blocking gear 0.3	1			1	
731 391	Squirrel cage fault simulator	1*	1	1		
731 989USB	Machine test system 0.3	1	1	1	1	1
728 421	CBM10 MOMO/FCCP	1	1	1	1	1
531 282	Multimeter Metrahit Pro	2	2	2	2	2
727 12	Power factor meter	1	1	1	1	1
531 600	Insulation tester Metrisc C	1*	1	1		
726 09	Panel frame T130, two-level	1	1	1	1	1

Cat. No.	Description	E2.2.4.0	E2.2.4.1	E2.2.4.2	E2.2.4.3	E2.2.4.4
731 06	Coupling 0.3	1	1	1	1	1
731 07	Shaft end guard 0.3	1			1	
731 081	Coupling guard 0.3 transparent	1	1	1	1	1
500 59	Safety bridging plugs, black, set of 10	2	2	2	2	2
500 591	Safety bridging plugs, yellow/green, set of 10	1	1	1	1	1
500 851	Safety connecting leads, 32 A, set of 32	1	1	1	1	1
500 852	Safety connecting leads, 32 A, yellow/green, set of 10	1	1	1	1	1
775 200EN	LIT: E2.2.4.0 Induction Machines 0.3	1*	1*	1*	1*	1*
775 200DE	LIT: E2.2.4.0 Induction Machines 0.3 (German)	1	1	1	1	1

* additionally recommended

The experiments are carried out using machines of industrial manufacture. All the test machines are equipped with a special base for attachment to the Machine test system 0.3. The system allows the characteristics of the machines under test to be recorded. Power for the machines under test is provided either directly from the mains or via special laboratory power supplies.

Objectives

- Protective measures and electrical safety
- Setting up electrical machines and putting them into operation
- Use of starting circuits
- Assessment of electrical machine characteristics

Features

- In order to protect against overheating, the stator windings of the test machines are equipped with temperature sensors
- Should overheating occur, the machine testing system automatically shuts down the machine under test, thus preventing any damage to it.
- The test machines are equipped with an educationally designed terminal board with the winding configuration printed on it.
- The ends of all the windings are connected to the terminal board and can be accessed via 4-mm safety sockets
- Computer-supported acquisition of measurement data provides for meaningful measurement results.

3-Phase Induction Machines 300 W

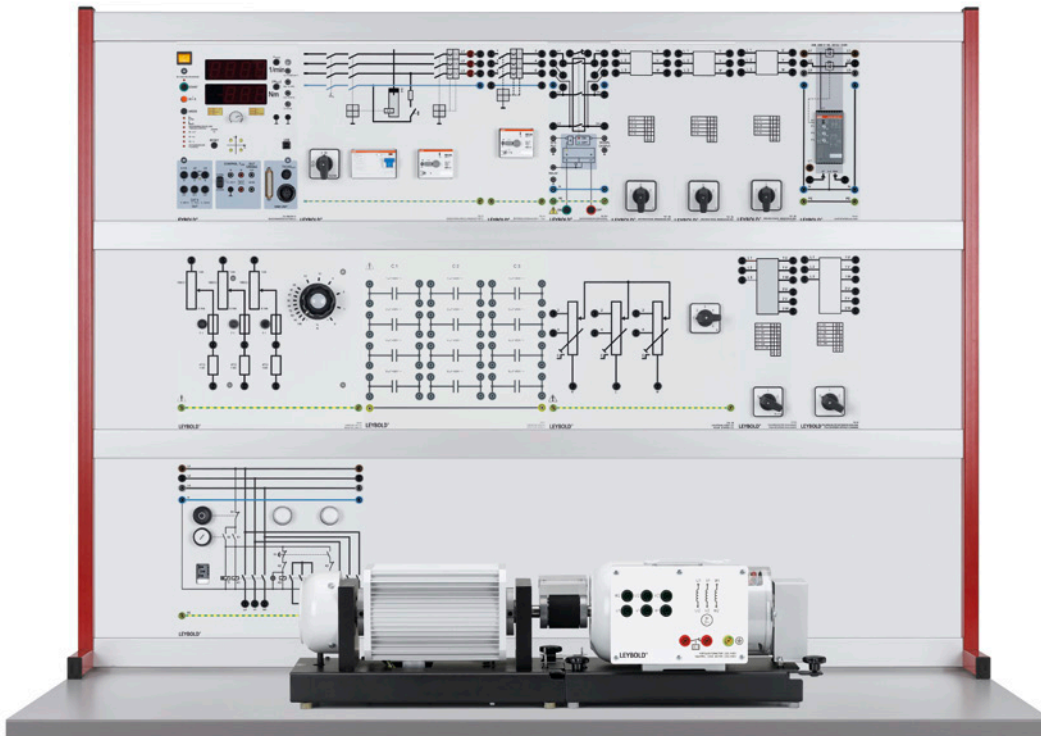

- E2.2.4.5
Squirrel Cage Motor SW 0.3
- E2.2.4.6
Squirrel Cage Motor 400/690
Basic 0.3
- E2.2.4.7
Squirrel Cage Motor 230/400
Basic 0.3
- E2.2.4.8
Squirrel Cage Motor 230/400 Brake
Basic 0.3

Induction Machines 0.3 (E2.2.4.0)

Similar to illustration

Cat. No.	Description	E2.2.4.5	E2.2.4.6	E2.2.4.7	E2.2.4.8
732 26	Squirrel cage motor SW 0.3	1			
726 75	Three-phase supply unit with ELCB	1	1	1	1
732 14	Motor protection switch, 1-1.6 A	1	1	1	1
731 42	On/off switch, three-pole	1	1	1	1
745 561	Power circuit breaker module	1	1	1	1
731 57	Pole reverser SW	1			
731 989USB	Machine test system 0.3	1	1	1	1
728 421	CBM10 MOMO/FCCP	1	1	1	1
531 282	Multimeter Metrahit Pro	2	2	2	2
727 12	Power factor meter	1	1	1	1
726 09	Panel frame T130, two-level	1	1	1	1
731 06	Coupling 0.3	1	1	1	1
500 59	Safety bridging plugs, black, set of 10	2	2	2	2
500 591	Safety bridging plugs, yellow/green, set of 10	1	1	1	1
500 851	Safety connecting leads, 32 A, set of 32	1	1	1	1
500 852	Safety connecting leads, 32 A, yellow/green, set of 10	1	1	1	1
775 200DE	LIT: E2.2.4.0 Induction Machines 0.3 (German)	1	1	1	1
775 200EN	LIT: E2.2.4.0 Induction Machines 0.3	1*	1*	1*	1*
732 203	Squirrel cage motor basic 400/690/0.3		1		
732 40	Resistive load 0.3		1	1	1
732 41	Capacitive load 0.3		1	1	1
731 47	Star-delta switch		1		
731 48	Star-delta reversing switch		1*		
731 49	Reversing switch		1	1	1
731 50	Star-delta starter		1*		
731 51	Soft starter 0.3 /1.0		1	1*	1
731 081	Coupling guard 0.3 transparent		1	1	1
732 201	Squirrel cage motor basic 230/400/0.3			1	
732 202	Squirrel cage motor basic 230/400, brake 0.3				1

* additionally recommended

Basic Drive

- Squirrel cage motors in the Basic Drive class are industrial machines which are supplied with the manufacturers' original terminal board. An illustration of the winding configuration has been deliberately omitted.
- The safety sockets on the terminal board are safely accessible behind a plexi-glass pane.
- The winding terminals are labelled according to international standards.
- Basic Drive machines are supplied with no temperature sensors and need to be protected from overloading by means of a motor protection circuit breaker. The experiments are therefore very similar to industrial practice.
- Basic Drive machines are available exclusively in the 300 W rating class.

The individual equipment set is equally suitable for student experiments in laboratories with low voltage supplies (400 V three-phase) and for setting up on a mobile trolley for demonstration by teachers in a classroom. The procedures for the experiments are provided in a printed manual.

Topics

- Operation of a switchable pole motor with separate windings at low speed and high speed
- Connection and operation of a switchable pole motor with the help of a pole change-over switch
- Recording of characteristics at low speed and high speed
- Design and function
- Characteristics during motor operation
- Starting
- Star-delta starting
- Stator resistance starting circuit
- Braking
- Power performance of an ideal rotating field machine
- Power flux
- Open-circuit experiment
- Short-circuit load experiment
- Design and function of three-phase generator
- Characteristics during generator operation
- Generator slip
- Self-excitation of an induction generator
- Voltage stability
- Insular operation

3-Phase Synchronous Machines 300 W

E2.2.5.0
Synchronous Machines 0.3

E2.2.5.1
Salient Pole Rotor 0.3

E2.2.5.2
Smooth Pole Rotor 0.3

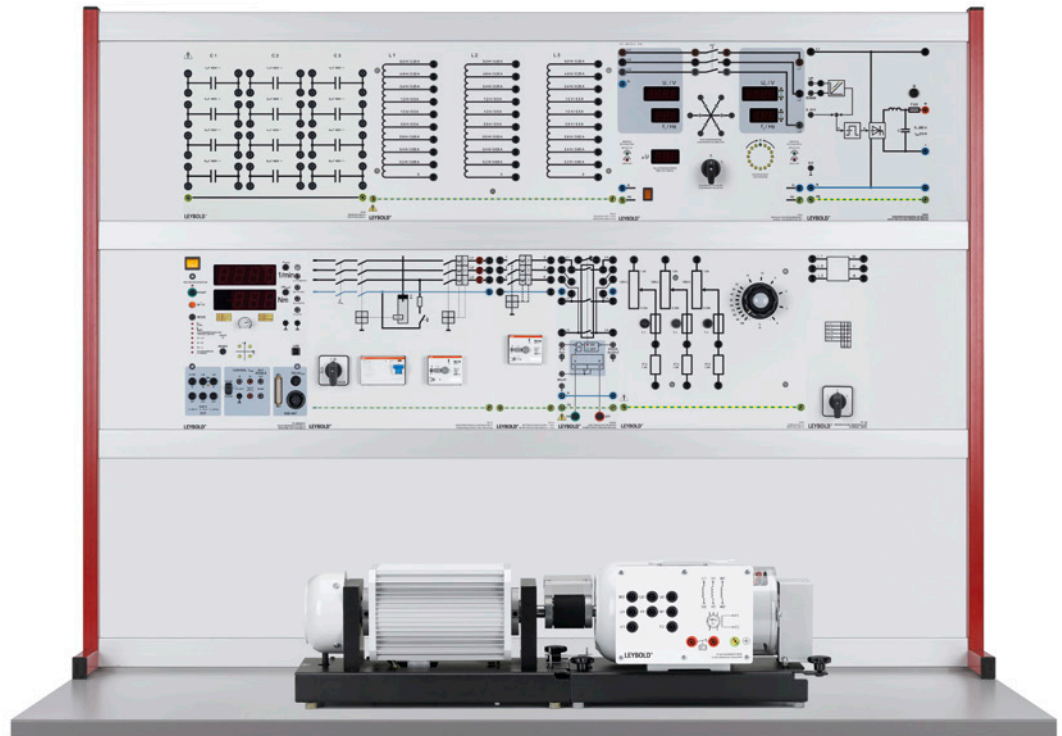

Synchronous Machines 0.3 (E2.2.5.0)

Cat. No.	Description	E2.2.5.0	E2.2.5.1	E2.2.5.2
732 36	Synchronous machine SP 0.3	1	1	
732 37	Synchronous machine SR 0.3	1		1
732 28	Multi-function machine 0.3	1*		
732 40	Resistive load 0.3	1	1	1
732 41	Capacitive load 0.3	1	1	1
732 42	Inductive load 0.3/1.0	1	1	1
726 75	Three-phase supply unit with ELCB	1	1	1
745 05	Manual synchronisation unit	1	1	1
732 14	Motor protection switch, 1-1.6 A	1	1	
745 561	Power circuit breaker module	1	1	1
531 282	Multimeter Metrahit Pro	3	3	3
727 32	Moving iron meter, 2.5 A	1	1	1
727 12	Power factor meter	1	1	1
731 989USB	Machine test system 0.3	1	1	1
728 421	CBM10 MOMO/FCCP	1	1	1
726 09	Panel frame T130, two-level	1	1	1
725 852DG	DC machine supply 0.3	1	1	1
725 352DG	Extra-low voltage supply 24/4	1*		
731 06	Coupling 0.3	1	1	1
731 07	Shaft end guard 0.3	1	1	1
731 081	Coupling guard 0.3 transparent	2	1	1
500 59	Safety bridging plugs, black, set of 10	1	2	2
500 591	Safety bridging plugs, yellow/green, set of 10	1	1	1
500 851	Safety connecting leads, 32 A, set of 32	1	1	1
500 852	Safety connecting leads, 32 A, yellow/green, set of 10	1	1	1
775 205DE	LIT: E2.2.5.0 Synchronous Machines 0.3 (German)	1	1	1
775 205EN	LIT: E2.2.5.0 Synchronous Machines 0.3	1*	1*	1*
731 49	Reversing switch			1

* additionally recommended

The experiments are carried out using machines of industrial manufacture. All the test machines are equipped with a special base for attachment to the Machine test system 0.3. The system allows the characteristics of the machines under test to be recorded. Power for the machines under test is provided either directly from the mains or via special laboratory power supplies.

Objectives

- Protective measures and electrical safety
- Setting up electrical machines and putting them into operation
- Use of starting circuits
- Assessment of electrical machine characteristics

Features

- In order to protect against overheating, the stator windings of the test machines are equipped with temperature sensors
- Should overheating occur, the machine testing system automatically shuts down the machine under test, thus preventing any damage to it.
- The test machines are equipped with an educationally designed terminal board with the winding configuration printed on it.
- The ends of all the windings are connected to the terminal board and can be accessed via 4-mm safety sockets
- Computer-supported acquisition of measurement data provides for meaningful measurement results.

Synchronous motor topics

- Non-salient-pole and salient-pole rotors
- Voltage equations
- Equivalent circuit and vector diagram
- Operation with no-load and with a permanent three-pole short-circuit
- Locus diagrams and control characteristics
- Torque and loading
- Potier diagram and armature reaction
- Synchronisation and use of multiple machines in parallel
- Starting methods for synchronous motors
- Control of reactive power
- Power performance

Synchronous generator topics

- Voltage generation
- Excitation of synchronous machines
- Operating response
- Armature current and torque
- Braking operation and locus diagrams
- Starting and synchronisation
- Single-phase generators

Mechatronic Motors 300 W

E2.2.6.1
Motor with
Frequency Converter 0.3

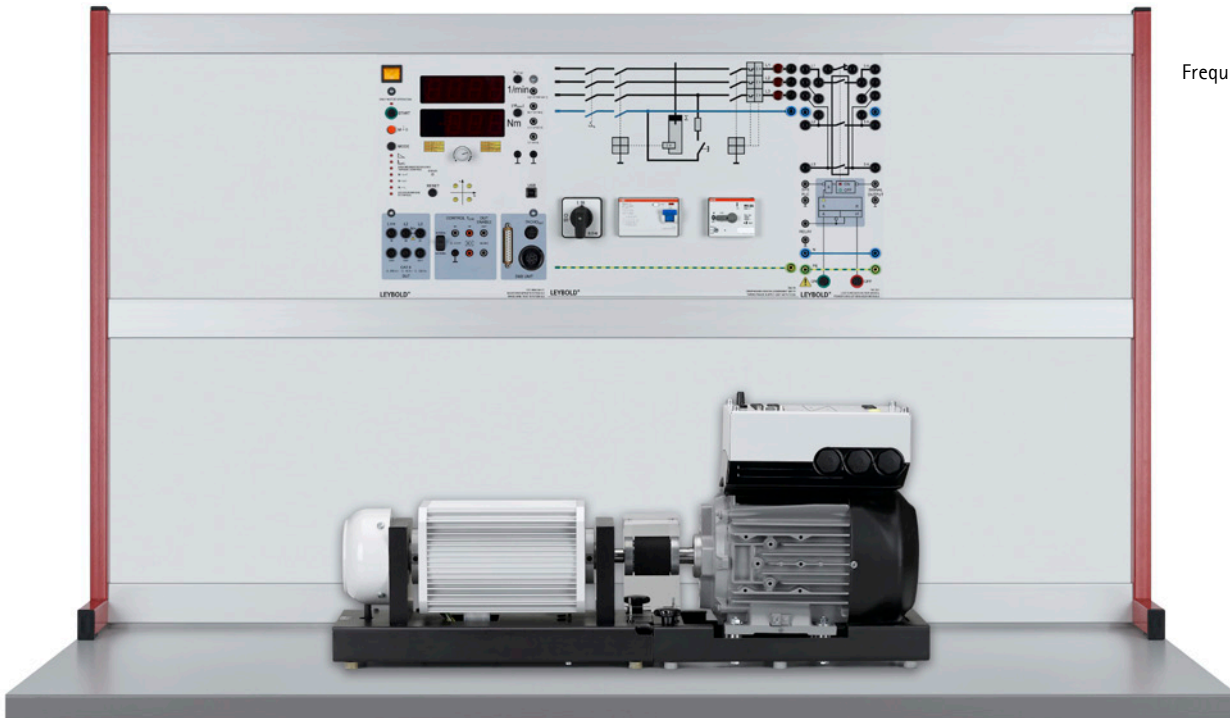

Motor with Frequency Converter 0.3 (E2.2.6.1)

Similar to illustration

Cat. No.	Description	E2.2.6.1
732 46	Frequency converter motor 0.3	1
735 314	LCP2 local control panel	1
531 282	Multimeter Metrahit Pro	3
731 989USB	Machine test system 0.3	1
728 421	CBM10 MOMO/FCCP	1
726 09	Panel frame T130, two-level	1
726 75	Three-phase supply unit with ELCB	1
731 06	Coupling 0.3	1
731 081	Coupling guard 0.3 transparent	1
500 59	Safety bridging plugs, black, set of 10	1
500 591	Safety bridging plugs, yellow/green, set of 10	1
500 854	Safety leads, set of 20	1
735 315USB	USB/RS 485 interface converter	1*
775 350DE	LIT: E2.2.6.1 Motor with Frequency Converter 0.3 (German)	1
775 350EN	LIT: E2.2.6.1 Motor with Frequency Converter 0.3	1*

* additionally recommended

The experiments are carried out using machines of industrial manufacture. All the test machines are equipped with a special base for attachment to the Machine test system 0.3. The system allows the characteristics of the machines under test to be recorded. Power for the machines under test is provided either directly from the mains or via special laboratory power supplies.

Objectives

- Protective measures and electrical safety
- Setting up electrical machines and putting them into operation
- Use of starting circuits
- Assessment of electrical machine characteristics

The machine to be tested is an industrial frequency converter motor consisting of a four-pole asynchronous three-phase motor with a power rating of 0.55 kW including an integrated frequency converter. The motor and the converter are optimally fine-tuned to one another. The experiment investigates the features of the operating response in comparison to other types of machine without built-in power electronics. More advanced topics such as positioning control or non-linear load characteristics (winding machines, fans etc.) are investigated in E2.6, Servo technology.

Features

- In order to protect against overheating, the stator windings of the test machines are equipped with temperature sensors
- Should overheating occur, the machine testing system automatically shuts down the machine under test, thus preventing any damage to it.
- The test machines are equipped with an educationally designed terminal board with the winding configuration printed on it.
- The ends of all the windings are connected to the terminal board and can be accessed via 4-mm safety sockets
- Computer-supported acquisition of measurement data provides for meaningful measurement results.

The individual equipment set is equally suitable for student experiments in laboratories with low voltage supplies (400 V three-phase) and for setting up on a mobile trolley for demonstration by teachers in a classroom. The procedures for the experiments are provided in a printed manual.

The target group is made up of commercial apprentices and students of electrical machine construction. The course offers experiments at an intermediate level and also allows for the necessary insight into machine behaviour for scientific interpretation at undergraduate level.

Topics

- Design and function of a frequency converter controlled motor
- Operation with a power amplifier
- Run-up and operating characteristics
- How speed depends on frequency
- How speed depends on load: fan, pump, winding machine, flywheel

Mechatronic Motors 300 W

E2.2.6.2
Brushless
DC Machine 0.3

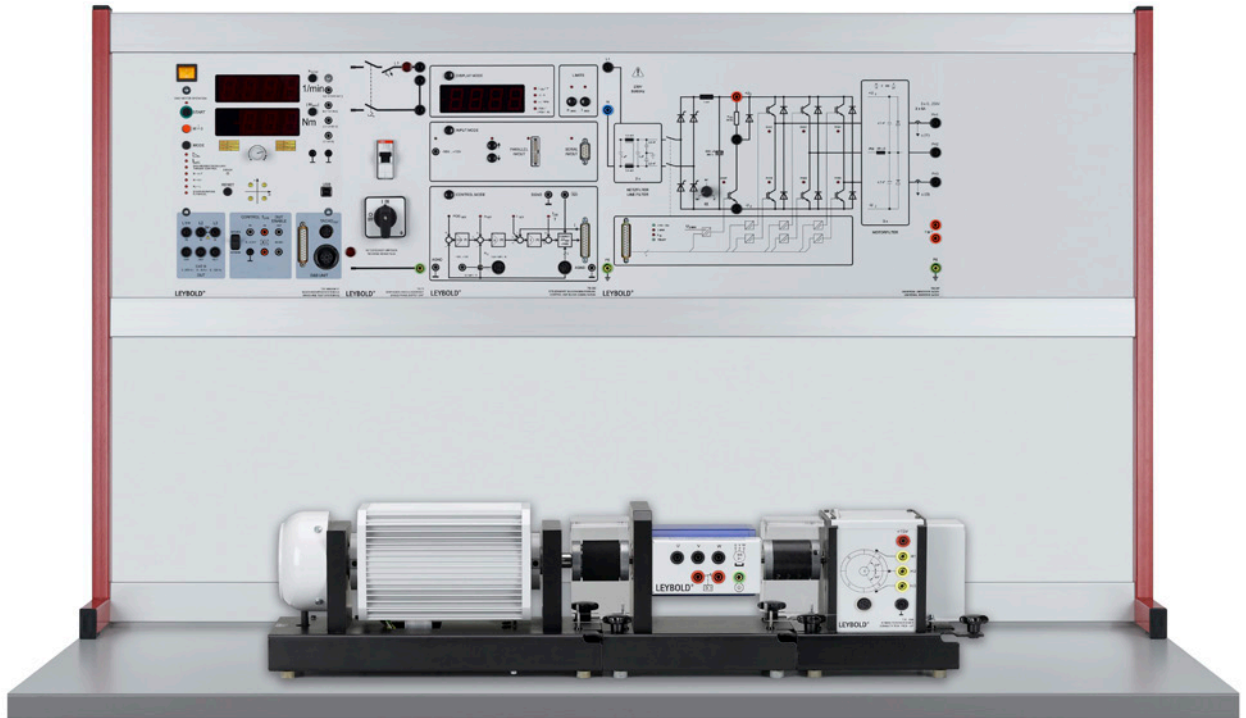

Brushless DC Machine 0.3 (E2.2.6.2)

Cat. No.	Description	E2.2.6.2
731 096	Commutation pick-up 0.3	1
731 994	AC servo motor 0.3	1
735 292	Control unit block commutation	1
735 297	Universal converter 3 x 230 V	1
537 35	Rheostat, 330 ohms	1
531 282	Multimeter Metrahit Pro	2
731 989USB	Machine test system 0.3	1
728 421	CBM10 MOMO/FCCP	1
726 09	Panel frame T130, two-level	1
726 75	Three-phase supply unit with ELCB	1
731 06	Coupling 0.3	1
731 07	Shaft end guard 0.3	1
731 081	Coupling guard 0.3 transparent	1
500 59	Safety bridging plugs, black, set of 10	1
500 591	Safety bridging plugs, yellow/green, set of 10	1
500 851	Safety connecting leads, 32 A, set of 32	1
500 852	Safety connecting leads, 32 A, yellow/green, set of 10	1
775 305DE	LIT: E2.6.2.1 AC Servo with Block Commutation (German)	1
775 305EN	LIT: E2.6.2.1 AC Servo with Block Commutation	1*

* additionally recommended

The experiments are carried out using machines of industrial manufacture. All the test machines are equipped with a special base for attachment to the Machine test system 0.3. The system allows the characteristics of the machines under test to be recorded. Power for the machines under test is provided either directly from the mains or via special laboratory power supplies.

Objectives

- Protective measures and electrical safety
- Setting up electrical machines and putting them into operation
- Use of starting circuits
- Assessment of electrical machine characteristics

Mechatronics machines are used in the field of automation. They are distinguished by their area of application, whereby the physical operating principle is unimportant. AC servo motors (synchronous machine) and frequency converter motors (asynchronous machine) are both used. Mechatronics machines of small to medium power carry out positioning tasks. Control of the machines always requires power electronics components.

Features

- In order to protect against overheating, the stator windings of the test machines are equipped with temperature sensors
- Should overheating occur, the machine testing system automatically shuts down the machine under test, thus preventing any damage to it.
- The test machines are equipped with an educationally designed terminal board with the winding configuration printed on it.
- The ends of all the windings are connected to the terminal board and can be accessed via 4-mm safety sockets
- Computer-supported acquisition of measurement data provides for meaningful measurement results.

The individual equipment set is equally suitable for student experiments in laboratories with low voltage supplies (400 V three-phase) and for setting up on a mobile trolley for demonstration by teachers in a classroom. The procedures for the experiments are provided in a printed manual.

The target group is made up of commercial apprentices and students of electrical machine construction. The course offers experiments at an intermediate level and also allows for the necessary insight into machine behaviour for scientific interpretation at undergraduate level.

Topics

- Design and function
- Operation with a power amplifier
- How current and voltage change over time
- Load characteristics
- Automatic or closed-loop current, speed and positioning control
- Dynamics and changing direction of rotation
- Variable speed and load

E2 ELECTRICAL DRIVES

E2.3 INDUSTRIAL MACHINES 1 KW

E2.3.1 TRANSFORMERS 1 KW

- E2.3.1.0 Transformers 1.0
- E2.3.1.1 3-Phase Transformer 1.0
- E2.3.1.2 Scott Transformer 0.3
- E2.3.1.3 AC Transformer 0.3
- E2.3.1.4 AC Toroidal Core Transformer 0.3
- E2.3.1.5 AC Autotransformer 0.3

E2.3.2 DC MACHINES 1 KW

- E2.3.2.0 DC Machines 1.0
- E2.3.2.1 DC Compound Machine 1.0
- E2.3.2.2 Universal Motor 1.0

E2.3.3 AC MACHINES 1 KW

- E2.3.3.0 AC Machines 1.0
- E2.3.3.1 Universal Motor 1.0
- E2.3.3.2 Capacitor Motor R 1.0

E2.3.4 3-PHASE INDUCTION MACHINES 1 KW

- E2.3.4.0 Induction Machines 1.0
- E2.3.4.1 Squirrel Cage Motor 400/600 1.0
- E2.3.4.2 Squirrel Cage Motor 230/400 1.0
- E2.3.4.3 Slip Ring Motor 1.0
- E2.3.4.4 Squirrel Cage Motor D 1.0
- E2.3.4.5 Squirrel Cage Motor SW 1.0

E2.3.5 3-PHASE SYNCHRONOUS MACHINES 1 KW

- E2.3.5.0 Synchronous Machines 1.0
- E2.3.5.1 Salient Pole Rotor 1.0
- E2.3.5.2 Smooth Core Rotor 1.0

E2.3.6 MECHATRONIC MOTORS 1 KW

- E2.3.6.1 Motor with Frequency Converter 1.0

Transformers 1 kW

E2.3.1.0
Transformers 1.0

E2.3.1.1
3-Phase Transformer 1.0

E2.3.1.2
Scott Transformer 0.3

E2.3.1.3
AC Transformer 0.3

E2.3.1.4
AC Toroidal Core Transformer 0.3

E2.3.1.5
AC Autotransformer 0.3

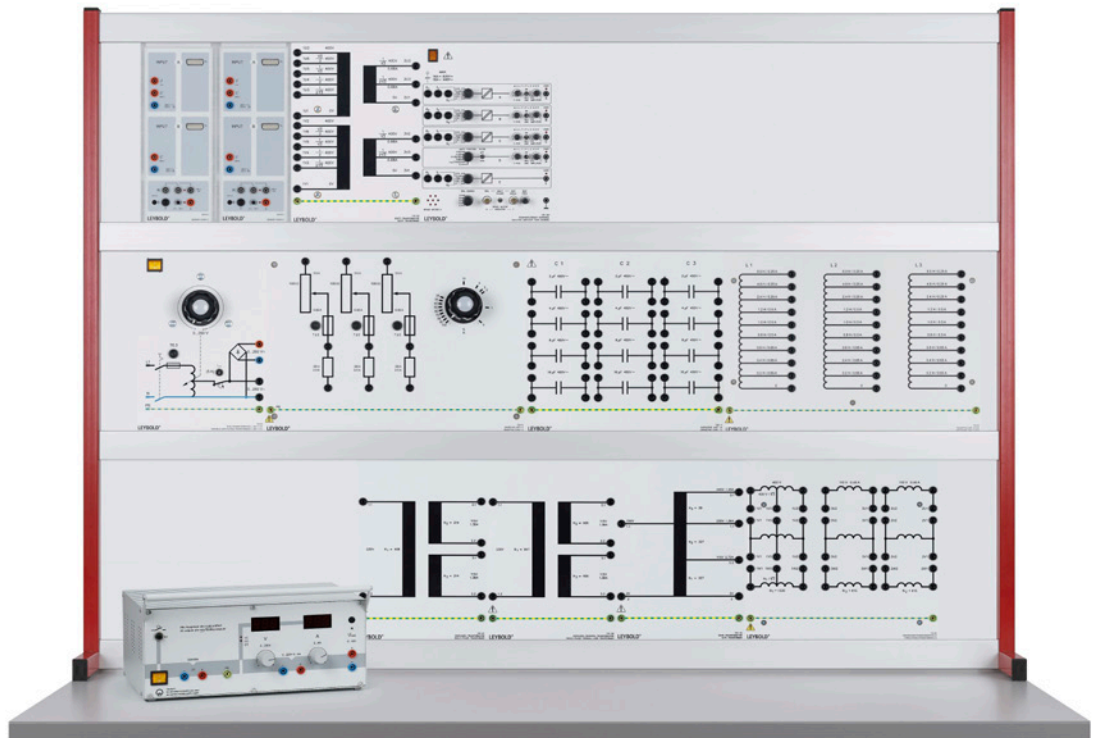

Transformers 1.0 (E2.3.1.0)

Similar to illustration

Cat. No.	Description	E2.3.1.0	E2.3.1.1	E2.3.1.2	E2.3.1.3	E2.3.1.4	E2.3.1.5
733 91	Three-phase transformer 1.0	1	1				
733 93	Scott transformer	1		1			
733 97	Single-phase transformer 0.3	1			1		
733 98	AC toroidal core transformer 0.3	1				1	
733 99	AC autotransformer 0.3	1					1
733 10	Resistive load 1.0	1	1	1	1	1	1
732 41	Capacitive load 0.3	1			1	1	1
732 42	Inductive load 0.3/1.0	1			1	1	1
531 282	Multimeter Metrahit Pro	3	3	3	3	3	3
727 12	Power factor meter	1	1	1	1	1	1
575 212	Two-channel oscilloscope 400	1	1	1			
575 231	Probe 100 MHz, 1:1 / 10:1	2	2	2			
735 261	Isolation amplifier, four channel	1	1	1			
726 09	Panel frame T130, two-level	1	1	1	1	1	1
725 442DG	Three-phase voltage supply 400 V/2.5 A	1	1	1			
500 59	Safety bridging plugs, black, set of 10	2	2	2	2	2	2
500 591	Safety bridging plugs, yellow/green, set of 10	1	1	1	1	1	1
500 851	Safety connecting leads, 32 A, set of 32	1	1	1	1	1	1
500 852	Safety connecting leads, 32 A, yellow/green, set of 10	1	1	1	1	1	1
775 220DE	LIT: E2.3.1.0 Transformers 1.0 (German)	1	1	1*	1*	1*	1*
775 220EN	LIT: E2.3.1.0 Transformers 1.0	1*	1*				
726 85	Adjustable transformer 0...260 V				1	1	1

* additionally recommended

The experiments are carried out using transformers on training panels in panel frames.

Objectives

- Protective measures and electrical safety
- Set-up of power generation systems according to circuit diagrams
- Use of commercial measuring instruments, hand-held multimeters, oscilloscopes, measuring interfaces

Transformers are magnetically coupled systems used for transforming AC voltages or matching impedance. Transformers can therefore be used primarily for measurement or generation of electric power. These practical exercises study exclusively transformers used in energy generation. Transformer power ratings can range from a few mVA up to several MVA. The size and design also have an important effect on the transformer ratings. Transformers are regarded as electrical machines even though they contain no moving parts. The windings of three-phase transformers can be connected in a variety of circuit configurations.

Students carry out the experiments as specified in the printed manual. Hand-held multimeters are used to measure the characteristics of the transformers. Display of current or voltage against time is particularly interesting for three-phase equipment, although it is not essential. If this aspect is not required, then it is possible to dispense with the oscilloscope, isolating amplifier etc. or Sensor-CASSY. In this case multimeters are sufficient for measuring RMS values.

The target group is made up of commercial apprentices and students of power engineering. The course offers experiments at an intermediate level for vocational colleges and undergraduate level.

The complete equipment set allows for experiments on all the most important types of transformer.

Topics

- Voltage equation and equivalent circuit
- Measurement without load, with load and with a short circuit
- Determination of self-inductance, magnetic coupling and leakage
- Losses, changes in voltage and efficiency

DC Machines 1kW

E2.3.2.0
DC Machines 1.0

E2.3.2.1
DC Compound Machine 1.0

E2.3.2.2
Universal Motor 1.0



DC Machines 1.0 (E2.3.2.0)

Cat. No.	Description	E2.3.2.0	E2.3.2.1	E2.3.2.2
732 60	DC multi-function machine 1.0	1	1	
733 14	Flywheel 1.0	1*	1*	1*
732 70	Universal motor 1.0	1		1
733 10	Resistive load 1.0	1	1	
732 64	Starter 1.0	1	1	
732 65	Field regulator, motor 1.0	1	1	
732 66	Field Regulator Generator 1.0	1	1	
731 42	On/off switch, three-pole	1	1	1
745 561	Power circuit breaker module	1	1	1
531 282	Multimeter Metrahit Pro	3	3	2
732 689USB	Machine test system 1.0	1	1	1
728 421	CBM10 MOMO/FCCP	1	1	1
726 09	Panel frame T130, two-level	1	1	1
725 862DG	DC machine supply 1.0	1	1	1
732 56	Coupling 1.0	1	1	1
732 57	Shaft end guard 1.0	1	1	1
732 58	Coupling guard 1.0	1	1	1
500 59	Safety bridging plugs, black, set of 10	2	2	2
500 591	Safety bridging plugs, yellow/green, set of 10	1	1	1
500 851	Safety connecting leads, 32 A, set of 32	1	1	1
500 852	Safety connecting leads, 32 A, yellow/green, set of 10	1	1	1
501 45	Connecting lead, 19 A, 50 cm, red/blue, pair	1	1	1
775 225DE	LIT: E2.3.2.0 DC Machines 1.0 (German)	1	1	1
775 225EN	LIT: E2.3.2.0 DC Machines 1.0	1*	1*	1*

* additionally recommended

The experiments are carried out using industrial-design machines. All the test machines possess a special base for connecting the Machine test system 1.0. The testing system can be used to record the characteristics of the machines under test. Power for the machines is supplied either via the mains or by special laboratory power supplies.

Objectives

- Protective measures and electrical safety
- Setting up electrical machines and putting them into operation
- Use of starting circuits
- Assessment of electrical machine characteristics

Features

- In order to protect against overheating, the stator windings of the machines to be tested are equipped with temperature sensors
- Should overheating occur the machine testing system automatically shuts down the test machine, thus preventing any damage to it.
- The machines to be tested are equipped with an educationally designed terminal board with the winding configuration printed on it.
- The ends of all the windings are connected to the terminal board and can be accessed via 4-mm safety sockets
- Computer-supported acquisition of measurement data provides for meaningful measurement results.
- Machines in the 1 kW rating class have a powerful and realistic operating response
- In comparison to smaller machines, their characteristics display distinctive features related to the design.

Topics

- Design and function of DC machines
- Armature reaction and commutation
- Series-wound machines
- Possibilities for changing speed
- Energy conversion
- Shunt-wound machines
- Operation at constant speed
- Self-excitation
- Current-voltage characteristics
- Load characteristics
- Possibilities for changing speed and adjusting for load
- Starting and braking
- Characteristics of generators
- Power performance

AC Machines 1 kW

E2.3.3.0
AC Machines 1.0

E2.3.3.1
Universal Motor AC 1.0

E2.3.3.2
Capacitor Motor R 1.0



AC Machines 1.0 (E2.3.3.0)

Cat. No.	Description	E2.3.3.0	E2.3.3.1	E2.3.3.2
732 70	Universal motor 1.0	1	1	
732 74	Capacitor motor R 1.0	1		1
733 14	Flywheel 1.0	1	1*	1*
731 42	On/off switch, three-pole	1	1	1
745 561	Power circuit breaker module	1	1	1
733 54	Motor protection switch, 6-10 A	1	1	1
531 282	Multimeter Metrahit Pro	2	2	2
727 12	Power factor meter	1	1	1
732 689USB	Machine test system 1.0	1	1	1
728 421	CBM10 MOMO/FCCP	1	1	1
726 09	Panel frame T130, two-level	1	1	1
726 85	Adjustable transformer 0...260 V	1	1	
732 56	Coupling 1.0	1	1	1
732 57	Shaft end guard 1.0	1	1	1
732 58	Coupling guard 1.0	1	1	1
501 45	Connecting lead, 19 A, 50 cm, red/blue, pair	5	5	5
500 59	Safety bridging plugs, black, set of 10	2	2	2
500 591	Safety bridging plugs, yellow/green, set of 10	1	1	1
500 851	Safety connecting leads, 32 A, set of 32	1	1	1
500 852	Safety connecting leads, 32 A, yellow/green, set of 10	1	1	2
775 230DE	LIT: E2.3.3.0 AC Machines 1.0 (German)	1	1	1
775 230EN	LIT: E2.3.3.0 AC Machines 1.0	1*	1*	1*
726 71	Single-phase supply unit			1

* additionally recommended

The experiments are carried out using industrial-design machines. All the machines under test possess a special base for connecting the Machine test system 1.0. The testing system can be used to record the characteristics of the machines under test. Power for the machines is supplied either via a variable transformer.

Objectives

- Protective measures and electrical safety
- Setting up electrical machines and putting them into operation
- Use of starting circuits
- Assessment of electrical machine characteristics

Features

- In order to protect against overheating, the stator windings of the machines to be tested are equipped with temperature sensors
- Should overheating occur the machine testing system automatically shuts down the test machine, thus preventing any damage to it.
- The machines to be tested are equipped with an educationally designed terminal board with the winding configuration printed on it.
- The ends of all the windings are connected to the terminal board and can be accessed via 4-mm safety sockets
- Computer-supported acquisition of measurement data provides for meaningful measurement results.
- Machines in the 1 kW rating class have a powerful and realistic operating response
- In comparison to smaller machines, their characteristics display distinctive features related to the design.

The complete equipment set is equally suitable for student experiments in laboratories with low voltage supplies (400 V three-phase) and for setting up on a mobile trolley for demonstration by teachers in a classroom. The procedures for the experiments are provided in a printed manual.

Topics

- Connection and operation of AC machines
- Reversing direction of rotation
- Measurement of efficiency
- Characteristics of motors
- Load characteristics

3-Phase Induction Machines 1 kW

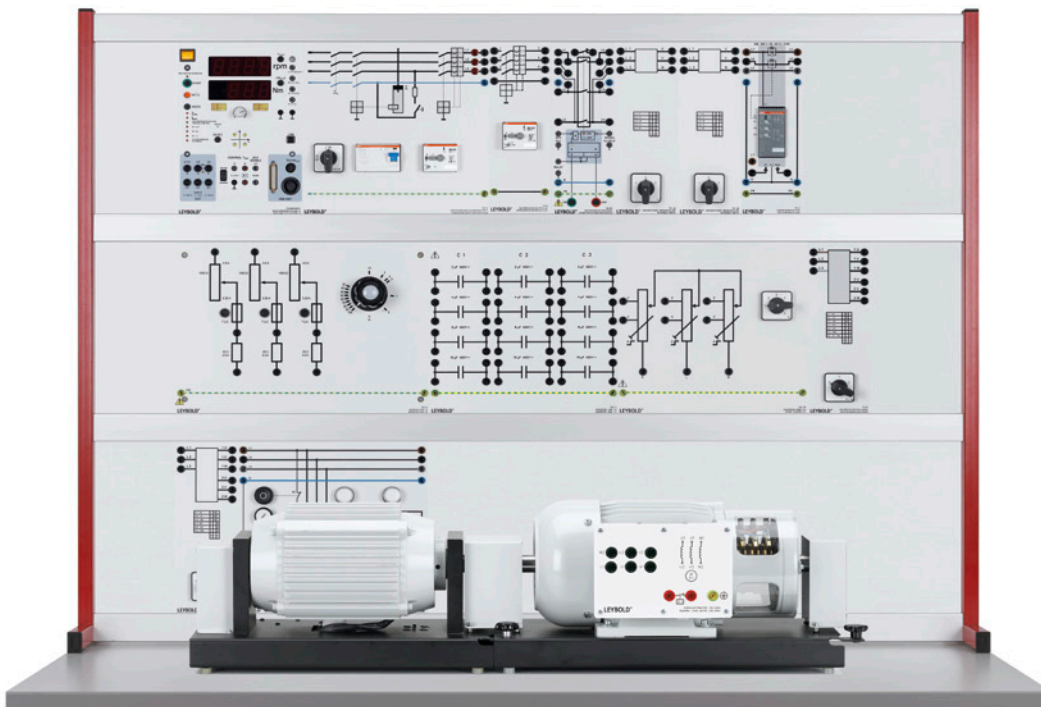

- E2.3.4.0
Induction Machines 1.0
- E2.3.4.1
Squirrel Cage Motor 400/600 1.0
- E2.3.4.2
Squirrel Cage Motor 230/400 1.0
- E2.3.4.3
Slip Ring Motor 1.0
- E2.3.4.4
Squirrel Cage Motor D 1.0
- E2.3.4.5
Squirrel Cage Motor SW 1.0

Induction Machines 1.0 (E2.3.4.0)

Cat. No.	Description	E2.3.4.0	E2.3.4.1	E2.3.4.2	E2.3.4.3	E2.3.4.4	E2.3.4.5
732 81	Squirrel cage motor 400/690 1.0	1	1				
732 804	Squirrel cage motor 230/400 1.0	1		1			
733 03	Slip ring motor 1.0	1			1		
732 94	Squirrel cage motor D 1.0	1				1	
732 96	Squirrel cage motor SW 1.0	1					1
731 50	Star-delta starter	1	1*				
731 47	Star-delta switch	1	1				
731 48	Star-delta reversing switch	1	1*				
731 49	Reversing switch	1	1	1			
731 55	Pole reverser, Dahlander	1				1	
731 57	Pole reverser SW	1					1
732 99	Rotor starter 1.0	1			1		
733 10	Resistive load 1.0	1	1	1			
733 11	Capacitive load 1.0	1	1	1			
733 05	Blocking Gear Mechanism 1.0	1			1		
731 391	Squirrel cage fault simulator	1	1*	1*			
731 51	Soft starter 0.3 /1.0	1	1				
745 561	Power circuit breaker module	1	1	1	1	1	1
732 83	Motor protection switch, 1.6-2.4 A	1		1		1	1
531 600	Insulation tester MetrISO C	1	1*	1*			
531 282	Multimeter Metrahit Pro	3	2	2	3	2	2
727 12	Power factor meter	1	1	1	1	1	1
732 689USB	Machine test system 1.0	1	1	1	1	1	1
728 421	CBM10 MOMO/FCCP	1	1	1	1	1	1
726 75	Three-phase supply unit with ELCB	1	1	1	1	1	1
726 09	Panel frame T130, two-level	1	1	1	1	1	1
732 56	Coupling 1.0	1	1	1	1	1	1
732 57	Shaft end guard 1.0	1	1	1	2	1	1
732 58	Coupling guard 1.0	1	1	1	1	1	1
501 45	Connecting lead, 19 A, 50 cm, red/blue, pair	5	5	5	5	5	5

Cat. No.	Description	E2.3.4.0	E2.3.4.1	E2.3.4.2	E2.3.4.3	E2.3.4.4	E2.3.4.5
500 59	Safety bridging plugs, black, set of 10	2	2	2	2	2	2
500 591	Safety bridging plugs, yellow/green, set of 10	1	1	1	1	1	1
500 851	Safety connecting leads, 32 A, set of 32	1	1	1	1	1	1
500 852	Safety connecting leads, 32 A, yellow/green, set of 10	1	1	1	1	1	1
775 235DE	LIT: E2.3.4.0 Induction Machines 1.0 (German)	1	1	1	1	1	1
775 235EN	LIT: E2.3.4.0 Induction Machines 1.0	1*	1*	1*	1*	1*	1*
732 84	Motor protection switch, 2.4-4 A		1	1	1		

* additionally recommended

The experiments are carried out using industrial-design machines. All the test machines possess a special base for connecting the Machine test system 1.0. The testing system can be used to record the characteristics of the machines under test. Power for the machines is supplied either via the mains or by special laboratory power supplies.

Objectives

- Protective measures and electrical safety
- Setting up electrical machines and putting them into operation
- Use of starting circuits
- Assessment of electrical machine characteristics

Topics for motor operation

- Design and function
- Operating characteristics
- Starting: slip-ring rotors, deep-bar squirrel cage rotors, star-delta starting, switching via a starting transformer, stator resistance starting circuit
- Braking: regenerative braking, DC braking, dynamic lowering circuit
- Power performance of an ideal rotating field machine
- Power flux
- Locus (Heyland circle) diagram
- Experiment without any load
- Short-circuit load experiment

3-Phase Synchronous Machines 1 kW

E2.3.5.0
Synchronous Machines 1.0

E2.3.5.1
Salient Pole Rotor 1.0

E2.3.5.2
Smooth Core Rotor 1.0

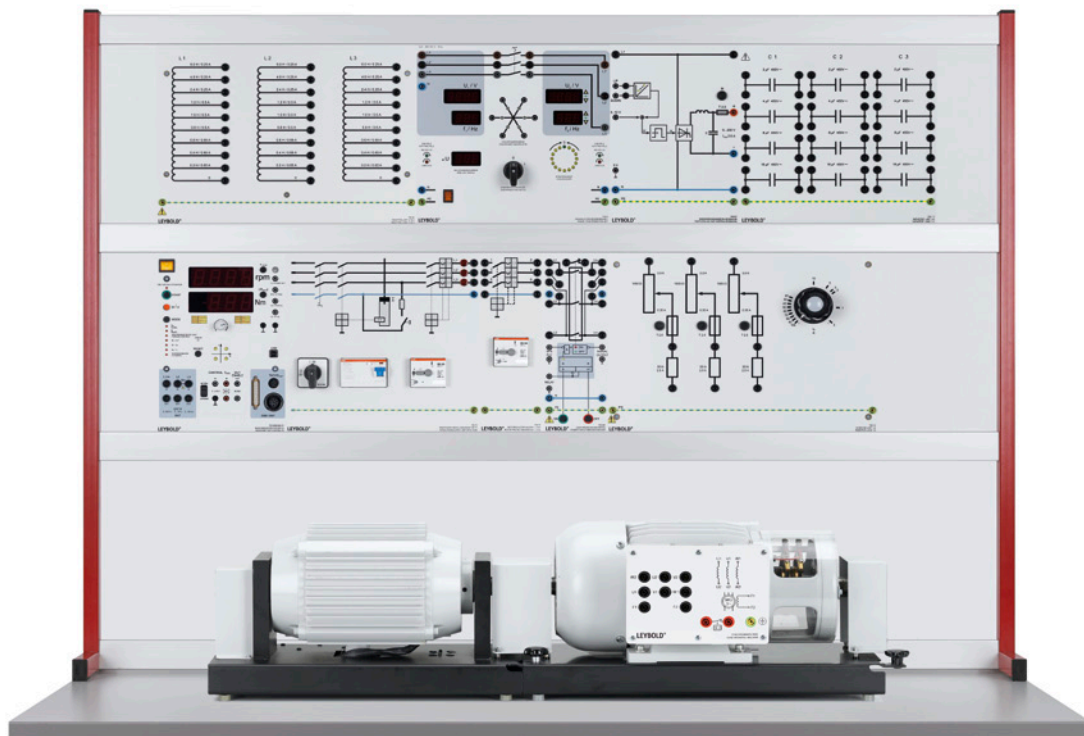

Synchronous Machines 1.0 (E2.3.5.0)

Cat. No.	Description	E2.3.5.0	E2.3.5.1	E2.3.5.2
733 06	Synchronous machine SP 1.0	1	1	
733 07	Synchronous machine SC 1.0	1		1
745 05	Manual synchronisation unit	1	1	1
733 10	Resistive load 1.0	1	1	1
733 11	Capacitive load 1.0	1	1	1
732 42	Inductive load 0.3/1.0	1	1	1
745 561	Power circuit breaker module	1	1	1
732 83	Motor protection switch, 1.6–2.4 A	1	1	1
727 32	Moving iron meter, 2.5 A	1	1	1
531 282	Multimeter Metrahit Pro	3	3	3
727 12	Power factor meter	1	1	1
732 689USB	Machine test system 1.0	1	1	1
728 421	CBM10 MOMO/FCCP	1	1	1
726 75	Three-phase supply unit with ELCB	1	1	1
725 862DG	DC machine supply 1.0	1	1	1
726 09	Panel frame T130, two-level	1	1	1
732 56	Coupling 1.0	1	1	1
732 57	Shaft end guard 1.0	1	1	1
732 58	Coupling guard 1.0	1	1	1
501 45	Connecting lead, 19 A, 50 cm, red/blue, pair	5	5	5
500 59	Safety bridging plugs, black, set of 10	2	2	2
500 591	Safety bridging plugs, yellow/green, set of 10	1	1	1
500 851	Safety connecting leads, 32 A, set of 32	1	1	1
500 852	Safety connecting leads, 32 A, yellow/green, set of 10	1	1	1
775 240DE	LIT: E2.3.5.0 Synchronous Machines 1.0 (German)	1	1	1
775 240EN	LIT: E2.3.5.0 Synchronous Machines 1.0	1*	1*	1*
731 42	On/off switch, three-pole			1

* additionally recommended

The experiments are carried out using industrial-design machines. All the test machines possess a special base for connecting the Machine test system 1.0. The testing system can be used to record the characteristics of the machines

under test. Power for the machines is supplied either via the mains or by special laboratory power supplies.

Objectives

- Protective measures and electrical safety
- Setting up electrical machines and putting them into operation
- Use of starting circuits
- Assessment of electrical machine characteristics

Features

- In order to protect against overheating, the stator windings of the machines to be tested are equipped with temperature sensors
- Should overheating occur the machine testing system automatically shuts down the test machine, thus preventing any damage to it.
- The machines to be tested are equipped with an educationally designed terminal board with the winding configuration printed on it.
- The ends of all the windings are connected to the terminal board and can be accessed via 4-mm safety sockets
- Computer-supported acquisition of measurement data provides for meaningful measurement results.
- Machines in the 1 kW rating class have a powerful and realistic operating response
- In comparison to smaller machines, their characteristics display distinctive features related to the design.

Synchronous motor topics

- Non-salient-pole and salient-pole rotors
- Voltage equations
- Equivalent circuit and vector diagram
- Operation with no-load and with a permanent three-pole short-circuit
- Locus diagrams and control characteristics
- Torque and loading
- Potier diagram and armature reaction
- Synchronisation and use of multiple machines in parallel
- Starting methods for synchronous motors
- Control of reactive power
- Power performance

Synchronous generator topics

- Voltage generation
- Excitation of synchronous machines
- Operating response
- Armature current and torque
- Braking operation and locus diagrams
- Starting and synchronisation
- Single-phase generators

Mechatronic Motors 1 kW

E2.3.6.1
Motor with
Frequency Converter 1.0



Motor with Frequency Converter 1.0 (E2.3.6.1)

Cat. No.	Description	E2.3.6.1
732 49	Motor with FCC 1.0	1
735 314	LCP2 local control panel	1
732 689USB	Machine test system 1.0	1
728 421	CBM10 MOMO/FCCP	1
726 09	Panel frame T130, two-level	1
726 75	Three-phase supply unit with ELCB	1
732 56	Coupling 1.0	1
732 58	Coupling guard 1.0	1
500 59	Safety bridging plugs, black, set of 10	1
500 591	Safety bridging plugs, yellow/green, set of 10	1
500 854	Safety leads, set of 20	1
735 315USB	USB/RS 485 interface converter	1*
775 355DE	LIT: E2.3.6.1 Motor with Frequency Converter 1.0 (German)	1
775 355EN	LIT: E2.3.6.1 Motor with Frequency Converter 1.0	1*

* additionally recommended

The experiments are carried out using industrial-design machines. All the test machines possess a special base for connecting the Machine test system 1.0. The testing system can be used to record the characteristics of the machines under test. Power for the machines is supplied either via the mains or by special laboratory power supplies.

Objectives

- Protective measures and electrical safety
- Setting up electrical machines and putting them into operation
- Use of starting circuits
- Assessment of electrical machine characteristics

The test machine is an industrial frequency converter motor consisting of a four-pole asynchronous three-phase motor with a power rating of 1.1 kW and an integrated frequency converter. The motor and the converter are optimally fine-tuned to one another. The experiment investigates the features of the

operating response in comparison to other types of machine without built-in power electronics. More advanced topics such as positioning control or non-linear load characteristics (winding machines, fans etc.) are investigated in E2.6 Servo technology using 300 W machines.

Features

- In order to protect against overheating, the stator windings of the machines to be tested are equipped with temperature sensors
- Should overheating occur the machine testing system automatically shuts down the test machine, thus preventing any damage to it.
- The machines to be tested are equipped with an educationally designed terminal board with the winding configuration printed on it.
- The ends of all the windings are connected to the terminal board and can be accessed via 4-mm safety sockets
- Computer-supported acquisition of measurement data provides for meaningful measurement results.
- Machines in the 1 kW rating class have a powerful and realistic operating response
- In comparison to smaller machines, their characteristics display distinctive features related to the design.

The equipment set is suitable both for student experiments in a lab using low voltage (400 V three-phase) and on a mobile trolley for demonstrations by teachers in a classroom. The experiment procedures are contained in a printed manual.

The target group is made up of commercial apprentices and students of electrical machine construction. The course offers experiments at an intermediate level and also allows for the necessary insight into machine behaviour for scientific interpretation at undergraduate level.

Topics

- Design and function of a frequency converter controlled motor
- Operation with a power amplifier
- Run-up and operating characteristics
- How speed depends on frequency
- How speed depends on load: fan, pump, winding machine, flywheel



E2 ELECTRICAL DRIVES

E2.4 POWER ELECTRONICS

E2.4.1 COMPACT SYSTEMS FOR POWER ELECTRONICS

E2.4.1.1 Power Electronics with the Plug-In System

E2.4.1.2 COM3LAB Multimedia: Power Electronics

E2.4.2 LINE-COMMUTATED CONVERTERS

E2.4.2.1 Static Converter Valves

E2.4.2.2 Fault Simulator, Phase Control

E2.4.3 SELF-COMMUTATED CONVERTERS

E2.4.3.1 Switchable Valves and DC choppers

E2.4.3.2 Switched-Mode Power Supplies

E2.4.3.3 Inverters

Compact Systems for Power Electronics

E2.4.1.1
Power Electronics with the Plug-In System

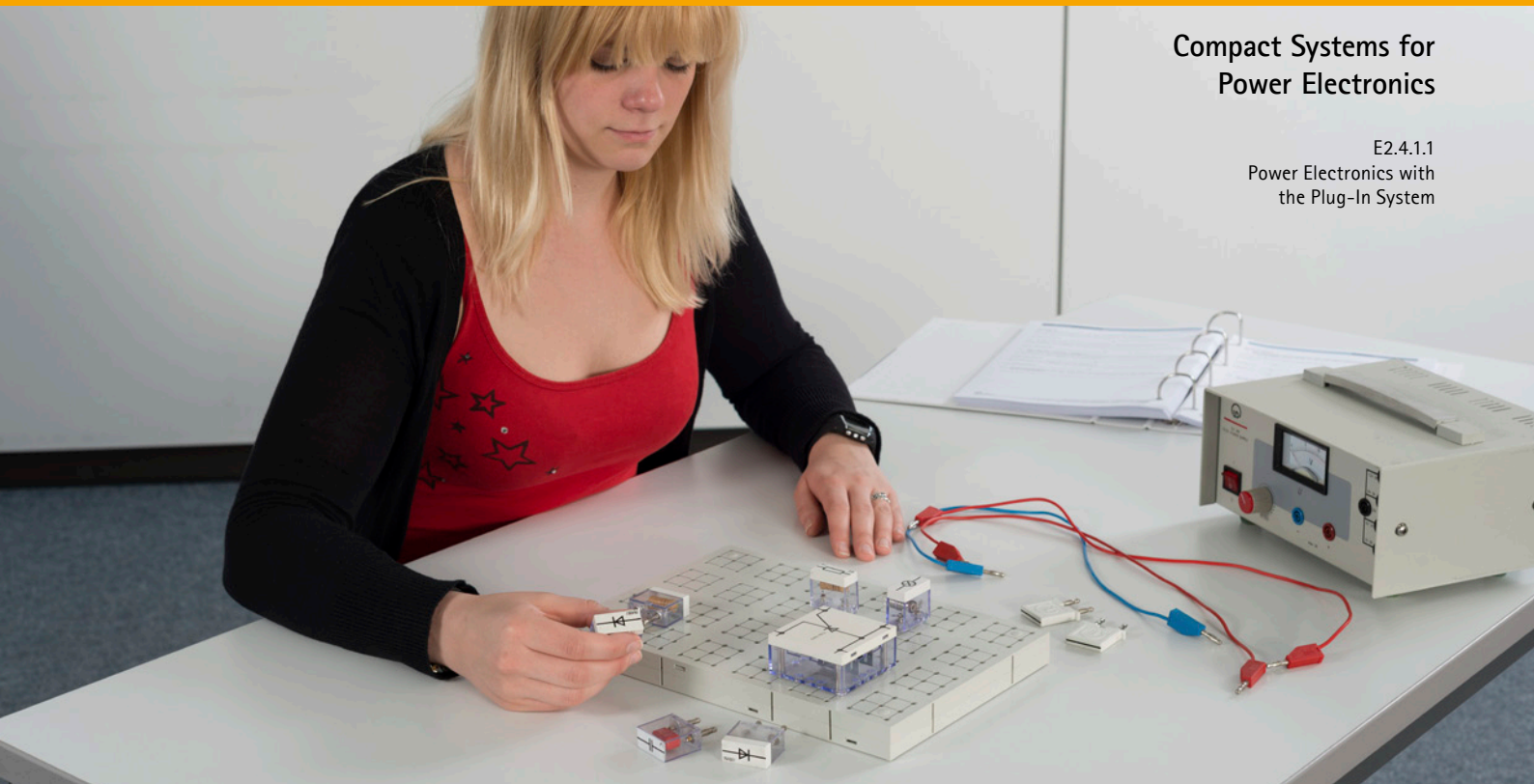

Power Electronics with the Plug-In System (E2.4.1.1)

Cat. No.	Description	E2.4.1.1
727 531N	Basic set STE 6.1.1	1
727 657N	Supplementary set T 6.1.18	1
726 50	Plug-in board, 297 mm x 300 mm, STE	1*
521 485	AC/DC power supply, 0...12 V/3 A	1
522 621	Function generator S 12	1
726 962	Function generator 200 kHz	1*
562 791	Plug-in power supply, 12 V AC	1*
531 57	Multimeter METRAport 3A	1*
531 282	Multimeter Metrahit Pro	1*
531 172	Digital multimeter DMM120	1
575 212	Two-channel oscilloscope 400	1
575 231	Probe 100 MHz, 1:1 / 10:1	2
501 48	Bridging plugs, STE 2/19, set of 10	3
501 532	Connecting leads, 19 A, set of 30	1
726 19	Panel frame SL85, single-level	1*
726 88	AC/DC stabilizer	1*
727 510N	Complete equipment set DC/AC/EL	1*
775 175DE	LIT: E2.4.1.1 STE Power Electronics (German)	1
775 175EN	LIT: E2.4.1.1 STE Power Electronics	1*

* additionally recommended

The experiments are carried out using the STE plug-in system Electricity/Electronics.

Objectives

- Recognition of basic physical principles
- Implementation of electrical circuits according to circuit diagrams

The power electronics is an important area within electrical engineering. It links power engineering with control technology and electronics. The advances in the production of semiconductor power devices such as diodes, thyristors, triacs and power transistors have essentially promoted their breakthrough. The main task of power electronics is the switching, controlling and transforming of electrical energy with the help of electronic components.

Student experiments with the plug-in system for power electronics investigate the characteristics of power semiconductors as well as basic standard circuits. All experiments work with single-phase, safety extra-low voltage. The necessary prerequisites for successful running the course are knowledge of AC theory, semiconductor technology and experience in handling the oscilloscope.

The target group is made up of students in general or vocational education. The experiments are designed as an introduction at a simple level of understanding. To gain a deeper understanding, experiments with the compact system E2.4.2.1, static converter valves and the COM3LAB courses on power electronics are ideal.

Topics

- Components of power electronics
- Characteristics of thyristors, triacs and diacs
- Thyristors used as DC switches and choppers
- Pulse generators and trigger circuits
- Phase angle control
- Circuits with thyristor trigger components
- Circuits with dimmers: touch dimmers, light dimmers
- Thyristor DC quenching
- Zero-voltage switches
- Full-wave control

Compact Systems for Power Electronics

E2.4.1.2
COM3LAB Multimedia:
Power Electronics

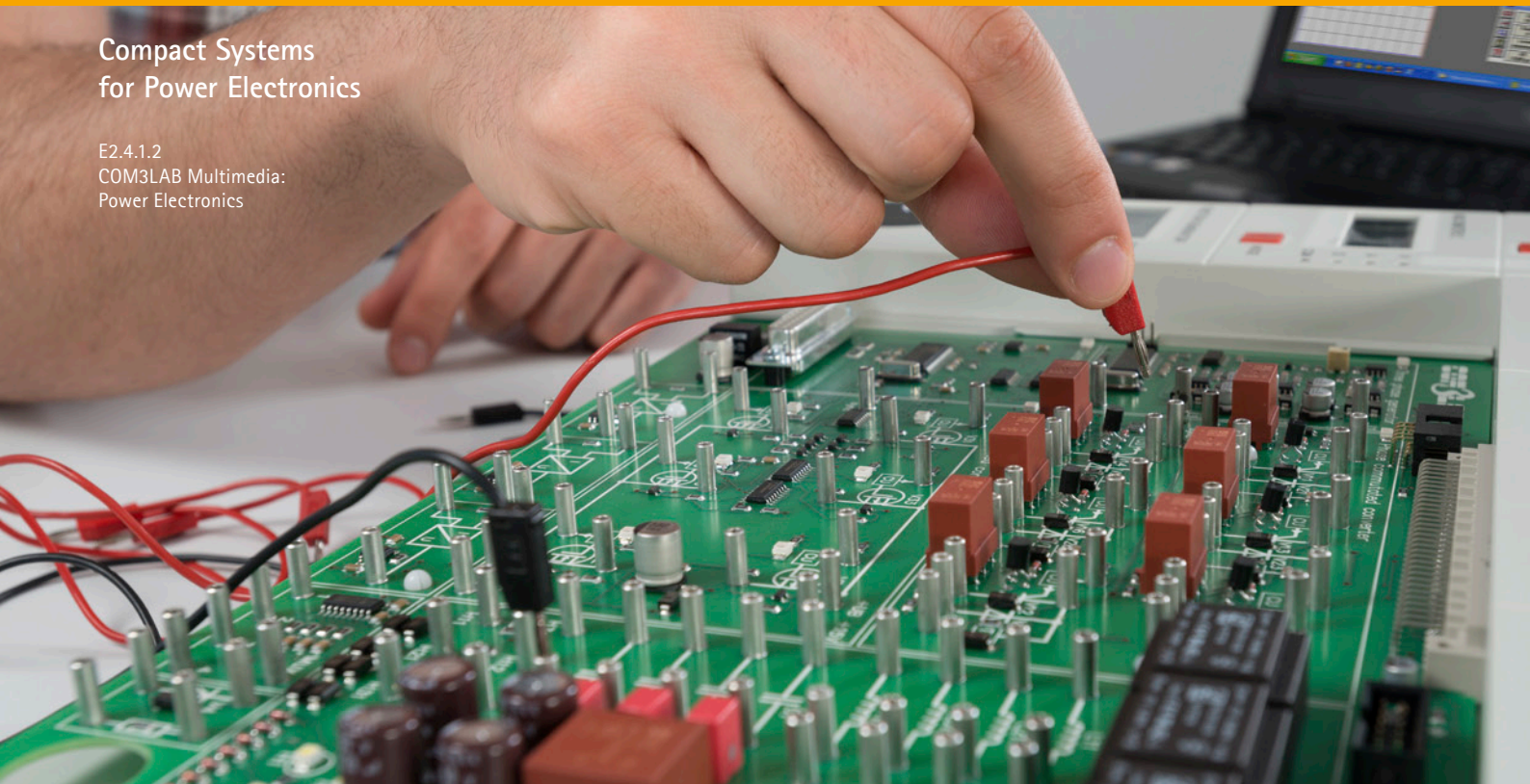

COM3LAB Multimedia: Power Electronics (E2.4.1.2)

Cat. No.	Description	E2.4.1.2
700 21	COM3LAB course: Power electronics I	1
700 22	COM3LAB course: Power electronics II	1
700 00USB	COM3LAB master unit (USB)	1
700 00CBTDE	CD: COM3LAB software (German)	1*
700 00CBTEN	CD: COM3LAB software	1
735 297	Universal converter 3 x 230 V	1*
735 290	Connecting lead universal converter	1*
732 104	Squirrel cage motor 230/400/0.3	1*
731 07	Shaft end guard 0.3	1*
726 71	Single-phase supply unit	1*
500 59	Safety bridging plugs, black, set of 10	1*
500 851	Safety connecting leads, 32 A, set of 32	1*
726 19	Panel frame SL85, single-level	1*

* additionally recommended

The COM3LAB courses on power electronics convey the topic in concentrated form to deepen understanding. Characteristics of power semiconductors and the basic standard circuits are investigated. All the experiments work with single-phase safety extra-low voltage, which is non-hazardous. Only small amounts of materials and little space are needed for the experiments. A student desk with a PC is entirely sufficient.

Objectives

- Basic physical principles of power semiconductors
- Design of key basic circuits for power electronics
- Assessment of properties of rectifiers and converters

The equipment set allows students to experiment themselves in a lab equipped with PCs using safety extra-low voltage, which presents no hazard. It is also suitable for demonstration experiments by teachers. Multimedia software explains and monitors how the experiments are carried out.

The target group mainly consists of trainee industrial or jobbing electricians. The systems can also be used for vocational further education.

To gain a deeper understanding, experiments with the compact system E2.4.2.1, Static converter valves, is ideal.

In project lessons an asynchronous machine (732 104) is operated without a load and supplied with three-phase power (3 x 230 V) via a universal converter (735 297) The parameters for the converter can be set via an interface panel on the board itself which connects directly to the COM3LAB course.

Topics

- Semiconductors in power electronics
- Wiring and control
- Switching processes and commutation
- Uncontrolled rectifier circuits
- Characteristic values for periodic signals
- Controlled line-commutated converters
- Circuits: M1C, M3C, B2C, B6C
- Semi-controlled rectifiers
- Self-commutated converters
- Semiconductor switches and choppers
- Switches and actuators for DC
- Inverters
- Static converters for closed-loop control
- Static converters for drive technology

Line-Commutated Converters

E2.4.2.1
Static Converter Valves

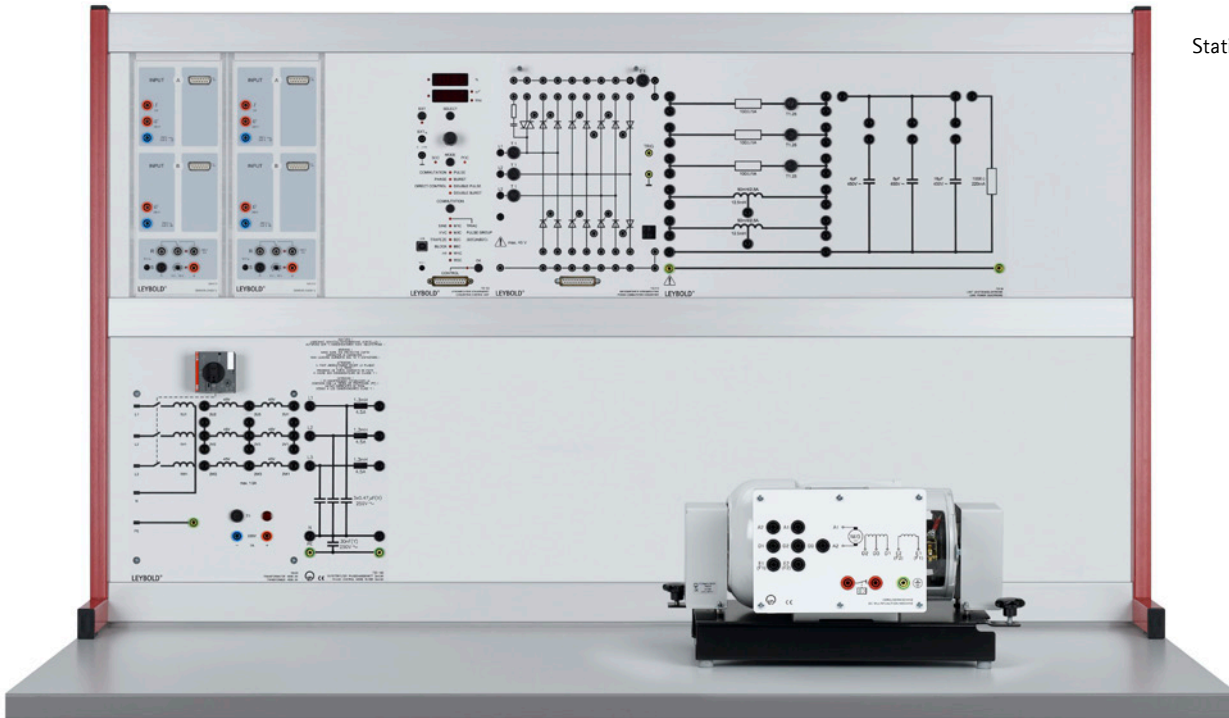

Static Converter Valves (E2.4.2.1)

Cat. No.	Description	E2.4.2.1
735 09	Load for power electronics	1
735 012	Line-commutated converter	1
735 122	Converter controller unit	1
735 190	Phase control noise filter 3 x 4.5 A	1
524 013S	Sensor-CASSY 2 Starter	1
524 013	Sensor-CASSY 2	1
531 282	Multimeter Metrahit Pro	2
726 09	Panel frame T130, two-level	1
726 80	Transformer, 45/90, 3 N	1
500 59	Safety bridging plugs, black, set of 10	2
500 851	Safety connecting leads, 32 A, set of 32	1
500 852	Safety connecting leads, 32 A, yellow/green, set of 10	1
775 250DE	LIT: E2.4.2.1 Static Converter Valves (German)	1
731 07	Shaft end guard 0.3	2*
731 86	DC compound machine 0.3	1*
775 250EN	LIT: E2.4.2.1 Static Converter Valves	1*

* additionally recommended

The experiments are set up with the help of training panels in panel frames. The static converters with overlay masks show the block circuit diagram and a signal flow plan. They also allow the experiment circuits to be set up in clear fashion. The central, microprocessor-monitored trigger lines allow the converter circuits to be changed quickly.

Objectives

- Measurement of characteristic variables such as average and root-mean-square values, form factor and ripple
- Phase angle control or pulse group control
- Protective equipment, commutation, control characteristics

Power electronics has developed from the technology of static converters to become one of the most important and all-encompassing areas of electrical

engineering. The job of power electronics is to switch, control and convert electrical energy using power semiconductors with the best possible efficiency. One key application is drive technology. With the help of modern power electronics it is possible to construct variable-speed drives in DC and three-phase circuits for 4-quadrant operation. Nowadays thyristor speed regulation equipment, smooth starting circuits, frequency converters, servo drives etc. are indispensable in industry, skilled electrical work or households.

The equipment set is suitable both for student experiments in a lab using low voltage (400 V three-phase) and on a mobile trolley for demonstrations by teachers in a classroom. The experiment procedures are contained in a printed manual.

The target group is made up of commercial apprentices and students of electrical machine technology. The course offers introductory experiments at a simple level and more advanced topics for undergraduate education.

Topics

- Single static converters and bidirectional static converters with various loads (R, L, RL)
- Resistive-inductive load with freewheeling diode
- Resistive-inductive load with reverse voltage
- Resistive-capacitive load
- Triac AC power controller
- Fully controlled three-phase power controller
- Semi-controlled three-phase power controller
- Three-phase power controller with two bidirectional pairs
- Controlled rectifier mid-point circuits
- Two-pulse centre-tap control
- Controlled six-pulse centre-tap control, M6
- M6 circuit with resistive load
- M6 circuit with resistive-inductive load
- Controlled bridge rectifier circuits with various loads
- Two-pulse bridge circuit
- Six-pulse bridge circuit
- Fully controlled two-pulse bridge circuit, B2C

Line-Commutated Converters

E2.4.2.2
Fault Simulator,
Phase Control



Fault Simulator, Phase Control (E2.4.2.2)

Cat. No.	Description	E2.4.2.2
735 390	Fault simulator for phase control	1
505 27	Bulb, 230 V/40 W, E14	3
729 09	Lamp sockets E14, set of three	1
735 190	Phase control noise filter 3 x 4.5 A	1
501 02	BNC cable, 1 m	2
531 282	Multimeter Metrahit Pro	1
735 261	Isolation amplifier, four channel	1
575 231	Probe 100 MHz, 1:1 / 10:1	2
575 230	Digital storage oscilloscope 722	1
726 09	Panel frame T130, two-level	1
726 80	Transformer, 45/90, 3 N	1
500 59	Safety bridging plugs, black, set of 10	1
500 851	Safety connecting leads, 32 A, set of 32	1
500 852	Safety connecting leads, 32 A, yellow/green, set of 10	1
775 255DE	LIT: E2.4.2.2 Fault Simulator, Phase Control (German)	1
775 255EN	LIT: E2.4.2.2 Fault Simulator, Phase Control	1*

* additionally recommended

The experiments are carried out on training panels in panel frames.

Objectives

- Protective measures and electrical safety
- Finding and analysing faults in phase angle control circuits
- Use of commercial measuring instruments: hand-held multimeters and oscilloscopes

The fault simulator is a standard dimmer for a resistive load ($P = \text{max. } 1.2 \text{ kW}$) pre-calibrated for minimum value. Various measuring points allow for systematic troubleshooting. There are a total of 20 faults which can be switched and which are of the following categories:

- Breaks
- Short circuits
- Wrong components
- Component faults

The faults are activated by slider switches located behind a lockable cover.

The equipment set is designed for student experiments in a laboratory using low voltage (230 V AC). Experiment procedures are provided in a printed manual.

The target group is students in vocational colleges. The experiments are intended as an introduction at a simple level.

Topics

- Investigation of a circuit with some 20 different faults
- Component faults (short circuits, high resistance)
- Breaks in conductors
- High or low-resistance connections within the circuit
- Wrong or missing components (e.g. incorrect values)

Self-Commutated Converters

E2.4.3.1
Switchable Valves and
DC choppers

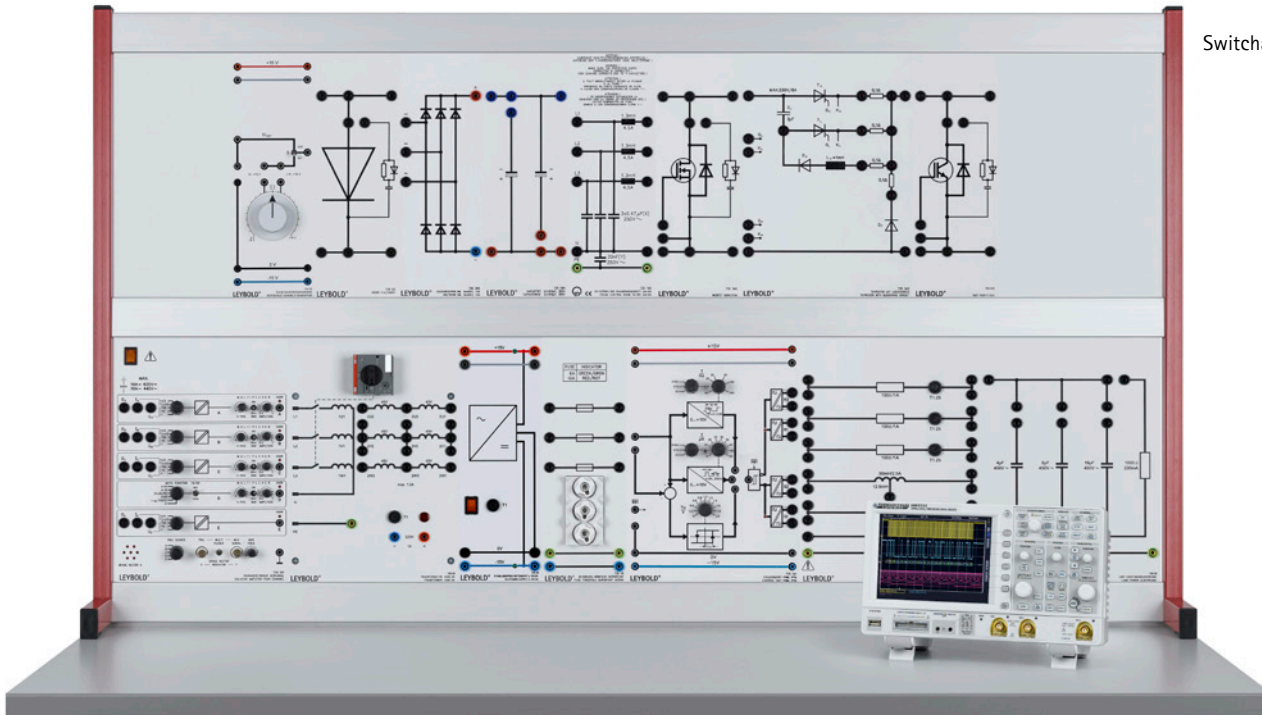

Switchable Valves and DC choppers (E2.4.3.1)

Cat. No.	Description	E2.4.3.1
734 02	Reference variable generator	1
735 02	Diode, 1000 V/10 A	1
735 09	Load for power electronics	1
735 18	Fuses, ultra-rapid set of 3	1
735 065	Rectifier B6, 3X400 V/10 A	1
735 095	Capacitors 2x 1000 µF, 385 V	1
735 190	Phase control noise filter 3 x 4.5 A	1
735 341	Control unit PWM; PFM	1
735 342	MOSFET 500 V/10 A	1
735 343	Thyristor with turn-off circuit 230 V/8 A	1
735 346	IGBT 1000 V/10 A	1
501 02	BNC cable, 1 m	2
531 282	Multimeter Metrahit Pro	2
575 231	Probe 100 MHz, 1:1 / 10:1	2
575 230	Digital storage oscilloscope 722	1
735 261	Isolation amplifier, four channel	1
726 09	Panel frame T130, two-level	1
726 86	Stabilised power supply ±15 V/3 A	1
726 80	Transformer, 45/90, 3 N	1
537 34	Rheostat, 100 ohms	1
537 35	Rheostat, 330 ohms	1
731 91	Shunt wound machine 0.3	1*
731 07	Shaft end guard 0.3	2*
500 59	Safety bridging plugs, black, set of 10	2
500 851	Safety connecting leads, 32 A, set of 32	1
500 852	Safety connecting leads, 32 A, yellow/green, set of 10	1
775 260DE	LIT: E2.4.3.1 Switchable Valves and DC Choppers (German)	1
775 260EN	LIT: E2.4.3.1 Switchable Valves and DC Choppers	1*

* additionally recommended

The experiments are carried out on training panels in panel frames.

Objectives

- Protective measures and electrical safety
- Circuit assembly and wiring according to circuit diagrams
- Use of commercial measuring instruments: hand-held multimeters and oscilloscopes

Static converter valves with gate turn-off can be used to assemble a variety of DC choppers (DC/DC converters). Three different control methods are used for this:

- Pulse width modulation
- Pulse sequence modulation
- Two position control

Topics

- Thyristor with quenching circuit
- Power MOSFETs
- Insulated gate bipolar transistors (IGBTs)
- On-state characteristics
- Off-state and switching properties
- Control of DC choppers
- Step-up and step-down converters
- DC choppers using a thyristor with quenching circuit, PWM
- Control characteristic for constant load current
- DC chopper using MOSFETs, PWM, PFM and two-position control
- Single-ended forward and push-pull converters
- Half-bridge and full-bridge forward converters
- DC choppers used for step-up conversion, PWM and two-position control
- Energy recovery operation with PWM
- Energy recovery operation with two-position control
- Characteristics with variable current setpoints
- DC choppers with IGBT used as inverting step-up/step-down controllers with PWM

Self-Commutated Converters

E2.4.3.2 Switched-Mode Power Supplies

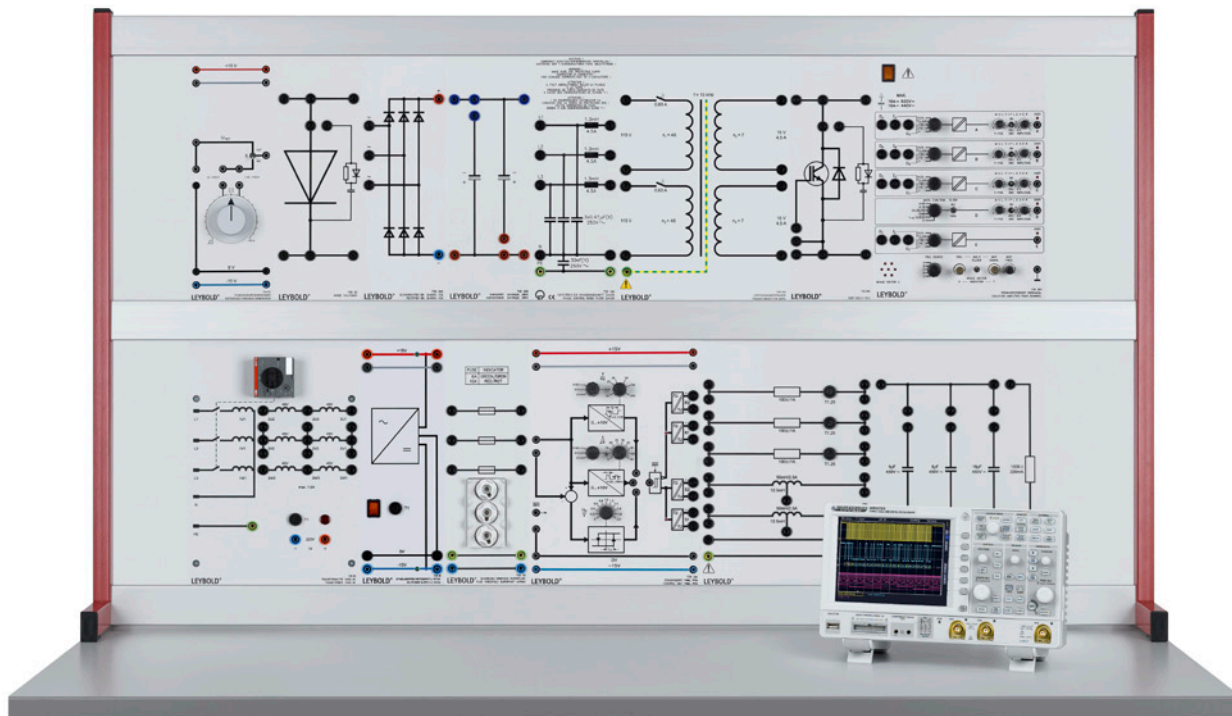

Switched-Mode Power Supplies (E2.4.3.2)

Cat. No.	Description	E2.4.3.2
734 02	Reference variable generator	1
735 02	Diode, 1000 V/10 A	4
735 09	Load for power electronics	1
735 18	Fuses, ultra-rapid set of 3	1
735 065	Rectifier B6, 3X400 V/10 A	1
735 095	Capacitors 2x 1000 µF, 385 V	1
735 105	Transformer for SMPS	1
735 190	Phase control noise filter 3 x 4.5 A	1
735 341	Control unit PWM; PFM	1
735 346	IGBT 1000 V/10 A	3
501 02	BNC cable, 1 m	2
531 282	Multimeter Metrahit Pro	2
575 231	Probe 100 MHz, 1:1 / 10:1	2
575 230	Digital storage oscilloscope 722	1
735 261	Isolation amplifier, four channel	1
726 09	Panel frame T130, two-level	1
726 86	Stabilised power supply ±15 V/3 A	1
726 80	Transformer, 45/90, 3 N	1
500 59	Safety bridging plugs, black, set of 10	2
500 851	Safety connecting leads, 32 A, set of 32	1
500 852	Safety connecting leads, 32 A, yellow/green, set of 10	1
775 265DE	LIT: E2.4.3.2 Switched-Mode Power Supplies (German)	1
775 265EN	LIT: E2.4.3.2 Switched-Mode Power Supplies	1*

* additionally recommended

The experiments are carried out on training panels in panel frames.

Objectives

- Protective measures and electrical safety
- Circuit assembly and wiring according to circuit diagrams
- Use of commercial measuring instruments: hand-held multimeters and oscilloscopes

Power electronics allows for power supplies to be built which are characterised by high efficiency and compact size. This is achieved using switching components and switching frequencies which are as high as possible. The following experiments on primary switched-mode power supplies can be set up and their properties investigated:

- Single-ended forward converters
- Push-pull converters
- Asymmetric half-bridge forward converters
- Full-bridge forward converters
- Flyback converters

The equipment set is suitable both for student experiments in a lab using low voltage (400 V three-phase) and on a mobile trolley for demonstrations by teachers in a classroom. The experiment procedures are contained in a printed manual.

Topics

- Step-down converters with various loads
- Control of average values for voltage and current using PWM
- How voltage and current change over time with a resistive load
- How voltage and current change over time with a resistive-inductive load
- Resistive-inductive load with freewheeling diode and smoothing capacitor
- Step-down converter with $V_1 = 110$ V, losses, efficiency
- Step-up/step-down converters
- Control of average values for voltage and current using PWM
- Measurement of voltage and current over time when $V_1 = 15$ V
- Measurement of voltage and current over time when $V_1 = 110$ V
- Measurement with intermittent choke current
- Step-up/step-down converters with power factor correction
- Effect of hysteresis
- Flyback converters
- Control of average values for voltage and current using PWM
- Measurement of voltage and current over time when $V_1 = 15$ V
- Effect of RCD protective circuitry
- Measurement of voltage and current over time when $V_1 = 110$ V

Self-Commutated Converters

E2.4.3.3
Inverters

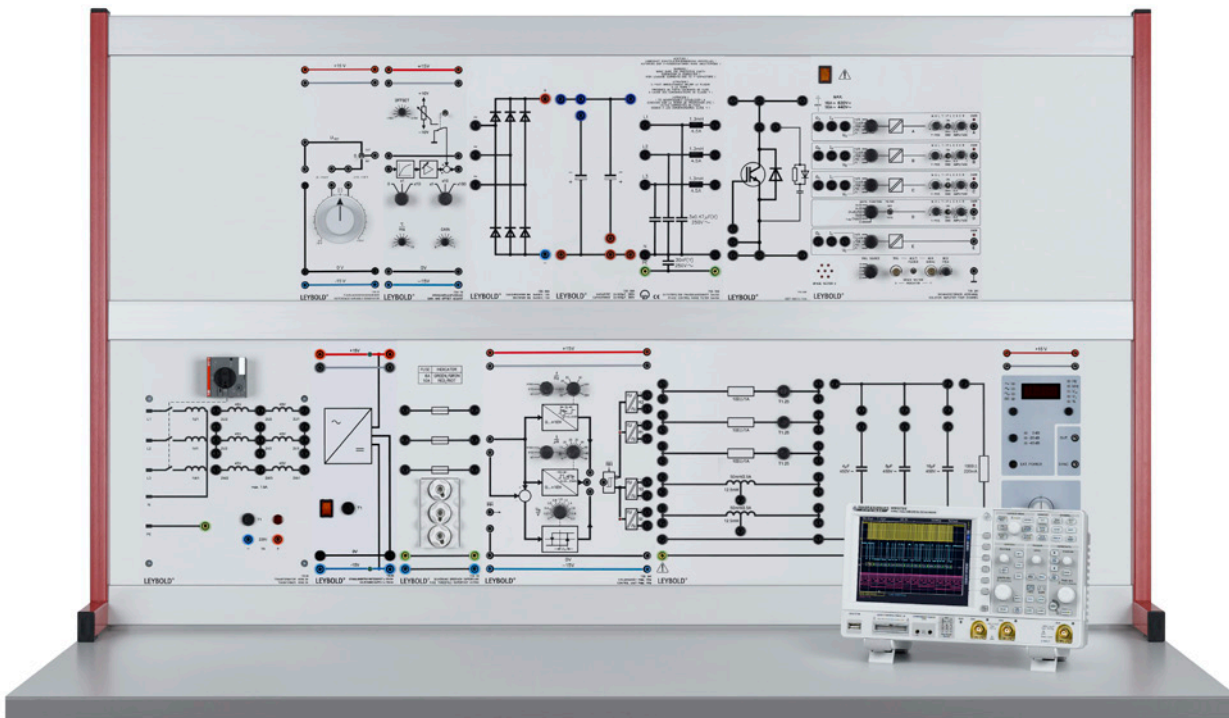

Inverters (E2.4.3.3)

Cat. No.	Description	E2.4.3.3
734 02	Reference variable generator	1
735 09	Load for power electronics	1
735 18	Fuses, ultra-rapid set of 3	1
726 962N	Function generator 200 kHz net	1
725 007	Software: Leylab.control Lite	1
734 19	Gain and offset adjust	1
735 065	Rectifier B6, 3X400 V/10 A	1
735 095	Capacitors 2x 1000 µF, 385 V	1
735 190	Phase control noise filter 3 x 4.5 A	1
735 341	Control unit PWM; PFM	1
735 346	IGBT 1000 V/10 A	4
501 02	BNC cable, 1 m	2
531 282	Multimeter Metrahit Pro	2
575 231	Probe 100 MHz, 1:1 / 10:1	2
575 230	Digital storage oscilloscope 722	1
735 261	Isolation amplifier, four channel	1
726 10	Panel frame T150, two-level	1
726 86	Stabilised power supply ±15 V/3 A	1
726 80	Transformer, 45/90, 3 N	1
500 59	Safety bridging plugs, black, set of 10	2
500 851	Safety connecting leads, 32 A, set of 32	1
500 852	Safety connecting leads, 32 A, yellow/green, set of 10	1
775 270DE	LIT: E2.4.3.3 Inverters (German)	1
775 270EN	LIT: E2.4.3.3 Inverters	1*

* additionally recommended

The experiments are carried out on training panels in panel frames.

Objectives

- Protective measures and electrical safety
- Circuit assembly and wiring according to circuit diagrams
- Use of commercial measuring instruments: hand-held multimeters and oscilloscopes

Self commutated inverters are used in frequency converters, uninterruptible power supplies, mains coupling equipment for photovoltaic systems etc. This equipment set makes it possible to construct a single-phase AC inverter to create an AC voltage of variable frequency and amplitude.

The equipment set is suitable both for student experiments in a lab using low voltage (400 V three-phase) and on a mobile trolley for demonstrations by teachers in a classroom. The experiment procedures are contained in a printed manual.

The target group is made up of commercial apprentices and students of electrical machine construction. The course offers experiments at an intermediate level and also allows for the necessary insight into machine behaviour for scientific interpretation at undergraduate level.

Topics

Single ended forward converters

- Control of average values for voltage and current using PWM
- Measurement of voltage and current over time when $V_1 = 30$
- Measurement of voltage and current over time when $V_1 = 115$
- Measurement of efficiency and voltage stability

Asymmetric half-bridge forward converter

- Control of average values for voltage and current using PWM
- Time characteristic when $v = 0.75$
- Time characteristic when $v = 0.50$
- Time characteristic with duty cycle switch-over
- Time characteristic for sinusoidal inverter
- Inverter with $V_1 = 115$ V
- Inverter with $V_1 = 115$ V, $f = 5$ kHz



E2 ELECTRICAL DRIVES

E2.5 DRIVE TECHNOLOGY

E2.5.1 COMPACT SYSTEMS FOR DRIVE TECHNOLOGY

E2.5.1.1 COM3LAB Multimedia: Machines & Drives

E2.5.1.2 Drive Control with Training Panels

E2.5.2 INDUSTRIAL DC DRIVES

E2.5.2.1 Static Converter Drive with DC Machines

E2.5.2.2 DC-Chopper Drive with DC Machines

E2.5.3 INDUSTRIAL 3-PHASE DRIVES

E2.5.3.1 Drives with Induction Machines

E2.5.3.2 Basics of Frequency Converters

E2.5.3.3 Drives with Educational Frequency Converter

E2.5.3.4 Drives with Industry Frequency Converter 0.3

E2.5.3.5 Drives with Industry Frequency Converter 1.0

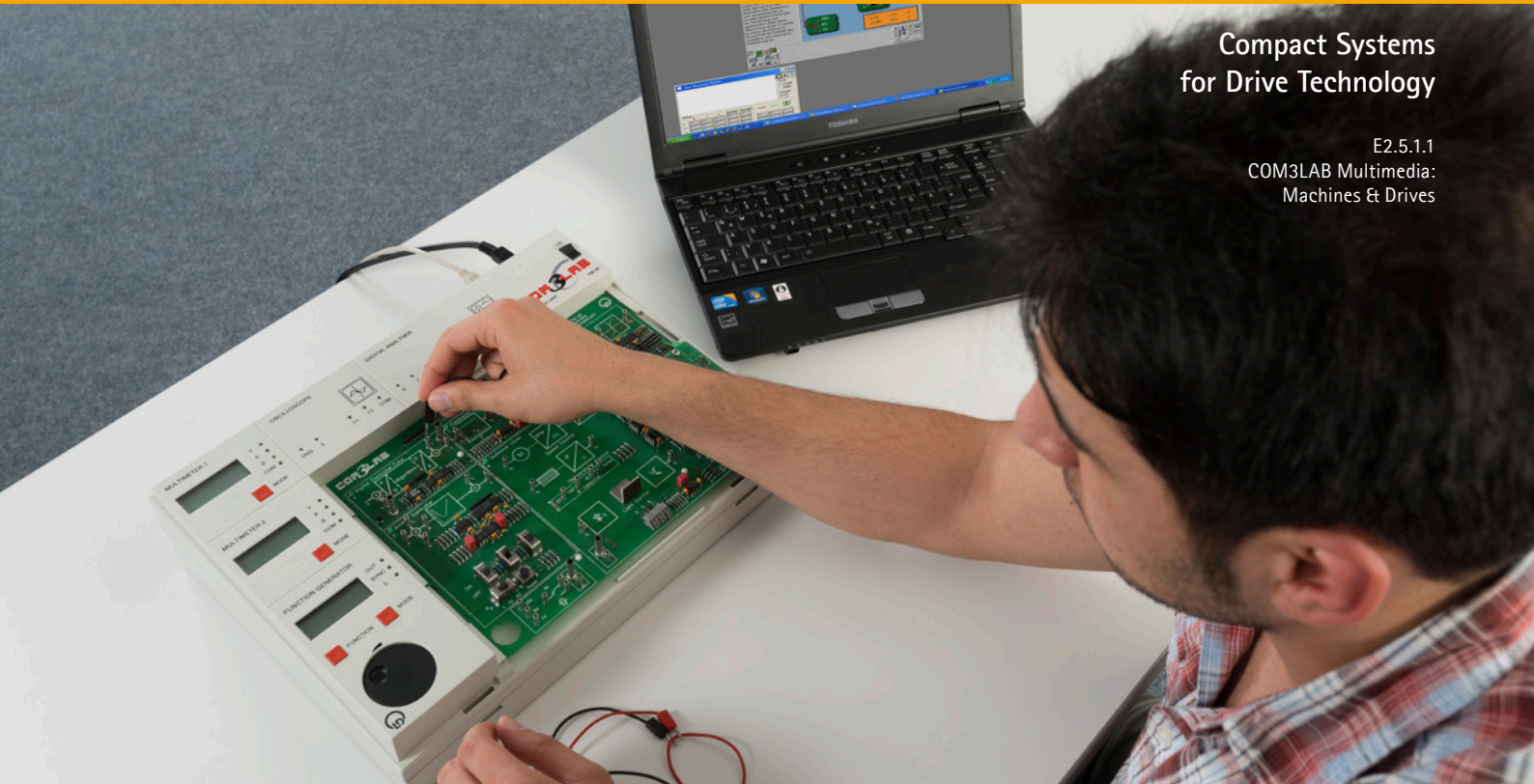

COM3LAB Multimedia: Machines & Drives (E2.5.1.1)

Cat. No.	Description	E2.5.1.1
700 25	COM3LAB course: Electrical machines I	1
700 82	COM3LAB course: Control technology I	1
700 00USB	COM3LAB master unit (USB)	1
700 00CBTEN	CD: COM3LAB software	1*
700 83	COM3LAB course: Control technology II	1*
731 91	Shunt wound machine 0.3	1*
731 09	Tacho generator 0.3	1*
731 06	Coupling 0.3	1*
731 07	Shaft end guard 0.3	1*
731 08	Coupling guard 0.3	1*
734 22	Actuator, 115...230 V/1 kW	1*
734 19	Gain and offset adjust	1*
726 86	Stabilised power supply ± 15 V/3 A	1*
500 851	Safety connecting leads, 32 A, set of 32	1*
500 852	Safety connecting leads, 32 A, yellow/green, set of 10	1*
500 59	Safety bridging plugs, black, set of 10	1*
726 19	Panel frame SL85, single-level	1*
775 190DE	LIT: E2.2.2.0 DC Machines 0.3 (German)	1*
775 190EN	LIT: E2.2.2.0 DC Machines 0.3	1

* additionally recommended

The experiments are carried out using the multimedia training system COM3LAB.

Objectives

- Recognising basic physical principles
- Recording machine characteristics
- Introduction to drive technology

The equipment set includes the COM3LAB courses, Electrical machines I and Closed-loop control. This allows important experiments to be conducted in the field of electrical drives. The operating response of electrical machines is investigated in terms of physics and mechanics and by means of speed-torque characteristics. The experiments explore how electrical machines are connected,

as well as reversal of direction and adjustment of speed, plus wiring of the terminal board. The closed-loop control course investigates the fundamentals of variable speed drives. The characteristic parameters for control loops are measured and the design of closed control loops is shown experimentally.

Features

- Compact, highly integrated machine course
- Integrated machine test system
- Extensive charting of technical control loops using DDC controllers

The speed control of a commercially available shunt-wound machine rated at 300 W is investigated as part of a project lesson. It is necessary to use the digital controller from the COM3LAB course, Closed-loop control II, in order to configure and optimise this for the industrial motor.

Topics

- Lorentz force
- Commutator machines
- Series-wound and shunt-wound machines
- Separately excited DC machines
- Adjustment of speed
- Reversal of rotation
- Terminal boards
- Three-phase machines
- Synchronous machines
- Starting response
- Measurement of speed using a stroboscope
- Asynchronous (induction) machines
- Three-phase drives
- V/f mode
- Characteristics, determination of breakdown torque
- Thermal effects
- Measurement of slip
- Stepper motors
- Half- and full-step operation
- PID controllers
- Step responses
- Control errors

Compact Systems for Drive Technology

E2.5.1.2 Drive Control with Training Panels

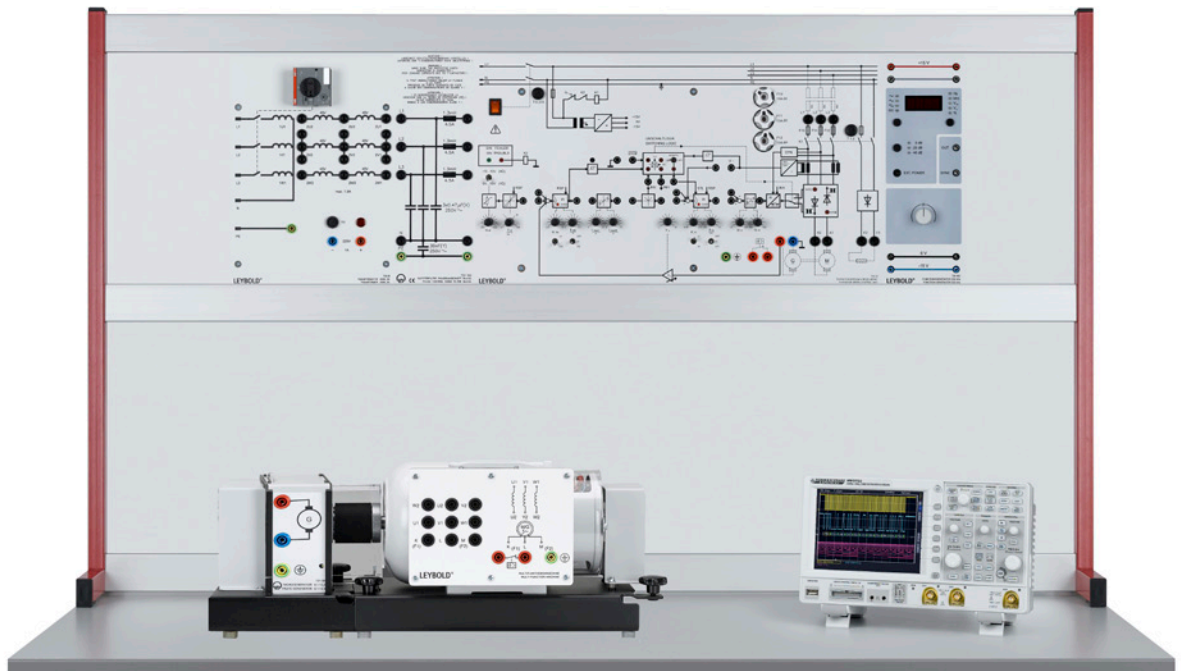

Drive Control with Training Panels (E2.5.1.2)

Cat. No.	Description	E2.5.1.2
734 02	Reference variable generator	1
734 064N	PID digital controller Net	1
725 007	Software: Leylab.control Lite	1
734 111	Set of machines 10 W	1
524 016S2	Profi-CASSY Starter 2	1
726 09	Panel frame T130, two-level	1
726 86	Stabilised power supply ± 15 V/3 A	1
500 59	Safety bridging plugs, black, set of 10	1
500 592	Safety bridging plugs with tap, black, set of 10	1
501 532	Connecting leads, 19 A, set of 30	1
734 481	WinFACT COM3LAB/CASSY edition, german	1
575 685DE	LIT: Drive Control (German)	1
575 685EN	LIT: Drive Control	1*

* additionally recommended

The experiments are carried out using training panels in panel frames.

Objectives

- Experiment set-up and wiring according to circuit diagrams
- How to handle closed-loop control systems
- Use of computer-controlled measuring interfaces
- Integration of block-oriented software in practical applications of closed-loop control

The equipment set is mainly concerned with the closed-loop control aspects of electrical drives. In addition, various machine characteristics are measured. The main training system is the 10 W machine set, which makes up a coupled motor-generator system. An integrated electronic load can be connected to the generator. This allows the effects of load fluctuations to be checked.

Features

- Compact machine set with integrated power amplifier
- Integrated electronic load with visual display of power which has been converted into heat
- Integrated measuring instruments for speed and torque
- Pre-filter which can be activated/deactivated to change the systems's order

The equipment set incorporates student experiments which can be carried out in a laboratory safely using safety extra-low voltage. Experiment instructions are contained in a manual in either printed or digital form.

The target group is made up of commercial apprentices and students of power engineering. The course offers experiments at an intermediate level for vocational colleges and undergraduate level.

Topics

- Speed-torque characteristic
- Characteristic for generator voltage
- Step response of motors
- Load-dependent step responses
- Automatic speed control using digital controllers
- Closed-loop control of generator voltage
- Steady-state control deviation using P-control
- Aperiodic and oscillating control response
- Determination of optimum operating point
- Control errors due to limiting of manipulated variable
- Effects of dead-time and saturation
- Automatic speed control using software controller
- Setpoint control
- Disturbance control

The PID digital controller Net (734 064N) can be incorporated into a network. The basic software *LEYLAB.control Lite* or the full version *LEYLAB.control* (725 006) is needed to operate the equipment. An optional non-networkable version is also available.

Industrial DC Drives

E2.5.2.1
Static Converter Drive
with DC Machines

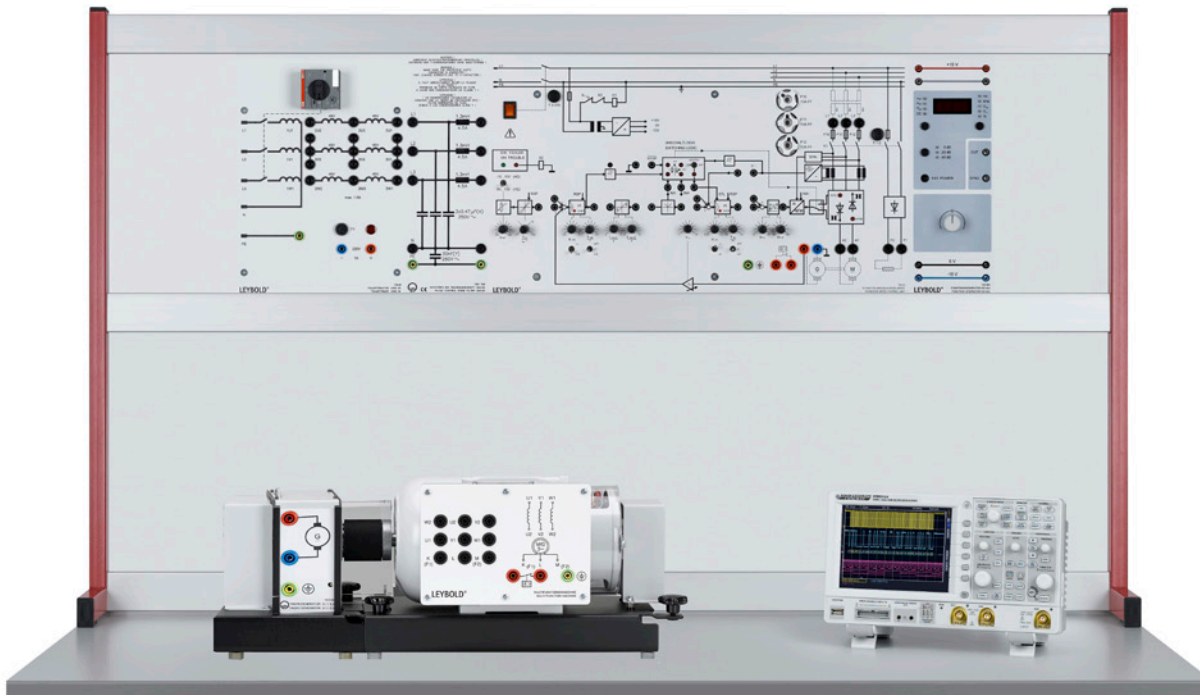

Static Converter Drive with DC Machines (E2.5.2.1)

Cat. No.	Description	E2.5.2.1
735 32	Thyristor speed control unit	1
731 09	Tacho generator 0.3	1
731 86	DC compound machine 0.3	1
735 190	Phase control noise filter 3 x 4.5 A	1
531 282	Multimeter Metrahit Pro	2*
575 231	Probe 100 MHz, 1:1 / 10:1	2
575 230	Digital storage oscilloscope 722	1
726 09	Panel frame T130, two-level	1
726 80	Transformer, 45/90, 3 N	1
726 962N	Function generator 200 kHz net	1
562 791	Plug-in power supply, 12 V AC	1
725 007	Software: Leylab.control Lite	1
731 06	Coupling 0.3	1
731 07	Shaft end guard 0.3	2
731 08	Coupling guard 0.3	1
500 59	Safety bridging plugs, black, set of 10	1
500 851	Safety connecting leads, 32 A, set of 32	1
500 852	Safety connecting leads, 32 A, yellow/green, set of 10	1
775 280DE	LIT: E2.5.2.1 Static Converter Drive with DC Machines (German)	1
775 280EN	LIT: E2.5.2.1 Static Converter Drive with DC Machines	1*

* additionally recommended

Traditionally, DC machines were used for variable speed drives. By adjusting the armature voltage or by armature field weakening, the speed can be altered and by changing the polarity of the armature or the excitation voltage, it is possible to reverse the direction of rotation. Whereas in times past electro-mechanical components were used for this, such as starters, field regulators or pole change-over switches, nowadays such things are handled almost exclusively by static converters. Converter-fed DC drives are a popular form of controlled electrical drives. The reasons for their popularity are the reliable, tough and inexpensive speed controllers and the excellent control dynamics of the overall system.

The experiments are carried out using DC machines of industrial manufacture. The power is supplied to the machine under test via a thyristor speed controller.

Objectives

- Protective measures and electrical safety
- Setting up variable speed DC drives and putting them into operation
- Assessment of control response

The equipment set is suitable both for student experiments in a lab using low voltage (400 V three-phase) and on a mobile trolley for demonstrations by teachers in a classroom. The experiment procedures are contained in a printed manual.

Topics

- Automatic control of multi-quadrant drive
- Introduction to the requirements
- Analysis of controlled systems
- Analysis of actuating static converters
- Optimisation of the current control loop
- Recording of armature circuit constants
- Adaptation of current controller
- Adjustment of current limiting
- Optimisation of speed control loop
- Putting thyristor speed control in the first quadrant into operation
- Setting of DC chopper and inverter stability limits
- Recording of static converter control characteristic
- Determination of armature circuit constants
- Recording of the transient function of the controlled variable, armature current
- Recording of the transient function of the controlled variable, armature current, with and without adaptive controller
- Switchover of static converters
- Setting current limiting
- Determination of the integral-action coefficient for the drive
- Determination of the transient of the controlled variable, speed
- Recording a switching diagram

The Function generator 200 kHz Net (726 962N) can be incorporated into a network. The basic software *LEYLAB.control Lite* (725 007) or the full version *LEYLAB.control* (725 006) is needed to operate the equipment. An optional non-networkable version is also available.

Industrial DC Drives

E2.5.2.2 DC-Chopper Drive with DC Machines

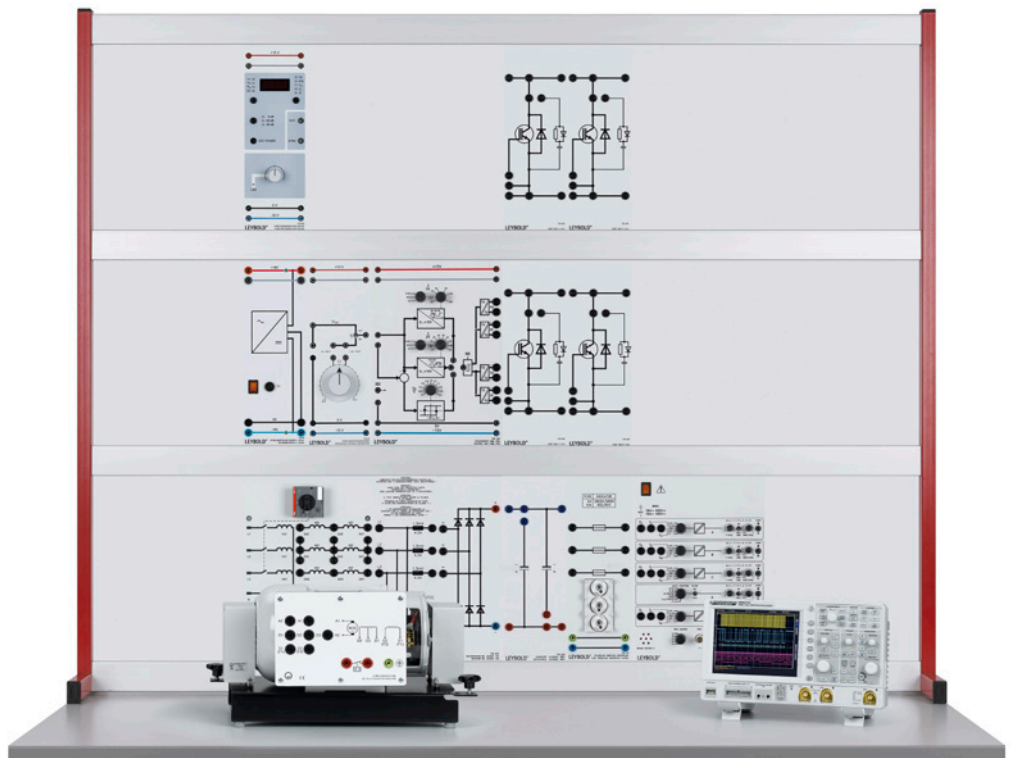

DC-Chopper Drive with DC Machines (E2.5.2.2)

Cat. No.	Description	E2.5.2.2
731 86	DC compound machine 0.3	1
726 80	Transformer, 45/90, 3 N	1
734 02	Reference variable generator	1
726 86	Stabilised power supply ± 15 V/3 A	1
726 962N	Function generator 200 kHz net	1
725 007	Software: Leylab.control Lite	1
735 341	Control unit PWM; PFM	1
735 346	IGBT 1000 V/10 A	4
735 02	Diode, 1000 V/10 A	1
735 065	Rectifier B6, 3X400 V/10 A	1
735 095	Capacitors 2x 1000 μ F, 385 V	1
735 18	Fuses, ultra-rapid set of 3	1
735 190	Phase control noise filter 3 x 4.5 A	1
531 282	Multimeter Metrahit Pro	2
575 231	Probe 100 MHz, 1:1 / 10:1	2
575 230	Digital storage oscilloscope 722	1
731 07	Shaft end guard 0.3	2
501 02	BNC cable, 1 m	2
735 261	Isolation amplifier, four channel	1
500 851	Safety connecting leads, 32 A, set of 32	1
500 852	Safety connecting leads, 32 A, yellow/green, set of 10	1
500 59	Safety bridging plugs, black, set of 10	3
775 280DE	LIT: E2.5.2.1 Static Converter Drive with DC Machines (German)	1
775 280EN	LIT: E2.5.2.1 Static Converter Drive with DC Machines	1*

* additionally recommended

The experiments are carried out using training panels in panel frames along with a DC machine of industrial design.

Objectives

- Protective measures and electrical safety
- Experiment set-up and wiring according to a circuit diagram
- Setting up industrial commutator machines and putting them into operation
- Use of computer-assisted measurement interfaces

This equipment set allows you to set up a modern drive system in order to adjust the speed. The power electronics is implemented in the form of circuits using modular, discrete components. The load used is a DC machine operating without a load. The chopper allows for the speed to be set by limiting trigger angle and for the direction of rotation to be reversed. The trigger response of thyristors to pulse and burst control is investigated along with the resulting effects on the effects on the running characteristics of the machine.

The equipment set is suitable both for student experiments in a lab using low voltage (400 V three-phase) and on a mobile trolley for demonstrations by teachers in a classroom. The experiment procedures are contained in a printed manual.

The target group is made up of commercial apprentices and students of electrical machine construction. The course offers experiments at an intermediate level and also allows for the necessary insight into machine behaviour for scientific interpretation at undergraduate level.

Topics

- Set-up of an H-bridge
- Full-bridge converter
- Reversal of voltage
- Reversal of current
- Setting the speed for DC machines

The Function generator 200 kHz Net (726 962N) can be incorporated into a network. The basic software *LEYLAB.control Lite* (725 007) or the full version *LEYLAB.control* (725 006) is needed to operate the equipment. An optional non-networkable version is also available.

Industrial 3-Phase Drives

E2.5.3.1
Drives with
Induction Machines

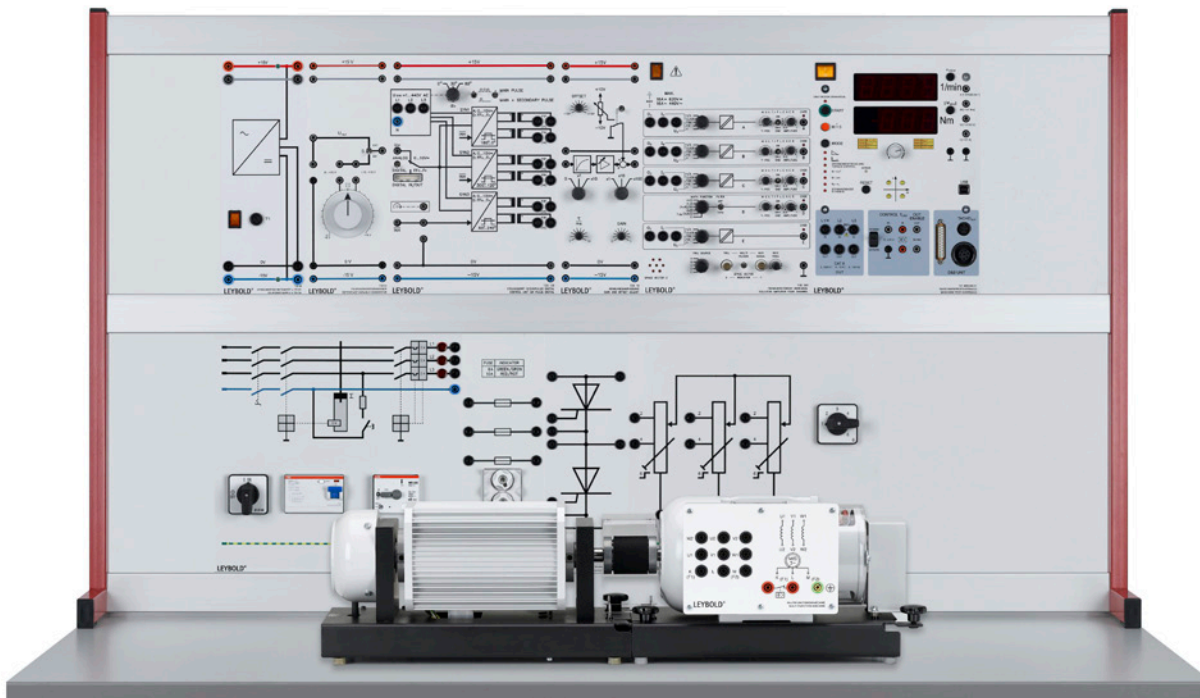

Drives with Induction Machines (E2.5.3.1)

Cat. No.	Description	E2.5.3.1
734 02	Reference variable generator	1
734 19	Gain and offset adjust	1
735 07	Thyristor branch pair, 1000 V/12 A	3
735 09	Load for power electronics	1
735 17	Run-up control unit	1
735 18	Fuses, ultra-rapid set of 3	2
735 20	Trigger point limiter	1
734 064N	PID digital controller Net	1
725 007	Software: Leylab.control Lite	1
735 065	Rectifier B6, 3X400 V/10 A	1
735 135	Control unit six pulse, digital	1
735 190	Phase control noise filter 3 x 4.5 A	1
735 341	Control unit PWM; PFM	1
735 346	IGBT 1000 V/10 A	1
732 28	Multi-function machine 0.3	1
731 09	Tacho generator 0.3	1
732 29	Rotor starter 0.3	1
531 282	Multimeter Metrahit Pro	2
727 11	Power meter	1
575 231	Probe 100 MHz, 1:1 / 10:1	2
575 230	Digital storage oscilloscope 722	1
735 261	Isolation amplifier, four channel	1
501 02	BNC cable, 1 m	2
731 989USB	Machine test system 0.3	1
728 421	CBM10 MOMO/FCCP	1
726 09	Panel frame T130, two-level	1
726 86	Stabilised power supply ± 15 V/3 A	1
726 75	Three-phase supply unit with ELCB	1
726 80	Transformer, 45/90, 3 N	1
731 06	Coupling 0.3	2
731 07	Shaft end guard 0.3	2
731 081	Coupling guard 0.3 transparent	2
500 59	Safety bridging plugs, black, set of 10	2

Cat. No.	Description	E2.5.3.1
500 851	Safety connecting leads, 32 A, set of 32	1
500 852	Safety connecting leads, 32 A, yellow/green, set of 10	1
775 285DE	LIT: E2.5.3.1 Drives with Induction Machines (German)	1
775 285EN	LIT: E2.5.3.1 Drives with Induction Machines	1*
	The PID digital controller Net (734 064N) can be incorporated into a network. The basic software <i>LEYLAB.control Lite</i> or the full version <i>LEYLAB.control</i> (725 006) is needed to operate the equipment. An optional non-networkable version is also available.	1

* additionally recommended

The power electronics part of this lab practical uses training panels. The electrical machine employed is an industrial machine on a base, whereby the characteristics of the machine can be determined using the Machine test system 0.3. Power is supplied to the machine under test via a static converter, which obtains its power from the (three-phase) mains network.

Objectives

- Protective measures and electrical safety
- Set-up of power generating systems according to circuit diagrams
- Putting electrical drives into operation
- Recording of load characteristics with various operating parameters
- Achieving skills in measuring electrical machines
- Automatic speed control for an asynchronous (induction) machine

This equipment set allows experiments on how the speed of asynchronous (induction) machines can be modified using line-commutated static converters. The speed of the machine depends on the stator voltage and rotor impedance and can be adjusted in the experiment by changing these two variables. As well as putting the machine into operation and setting its parameters, the main thing considered is the change in the response of the machine. This involves recording load characteristics and determining key parameters. Addition of a PID controller allows the experiment set-ups to be enhanced into variable-speed drives with closed-loop speed control.

Students work in the power engineering lab with mains voltage. Experiments procedures are contained in a printed manual. The experiments are designed for intermediate and advanced levels.

Topics

- Drives using motors with slip-ring rotors and three-phase power controllers
- Drives using motors with slip-ring rotors and pulse-controlled rotor impedance
- Drives using motors with slip-ring rotors and static converter cascades

Industrial 3-Phase Drives

E2.5.3.2 Basics of Frequency Converters



Basics of Frequency Converters (E2.5.3.2)

Cat. No.	Description	E2.5.3.2
735 297	Universal converter 3 x 230 V	1
735 09	Load for power electronics	1
735 296	Converter input/output	1
501 02	BNC cable, 1 m	2
531 282	Multimeter Metrahit Pro	1
575 231	Probe 100 MHz, 1:1 / 10:1	2
575 230	Digital storage oscilloscope 722	1
735 261	Isolation amplifier, four channel	1
726 09	Panel frame T130, two-level	1
726 71	Single-phase supply unit	1
500 59	Safety bridging plugs, black, set of 10	1
500 851	Safety connecting leads, 32 A, set of 32	1
500 852	Safety connecting leads, 32 A, yellow/green, set of 10	1
775 286DE	LIT: E2.5.3.2 Basics of Frequency Converters (German)	1
775 286EN	LIT: E2.5.3.2 Basics of Frequency Converters	1*

* additionally recommended

This laboratory practical utilises training panels in panel frames. The power is supplied to the frequency converter directly from the mains (mains voltage, 230 V).

Objectives

- Protective measures and electrical safety
- Components of a frequency converter with variable voltage link
- Setting parameters for frequency converters
- Gaining skill in measurement techniques

This equipment set offers an insight into the circuitry of frequency converters with variable voltage link. Measurements are made on the components of a frequency converter especially designed for educational purposes. The experiments use a static electronic load, which facilitates the evaluation of current

and voltage curves. A rotating field with variable frequency is also investigated. The following components can be accessed:

- Input bridge rectifier with link capacitor
- Brake chopper
- Power inverter

Students work in the power engineering lab with mains voltage. Experiments procedures are contained in a printed manual. The experiments are designed for intermediate and advanced levels.

Topics

- Rotating field and space vectors
- Feeding a sinusoidal signal from the normal three-phase mains network
- Representation of space vectors
- Generation of a rotating field from a DC voltage
- Putting a converter into operation
- Fault-free activation of the mains voltage
- Activation of the input rectifier
- Switching off the converter
- Discharging the buffer capacitor
- Investigation of input rectifier
- Response with zero-delay angle setting, $CI = 00$
- Control characteristic
- Loading
- Control via external control voltage
- Investigation of output inverter
- Control of individual power transistors
- Generation of rotating field
- Loading with resistive load

Industrial 3-Phase Drives

E2.5.3.3
Drives with
Educational
Frequency
Converter

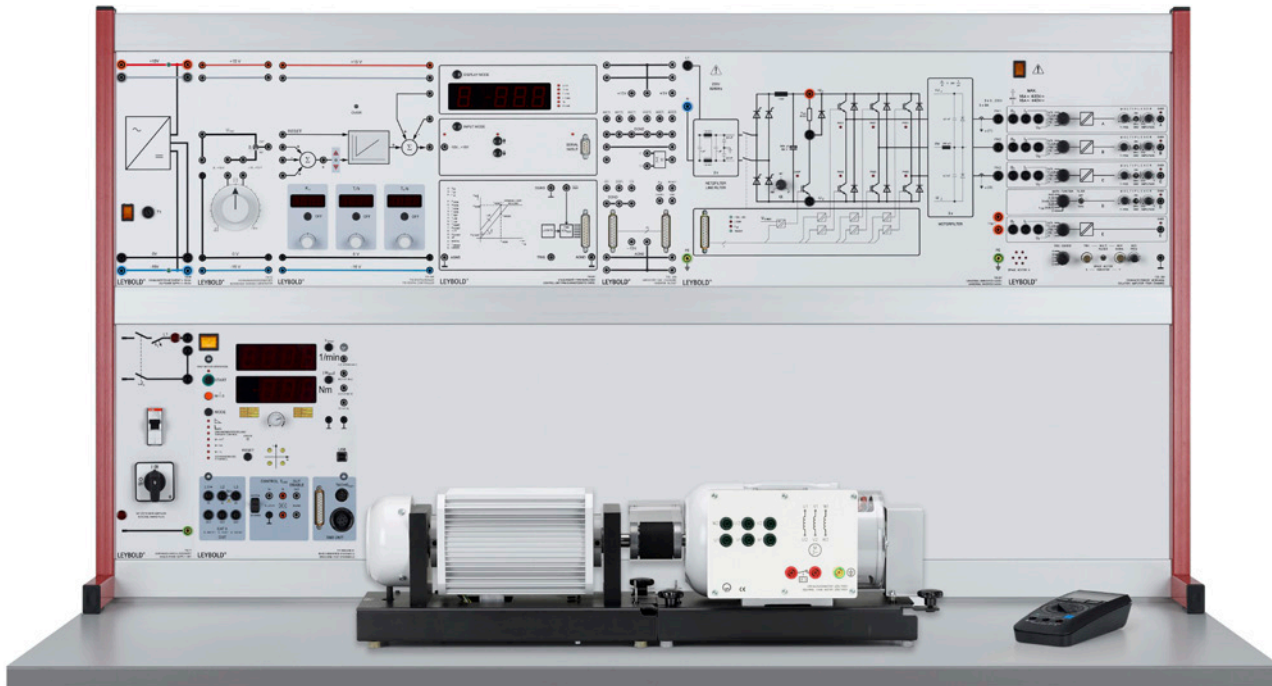

Drives with Educational Frequency Converter (E2.5.3.3)

Cat. No.	Description	E2.5.3.3
735 297	Universal converter 3 x 230 V	1
735 296	Converter input/output	1
731 09	Tacho generator 0.3	1*
732 104	Squirrel cage motor 230/400/0.3	1
734 02	Reference variable generator	1*
734 19	Gain and offset adjust	1*
734 064N	PID digital controller Net	1*
725 007	Software: Leylab.control Lite	1*
734 064	PID digital controller	1*
735 291	Control unit PWM	1
501 02	BNC cable, 1 m	2
531 282	Multimeter Metrahit Pro	1
575 231	Probe 100 MHz, 1:1 / 10:1	2
575 230	Digital storage oscilloscope 722	1
735 261	Isolation amplifier, four channel	1
731 989USB	Machine test system 0.3	1
728 421	CBM10 MOMO/FCCP	1
524 004	Adapter, USB port/serial port	1
729 769	RS-232 cable, 9-pole	1
726 09	Panel frame T130, two-level	1
726 86	Stabilised power supply ± 15 V/3 A	1
726 71	Single-phase supply unit	1
731 06	Coupling 0.3	1
731 07	Shaft end guard 0.3	1
731 081	Coupling guard 0.3 transparent	1
500 59	Safety bridging plugs, black, set of 10	1
500 851	Safety connecting leads, 32 A, set of 32	1
500 852	Safety connecting leads, 32 A, yellow/green, set of 10	1
775 300DE	LIT: E2.5.3.3 Drives with Educational Frequency Converter (German)	1
775 300EN	LIT: E2.5.3.3 Drives with Educational Frequency Converter	1*

* additionally recommended

The power electronics part of this lab practical uses training panels. The electrical machine employed is an industrial machine on a base, whereby the characteristics of the machine can be determined using the Machine test system 0.3. Power is supplied to the machine under test via an educationally designed frequency converter, which obtains its power from the normal mains (mains voltage, 230 V).

Objectives

- Protective measures and electrical safety
- Set-up of power generating systems according to circuit diagrams
- Putting electrical drives into operation
- Recording of load characteristics with various operating parameters
- Achieving skills in measuring electrical machines
- Automatic speed control for an asynchronous (induction) machine

Power electronics has developed from the technology of static converters to become one of the most important and all-encompassing areas of electrical engineering. The job of power electronics is to switch, control and convert electrical energy using power semiconductors with the best possible efficiency. One key application is drive technology. With the help of modern power electronics, it is possible to construct variable speed drives in DC and three-phase circuits for 4-quadrant operation. In this equipment set, a universal converter is used for open- and closed-loop control of speed for a squirrel cage motor.

Students work in the power engineering lab with mains voltage. Experiments procedures are contained in a printed manual. The experiments are designed for intermediate and advanced levels.

Topics

- Rotating field and space vectors
- Modulation types: square, trapezoidal, sinusoidal, pulse width modulation (PWM)
- Voltage vector control VVC
- Magnetisation with a linear V/f characteristic
- Boosting of magnetisation by means of the start voltage
- Optimisation of load characteristics by means of IxR compensation
- Slip compensation
- Operation of the motor in a star configuration
- Computer-assisted measurement and evaluation using CBM 10 software
- Recording a load characteristic
- Comparison of multiple load characteristics
- Brake choppers
- Variable-speed drives

Industrial 3-Phase Drives

E2.5.3.4 Drives with Industrial Frequency Converter 0.3



Drives with Industrial Frequency Converter 0.3 (E2.5.3.4)

Similar to illustration

Cat. No.	Description	E2.5.3.4
735 312	Industrial frequency converter 0.3	1
732 104	Squirrel cage motor 230/400/0.3	1
531 282	Multimeter Metrahit Pro	1
731 989USB	Machine test system 0.3	1
728 421	CBM10 MOMO/FCCP	1
735 314	LCP2 local control panel	1
726 10	Panel frame T150, two-level	1
731 06	Coupling 0.3	1
731 07	Shaft end guard 0.3	1
731 081	Coupling guard 0.3 transparent	1
500 59	Safety bridging plugs, black, set of 10	1
500 592	Safety bridging plugs with tap, black, set of 10	1*
500 591	Safety bridging plugs, yellow/green, set of 10	1
500 852	Safety connecting leads, 32 A, yellow/green, set of 10	1
500 851	Safety connecting leads, 32 A, set of 32	1
775 290DE	LIT: E2.5.3.4 Drives with Industry Frequency Converter 0.3 (German)	1
775 290EN	LIT: E2.5.3.4 Drives with Industry Frequency Converter 0.3	1*

* additionally recommended

The power electronics part of this lab practical uses training panels. The electrical machine employed is an industrial machine on a base, whereby the characteristics of the machine can be determined using the Machine test system 0.3. Power is supplied to the machine under test via an industrial frequency converter, which obtains its power from the normal mains power supply (mains voltage, 230 V).

Objectives

- Protective measures and electrical safety
- Set-up of power generating systems according to circuit diagrams
- Putting electrical drives into operation

- Recording of load characteristics with various operating parameters
- Achieving skills in measuring electrical machines
- Automatic speed control for an asynchronous (induction) machine

Using switchable converter valves, it is possible to set-up three-phase networks with variable frequency and amplitude. The speed of asynchronous (induction) machines is then variable with practically no losses over a broad range. In this lab, machines in the power class 0.3 kW are used. The equipment set includes an industrial compact converter. The experiments focus on putting converters into operation, setting their parameters and investigating machine response.

Students work in the power engineering lab with mains voltage. Experiments procedures are contained in a printed manual. The experiments are designed for intermediate and advanced levels.

Topics

- Fundamentals of three-phase machines
- Equivalent circuit for an asynchronous (induction) motor
- Torque, efficiency and optimum magnetisation
- Circuit wiring and connection of components
- Setting up a drive and testing its operation
- Parameter setting for a frequency converter
- Learning the key menus
- Measurement of converter output voltage
- Effect of start voltage
- Effect of start compensation (IxR compensation)
- Response of the machine in the absence of starting voltage and compensation
- Effect of slip compensation
- Recording of V/f characteristic for a machine operating without a load, with and without compensation of the frequency converter

Industrial 3-Phase Drives

E2.5.3.5
Drives with Industrial
Frequency Converter 1.0



Drives with Industrial Frequency Converter 1.0 (E2.5.3.5)

Cat. No.	Description	E2.5.3.5
735 3101	Industrial frequency converter 400 V	1
732 81	Squirrel cage motor 400/690 1.0	1
531 282	Multimeter Metrahit Pro	1
732 689USB	Machine test system 1.0	1
728 421	CBM10 MOMO/FCCP	1
726 10	Panel frame T150, two-level	1
732 56	Coupling 1.0	1
732 57	Shaft end guard 1.0	1
732 58	Coupling guard 1.0	1
500 592	Safety bridging plugs with tap, black, set of 10	1*
500 59	Safety bridging plugs, black, set of 10	1
500 591	Safety bridging plugs, yellow/green, set of 10	1
500 851	Safety connecting leads, 32 A, set of 32	1
500 852	Safety connecting leads, 32 A, yellow/green, set of 10	1
775 295DE	LIT: E2.5.3.5 Drives with Industry Frequency Converter 1.0 (German)	1
775 295EN	LIT: E2.5.3.5 Drives with Industry Frequency Converter 1.0	1*

* additionally recommended

The power electronics part of this lab practical uses training panels. The electrical machine employed is an industrial machine on a base, whereby the characteristics of the machine can be determined using the Machine test system 1.0. Power is supplied to the machine under test via an industrial frequency converter, which obtains its power from the normal (three-phase) mains.

Objectives

- Protective measures and electrical safety
- Set-up of power generating systems according to circuit diagrams
- Putting electrical drives into operation

- Recording of load characteristics with various operating parameters
- Achieving skills in measuring electrical machines
- Automatic speed control for an asynchronous (induction) machine

Using switchable converter valves, it is possible to set-up three-phase networks with variable frequency and amplitude. The speed of asynchronous (induction) machines is then variable with practically no losses over a broad range. Motors in the 1.0 kW rating class are used in this practical. The equipment set includes an industrial compact converter. The experiments focus on putting converters into operation, setting their parameters and investigating machine response.

Students work in the power engineering lab with mains voltage. Experiments procedures are contained in a printed manual.

The experiments are designed for intermediate and advanced levels.

Topics

- Fundamentals of three-phase machines
- Equivalent circuit for an asynchronous (induction) motor
- Torque, efficiency and optimum magnetisation
- Circuit wiring and connection of components
- Setting up a drive and testing its operation
- Parameter setting for a frequency converter
- Learning the key menus
- Measurement of converter output voltage
- Effect of start voltage
- Effect of start compensation (IxR compensation)
- Response of the machine in the absence of starting voltage and compensation
- Effect of slip compensation
- Recording of V/f characteristic for a machine operating without a load, with and without compensation of the frequency converter



E2 ELECTRICAL DRIVES

E2.6 SERVO TECHNOLOGY

E2.6.1 EDUCATIONALLY DESIGNED SERVOS

- E2.6.1.1 Basics of Servo Technology
- E2.6.1.2 DC Servo
- E2.6.1.3 AC Servo
- E2.6.1.4 Stepper Motor

E2.6.2 INDUSTRIAL SERVOS 300 W

- E2.6.2.1 AC Servo with Block Commutation
- E2.6.2.2 AC Servo with Sine Commutation
- E2.6.2.3 Position Servo Control

Educationally Designed Servos

E2.6.1.1
Basics of
Servo Technology

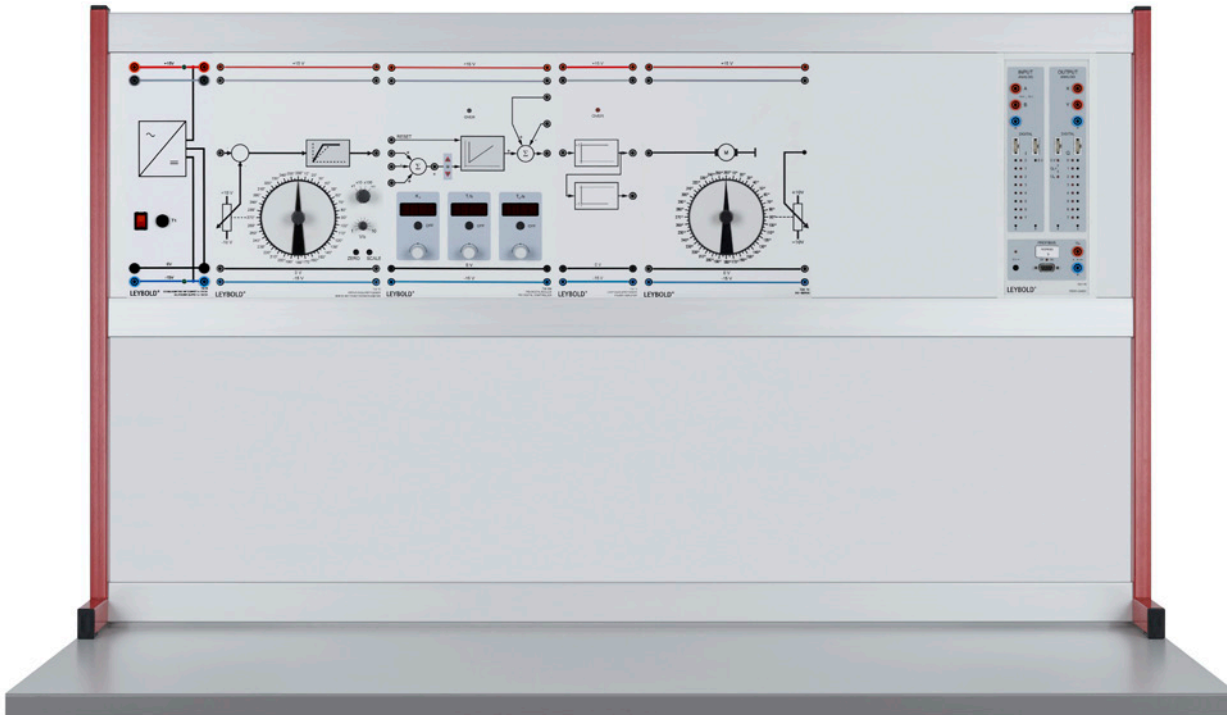

Basics of Servo Technology (E2.6.1.1)

Cat. No.	Description	E2.6.1.1
579 13	Toggle switch, STE 2/19	1
734 10	Servo setpoint generator	1
734 13	Power amplifier	1
734 14	DC servo	1
734 064N	PID digital controller Net	1
725 007	Software: Leylab.control Lite	1
524 016S2	Profi-CASSY Starter 2	1
726 09	Panel frame T130, two-level	1
726 86	Stabilised power supply ± 15 V/3 A	1
500 59	Safety bridging plugs, black, set of 10	1
500 851	Safety connecting leads, 32 A, set of 32	1
775 320DE	LIT: E2.6.1.1 Basics of Servo technology (German)	1
775 320EN	LIT: E2.6.1.1 Basics of Servo Technology	1*

* additionally recommended

Servos are drives used for open- and closed-loop control of position, speed or torque. In manufacturing, servos are often used as auxiliary drives for positioning items being worked on by machines. Servos are used in that sphere in CNC machines or robots. The requirements for servos demand high accuracy, dynamic properties and resilience to overloading.

The experiments are carried using training panels in panel frames.

Objectives

- Experiment set-up and wiring according to circuit diagrams
- Working with closed-loop control systems
- Optimisation of servo systems
- Use of computer-controlled measuring interfaces

The equipment set incorporates student experiments which can be carried out in a laboratory safely using safety extra-low voltage. Experiment instructions are contained in a manual in either printed or digital form.

The target group is made up of commercial apprentices and students of power engineering and mechatronics. The course offers introductory experiments at an intermediate level for vocational schools and colleges.

Topics

- Operation with a P-controller : determination of system deviation (error signals) or oscillation
- Operation with a PI-controller : elimination of system deviation (error signals), overshoot and tracking error
- Operation with a PID-controller : optimisation of system deviation (error signals) and oscillation

The Function generator 200 kHz Net (726 962N) can be incorporated into a network. The basic software *LEYLAB.control Lite* (725 007) or the full version *LEYLAB.control* (725 006) is needed to operate the equipment. An optional non-networkable version is also available.

Educationally Designed Servos

E2.6.1.2 DC Servo

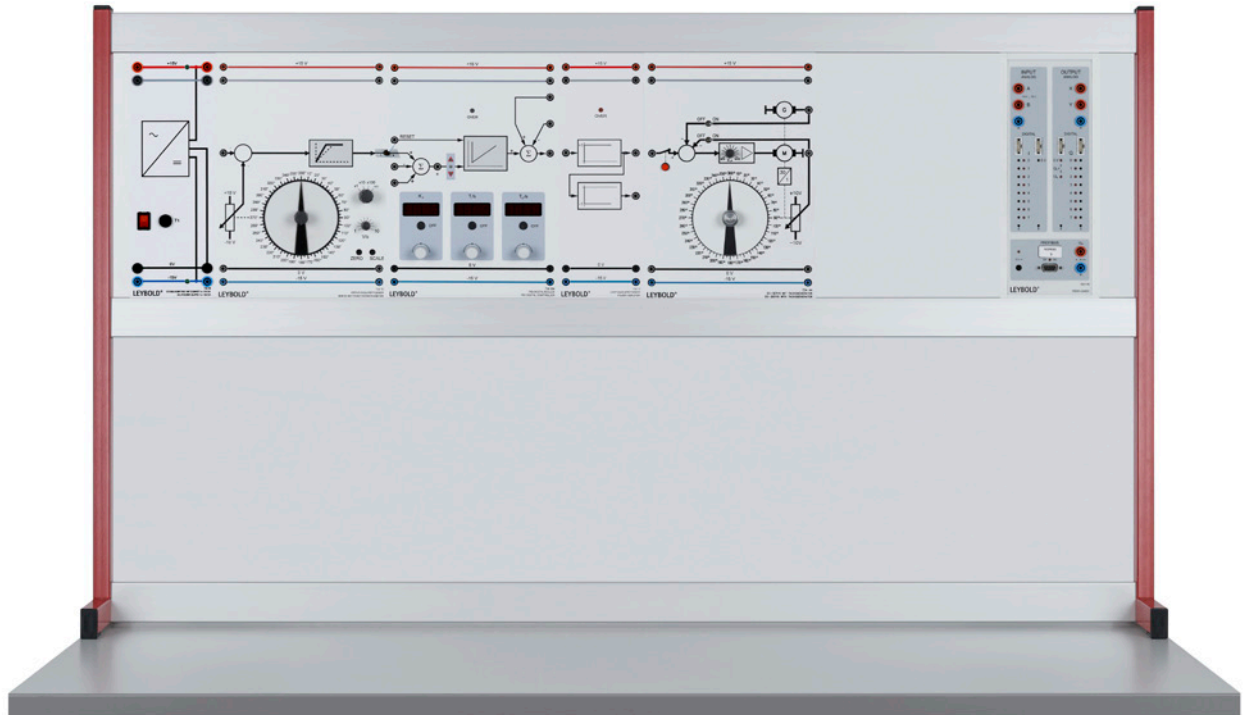

DC Servo (E2.6.1.2)

Cat. No.	Description	E2.6.1.2
734 10	Servo setpoint generator	1
734 13	Power amplifier	1
734 44	DC servo with tachogenerator	1
734 064N	PID digital controller Net	1
725 007	Software: Leylab.control Lite	1
524 016S2	Profi-CASSY Starter 2	1
726 09	Panel frame T130, two-level	1
726 86	Stabilised power supply ± 15 V/3 A	1
579 13	Toggle switch, STE 2/19	1
734 36	Weight disc with hook	1
500 59	Safety bridging plugs, black, set of 10	1
500 851	Safety connecting leads, 32 A, set of 32	1
775 325DE	LIT: E2.6.1.2 DC Servos (German)	1
775 325EN	LIT: E2.6.1.2 DC Servos	1*

* additionally recommended

Servos are drives used for open- and closed-loop control of position, speed or torque. In manufacturing, servos are often used as auxiliary drives for positioning items being worked on by machines. Servos are used in that sphere in CNC machines or robots. The requirements for servos demand high accuracy, dynamic properties and resilience to overloading.

The experiments are carried using training panels in panel frames.

Objectives

- Experiment set-up and wiring according to circuit diagrams
- Working with closed-loop control systems
- Optimisation of servo systems
- Use of computer-controlled measuring interfaces

The equipment set incorporates student experiments which can be carried out in a laboratory safely using safety extra-low voltage. Experiment instructions are contained in a manual in either printed or digital form.

The target group is made up of commercial apprentices and students of power engineering and mechatronics. The course offers introductory experiments at an intermediate level for vocational schools and colleges.

Topics

- Recording of step response
- Determination of $K_{p,crit}$ und T_{crit} and calculation of settings for P, PI and PID systems
- Closed-loop step response for P-controller
- Correction for K_p with respect to integral-action systems
- Step response for PID-controller
- Determination of limiting frequency of servos
- Use of measurement interfaces

The PID digital controller Net (734 064N) can be incorporated into a network. The basic software *LEYLAB.control Lite* or the full version *LEYLAB.control* (725 006) is needed to operate the equipment. An optional non-networkable version is also available.

Educationally Designed Servos

E2.6.1.3
AC Servo

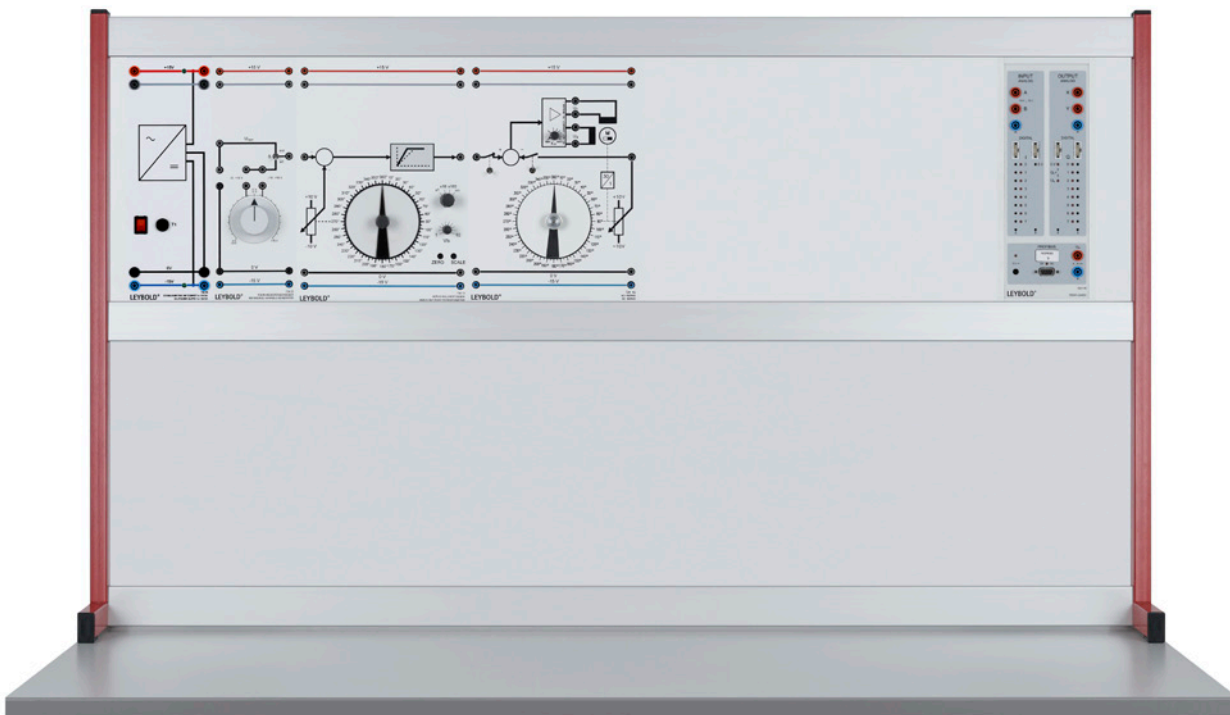

AC Servo (E2.6.1.3)

Cat. No.	Description	E2.6.1.3
734 10	Servo setpoint generator	1
734 45	AC servo	1
734 36	Weight disc with hook	1
579 13	Toggle switch, STE 2/19	1
524 016S2	Profi-CASSY Starter 2	1
726 09	Panel frame T130, two-level	1
726 86	Stabilised power supply ± 15 V/3 A	1
500 59	Safety bridging plugs, black, set of 10	1
500 851	Safety connecting leads, 32 A, set of 32	1
775 330DE	LIT: E2.6.1.3 AC Servos (German)	1
775 330EN	LIT: E2.6.1.3 AC Servos	1*

* additionally recommended

Servos are drives used for open- and closed-loop control of position, speed or torque. In manufacturing, servos are often used as auxiliary drives for positioning items being worked on by machines. Servos are used in that sphere in CNC machines or robots. The requirements for servos demand high accuracy, dynamic properties and resilience to overloading.

The experiments are carried using training panels in panel frames.

Objectives

- Experiment set-up and wiring according to circuit diagrams
- Working with closed-loop control systems
- Optimisation of servo systems
- Use of computer-controlled measuring interfaces

The equipment set incorporates student experiments which can be carried out in a laboratory safely using safety extra-low voltage. Experiment instructions are contained in a manual in either printed or digital form.

The target group is made up of commercial apprentices and students of power engineering and mechatronics. The course offers introductory experiments at an intermediate level for vocational schools and colleges.

Topics

- Open control loops
- Display of voltage across main and auxiliary coils when moving clockwise or anti-clockwise
- Frequencies, synchronous speeds and potentiometer speeds for various desired setpoint values
- Calculation of gear reduction
- Experiments on closed control loops
- Operation with a setpoint integrator
- Response to reversal as a function of the rate of rise in the setpoint
- Response to reversal as a function of the controller gain K_p

Educationally Designed Servos

E2.6.1.4 Stepper Motor



Stepper Motor (E2.6.1.4)

Cat. No.	Description	E2.6.1.4
728 55	Stepper motor	1
524 016S2	Profi-CASSY Starter 2	1
726 09	Panel frame T130, two-level	1
726 86	Stabilised power supply ± 15 V/3 A	1
726 962N	Function generator 200 kHz Net	1
725 007	Software: Leylab.control Lite	1
500 59	Safety bridging plugs, black, set of 10	1
500 641	Safety connecting lead, 100 cm, red	1
500 644	Safety connecting lead, 100 cm, black	1
775 345DE	LIT: E2.6.1.4 Stepper Motors (German)	1
775 345EN	LIT: E2.6.1.4 Stepper Motors	1*

* additionally recommended

For industrial robots, packing machines, NC tooling machines and similar applications, servo drives are needed which are very fast but also very precise in their positioning. These are automatic position-controlled electrical drives, which usually consist of a permanently excited synchronous rotor, a frequency converter with a variable voltage link circuit and digital closed-loop control. A sensor detects the angular position of the motor shaft and uses the information to control the converter.

The experiments are carried using training panels in panel frames.

Objectives

- Experiment set-up and wiring according to circuit diagrams
- Working with closed-loop control systems
- Optimisation of servo systems
- Use of computer-controlled measuring interfaces

Stepper motors are a special variety of synchronous motor with a large number of pole pairs. The rotor follows the stator field in steps, the size of which is determined by the number of poles. With normal loading, the angular position of the rotor can be determined precisely. If overloaded, however, step losses arise and information about the current position of the rotor is lost. Stepper motors can be wired to operate in both half-step and full-step modes. Due to their discontinuous operation, stepper motors are the ideal drive systems for digital servo systems.

The equipment set incorporates student experiments which can be carried out in a laboratory safely using safety extra-low voltage. Experiment instructions are contained in a manual in either printed or digital form.

The target group is made up of commercial apprentices and students of power engineering and mechatronics. The course offers introductory experiments at an intermediate level for vocational schools and colleges.

Topics

- Operation of a simple stepper motor: half-step, full-step
- Design of a stepper motor: function, step angle
- Control methods for bipolar and unipolar stepper motors
- Control program for full and half steps using a unipolar stepper motor
- Control logic with external control
- Dynamic response
- Time constants of the windings
- Rate of rise in current as a function of the clocking frequency
- Starting/stopping regions: start frequencies
- Mechanical resonances: effect of load coupling
- Response as a function of clock frequency

The Function generator 200 kHz Net (726 962N) can be incorporated into a network. The basic software *LEYLAB.control Lite* (725 007) or the full version *LEYLAB.control* (725 006) is needed to operate the equipment. An optional non-networkable version is also available.

Industrial Servos 300 W

E2.6.2.1
AC Servo with
Block Commutation

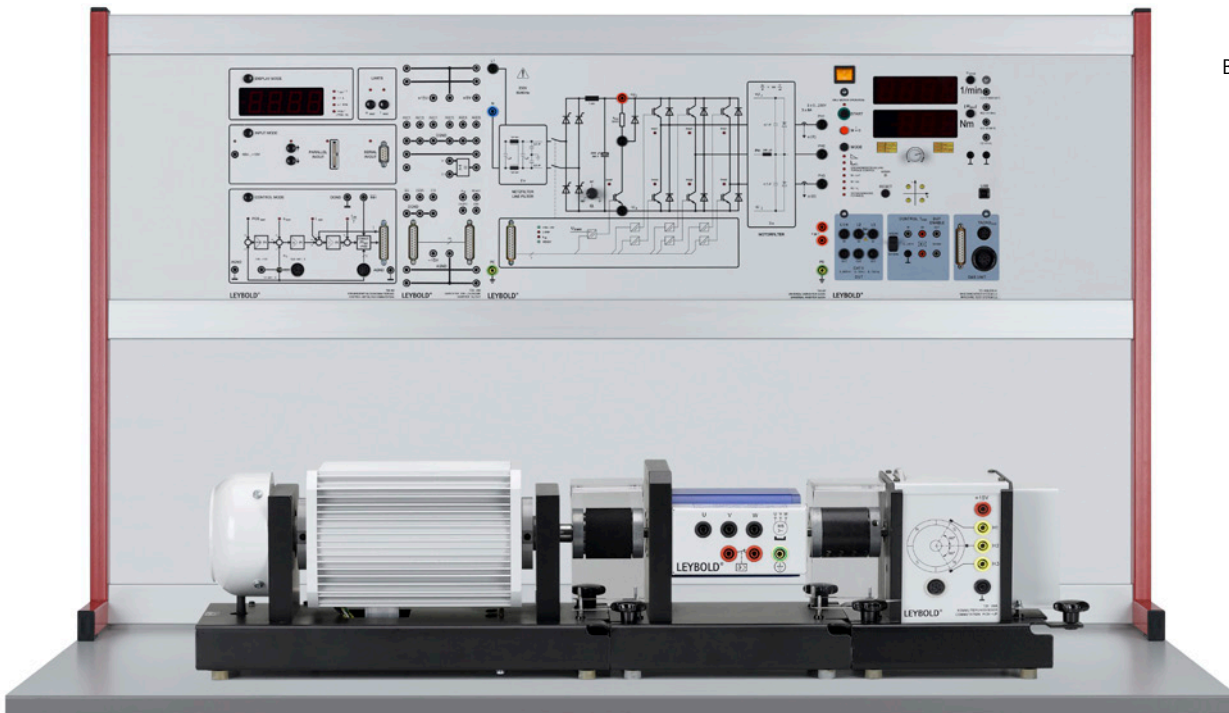

AC Servo with Block Commutation (E2.6.2.1)

Similar to illustration

Cat. No.	Description	E2.6.2.1
734 02	Reference variable generator	1
731 092	Incremental tacho 0.3	1
731 096	Commutation pick-up 0.3	1
731 994	AC servo motor 0.3	1
735 292	Control unit block commutation	1
735 296	Converter input/output	1
735 297	Universal converter 3 x 230 V	1
501 02	BNC cable, 1 m	2
531 282	Multimeter Metrahit Pro	1
575 231	Probe 100 MHz, 1:1 / 10:1	2
575 230	Digital storage oscilloscope 722	1
735 261	Isolation amplifier, four channel	1
731 989USB	Machine test system 0.3	1
728 421	CBM10 MOMO/FCCP	1
728 410	CBC 12.5 Servo technology	1
726 09	Panel frame T130, two-level	1
726 71	Single-phase supply unit	1
726 86	Stabilised power supply ± 15 V/3 A	1
731 06	Coupling 0.3	3
731 07	Shaft end guard 0.3	2
731 081	Coupling guard 0.3 transparent	3
500 59	Safety bridging plugs, black, set of 10	1
500 851	Safety connecting leads, 32 A, set of 32	1
500 852	Safety connecting leads, 32 A, yellow/green, set of 10	1
524 004	Adapter, USB port/serial port	1
729 769	RS-232 cable, 9-pole	1
501 45	Connecting lead, 19 A, 50 cm, red/blue, pair	1
775 305DE	LIT: E2.6.2.1 AC Servo with Block Commutation (German)	1
775 305EN	LIT: E2.6.2.1 AC Servo with Block Commutation	1*

* additionally recommended

For industrial robots, packing machines, NC tooling machines and similar applications, servo drives are needed which are very fast but also very precise in their positioning. These are automatic position-controlled electrical drives, which usually consist of a permanently excited synchronous rotor, a frequency converter with a variable voltage link circuit and digital closed-loop control. A sensor detects the angular position of the motor shaft and uses the information to control the converter.

Power electronics, control equipment, etc. are set up in training panel frames. The servo machine used here is a dynamic industrial machine with a particularly small moment of inertia. The load characteristics can be recorded using the Machine test system 0.3. Power is supplied to the machine under test via a frequency converter especially designed for educational purposes which obtains its power from the mains (mains voltage, 230 V).

Objectives

- Protective measures and electrical safety
- Set-up of power generating systems according to circuit diagrams
- Putting electrical drives into operation
- Recording of load characteristics with various operating parameters
- Achieving skills in measuring electrical machines
- Automatic speed control for an AC servo machine

An AC servo consists of a permanently excited synchronous rotor, a frequency converter with a variable voltage link circuit and digital closed-loop control. A sensor detects the angular position of the motor shaft and uses the information to control the converter. This equipment set investigates AC servos with block commutation. Advanced experiments can be found in the equipment set E2.6.2.3 Position Servo Control.

Topics

- Coupling of motor and commutation sensor
- Steady-state response
- Load characteristics
- Measurement of motor current
- Variation of duty cycle
- Variation variable voltage link
- Variation of commutation angle
- Dynamic response
- Structure of the controlled system
- Stress cycle with servo position control

Industrial Servos 300 W

E2.6.2.2
AC Servo with
Sine Commutation

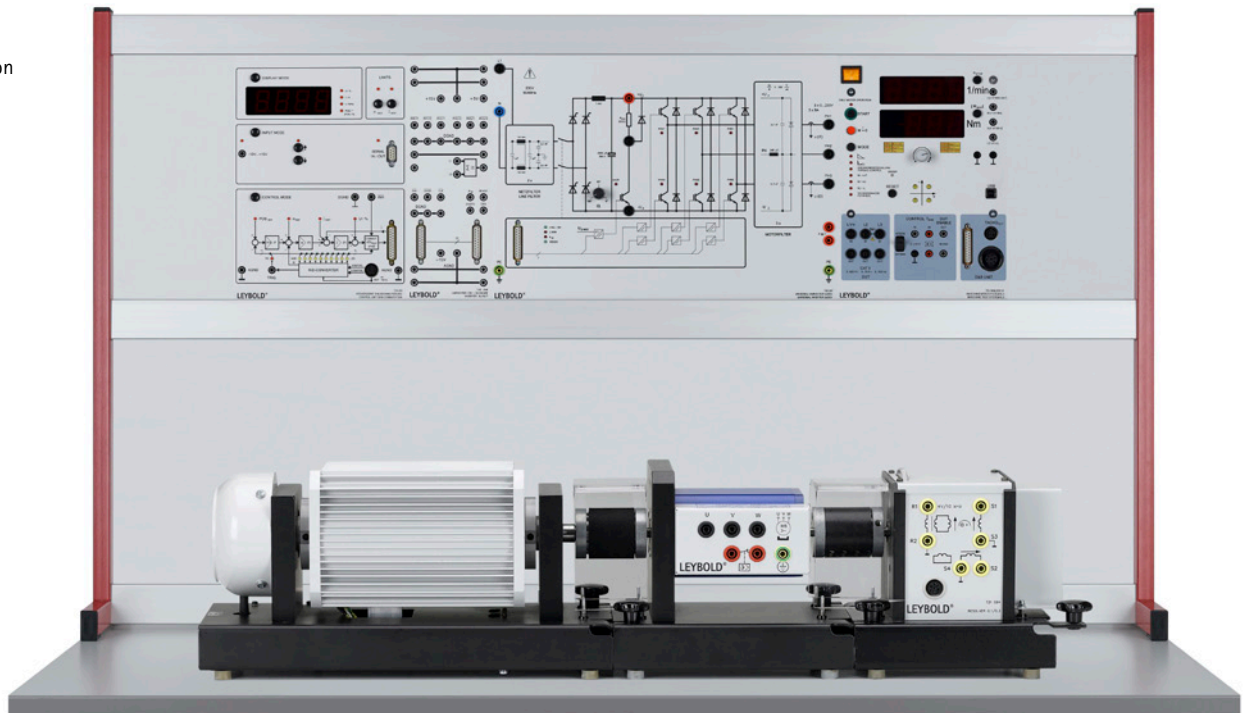

AC Servo with Sine Commutation (E2.6.2.2)

Similar to illustration

Cat. No.	Description	E2.6.2.2
734 02	Reference variable generator	1
731 094	Resolver 0.3	1
731 994	AC servo motor 0.3	1
735 293	Control unit sine commutation	1
735 297	Universal converter 3 x 230 V	1
735 296	Converter input/output	1
501 02	BNC cable, 1 m	2
531 282	Multimeter Metrahit Pro	1
575 231	Probe 100 MHz, 1:1 / 10:1	2
575 230	Digital storage oscilloscope 722	1
735 261	Isolation amplifier, four channel	1
731 989USB	Machine test system 0.3	1
728 421	CBM10 MOMO/FCCP	1
728 410	CBC 12.5 Servo technology	1
726 09	Panel frame T130, two-level	1
726 71	Single-phase supply unit	1
731 06	Coupling 0.3	3
731 07	Shaft end guard 0.3	2
731 081	Coupling guard 0.3 transparent	3
500 59	Safety bridging plugs, black, set of 10	1
500 851	Safety connecting leads, 32 A, set of 32	1
500 852	Safety connecting leads, 32 A, yellow/green, set of 10	1
501 45	Connecting lead, 19 A, 50 cm, red/blue, pair	5
524 004	Adapter, USB port/serial port	1
729 769	RS-232 cable, 9-pole	1
775 310DE	LIT: E2.6.2.2 AC Servo with Sine Commutation (German)	1
775 310EN	LIT: E2.6.2.2 AC Servo with Sine Commutation	1*

* additionally recommended

Power electronics, control equipment, etc. are set up in training panel frames. The servo machine used here is a dynamic industrial machine with a particularly small moment of inertia. The load characteristics can be recorded using the Machine test system 0.3. Power is supplied to the machine under test via a frequency converter especially designed for educational purposes which obtains its power from the mains (mains voltage, 230 V).

Objectives

- Protective measures and electrical safety
- Set-up of power generating systems according to circuit diagrams
- Putting electrical drives into operation
- Recording of load characteristics with various operating parameters
- Achieving skills in measuring electrical machines
- Automatic speed control for an AC servo machine

Sinusoidally commutated drives are more complex to implement than block-commutated drives, but they do have advantages which can justify the extra complexity. The sensor system uses a so-called resolver, which not only provides very accurate information on the absolute position of the rotor, it also outputs a speedometer voltage reflecting the motor speed. From information on the displacement or angle, signals can be derived which can then be used directly for positioning.

Students work in the power engineering lab with mains voltage. Experiments procedures are contained in a printed manual.

The experiments are designed for intermediate and advanced levels.

Topics

- Coupling of motor and commutation sensor
- Steady-state response
- Load characteristics
- Measurement of motor current
- Variation of peak voltage
- Variation variable voltage link
- Variation of commutation angle
- Dynamic response
- Structure of the controlled system
- Stress cycle with servo position control

Industrial Servos 300 W

E2.6.2.3
Position Servo Control



Position Servo Control (E2.6.2.3)

Cat. No.	Description	E2.6.2.3
734 02	Reference variable generator	1
735 299	Position controller, digital	1
731 075	Gearbox 36:1 / 0.3	1
731 089	Potentiometric angle transducer 0.3	1
731 092	Incremental tacho 0.3	1
731 096	Commutation pick-up 0.3	1
731 994	AC servo motor 0.3	1
735 292	Control unit for block commutation	1
735 297	Universal converter 3 x 230 V	1
735 296	Converter input/output	1
731 085	Linear unit 0.3	1*
734 064N	PID digital controller Net	1
725 007	Software: Leylab.control Lite	1
731 086	Linear unit with position encoder 0.3	1*
735 293	Control unit for sine commutation	1*
731 094	Resolver 0.3	1*
500 621	Safety connecting lead, 50 cm, red	3*
500 622	Safety connecting lead, 50 cm, blue	3*
728 410	CBC 12.5 Servo technology	1
726 09	Panel frame T130, two-level	1
726 71	Single-phase supply unit	1
500 59	Safety bridging plugs, black, set of 10	1
500 851	Safety connecting leads, 32 A, set of 32	1
500 852	Safety connecting leads, 32 A, yellow/green, set of 10	1
531 282	Multimeter Metrahit Pro	1
729 769	RS-232 cable, 9-pole	1
524 004	Adapter, USB port/serial port	1
731 07	Shaft end guard 0.3	2
731 081	Coupling guard 0.3 transparent	4
731 06	Coupling 0.3	4

Cat. No.	Description	E2.6.2.3
775 315DE	LIT: E2.5.2.3 Position Servo Control (German)	1
775 315EN	LIT: E2.6.2.3 Position Servo Control	1*

* additionally recommended

Inverters, control units etc. are mounted in panel frames. The servo machine is a dynamic industrial machine with a particularly small moment of inertia. The power supply for the test machine comes from a didactic frequency converter, which is fed from the mains power source (mains voltage 230 V).

Objectives

- Protective measures and electrical safety
- Set-up of power generating systems according to circuit diagrams
- Putting electrical drives into operation
- Achieving skills in measuring electrical machines
- Automatic speed control for an AC servo machine

Topics

- Dynamic response of AC servo drives with block commutation
- Dynamic response of AC servo drives with sinusoidal commutation
- Investigation of angular acceleration as a function of the maximum current
- Closed-loop position control with or without secondary current and speed controllers
- Investigation of the time needed for position and of overshoot as a function of speed and maximum current as well as ramp time
- Investigation of tracking (delay) errors
- Direct and indirect servo position control using a linear unit
- Direct servo position control via external analog position controller and potentiometric angle sensor
- Simulation of a work process
- Comparison of AC servo drives with block and sinusoidal commutation

The PID digital controller Net (734 064N) can be incorporated into a network. The basic software *LEYLAB.control Lite* or the full version *LEYLAB.control* (725 006) is needed to operate the equipment. An optional non-networkable version is also available.

A close-up photograph of a motor's internal stator assembly. The image shows several copper windings mounted on a grey metal frame. The windings are arranged in a circular pattern, and the metal frame has several circular holes. The lighting is bright, highlighting the metallic surfaces and the intricate details of the motor's construction.

INDIVIDUAL COMPONENTS

IN NUMERICAL ORDER

On the following pages you will find all individual components in numerical order of the catalogue numbers.

Digital hand-held tachometer

For contact-type measurements, battery operated, built-in memory function.

Technical data:

- Range: 1 to 25,000 rpm
- Accuracy: ± 1 rpm
- Display: 5 digits, large 7-segment LCD
- Dimensions: 133 mm x 74 mm x 32 mm
- Weight: 200 g including batteries

Scope of delivery:

Complete with carrying case, 3 batteries, 2 conical adapters and 1 funnel-shaped, 1 measurement disc for the measurement of circumferential velocity, 0.1 m.

313 20	Digital hand-held speedometer
--------	-------------------------------



Plug-in axles, set of 2

Designed to act as the fulcrum about which a lever can rotate (340 831).

Technical data:

- Diameter of axle: 4 mm
- Diameter of plug pin: 4 mm
- Total length: 5.5 cm

340 811ET2	Plug-in axles, set of 2
------------	-------------------------



Rubber rings, set of 50

Circumference (loose): 30 cm each

340 900	Rubber rings, set of 50
---------	-------------------------

Pulley 100 mm Ø, plug-in, pair, set of 2

With cord groove, friction bearing, axial plug-in pin and socket. Plug and socket diameter: 4 mm each

Technical data:

- Effective pulley diameter: 100 mm
- Sockets on pulley disc: 4 in 25 mm

340 921ET2	Pulley 100 mm Ø, plug-in, pair, set of 2
------------	--



Necessary for block and tackle:

1	Set of 2 pulleys, 50 mm	340 911ET2
1	Set of 2 pulleys, 100 mm	340 921ET2
1	Set of 2 pulley blocks	340 930ET2
1	1 Load hook	from 340 87ET2
1	1 Support clip, plug-in	from 314 04ET5
1	1 Demonstration line	309 50

Candles, set of 20

Technical data:

- Length: 15.5 cm
- Diameter: 1.2 cm

459 32	Candles, set of 20
--------	--------------------



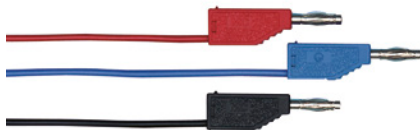
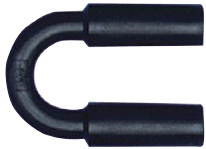
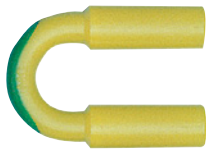

Bridging plugs

Cat.-No.	Designation
500 59	Safety bridging plugs, black, set of 10
500 591	Safety bridging plugs, yellow/green, set of 10
500 592	Safety bridging plugs with tap, black, set of 10
501 48	Bridging plugs, STE 2/19, set of 10

Connecting leads

Cat.-No.	Designation
500 621	Safety connecting lead, 50 cm, red
500 622	Safety connecting lead, 50 cm, blue
500 641	Safety connecting lead, 100 cm, red
500 644	Safety connecting lead, 100 cm, black
500 851	Safety connecting leads, 32 A, set of 32
500 852	Safety connecting leads, 32 A, yellow/green, set of 10
501 44	Connecting leads, 19 A, 25 cm, red/blue, pair
501 441	Connecting lead, 19 A, 25 cm, black, pair
501 45	Connecting lead, 19 A, 50 cm, red/blue, pair

BNC cable, 1 m

Technical data:

- Plugs: BNC/BNC
- Impedance: 50 Ω

501 02	BNC cable, 1 m
--------	----------------

Connecting leads, 19 A, set of 30

For extra-low voltage circuits. Copper wire, equipped at both ends with a plug and fully insulated axial socket for connecting further cables, with tension relief.

Technical data:

- Plugs and sockets: 4 mm diameter (nickel coated)
- Conductor cross section: 1.0 mm²
- Continuous current: 19 A max.
- Contact resistance: 1.8 mΩ

Scope of delivery:

Count	Cat.-No.	Name
3	500 411	Connecting lead, 19 A, 25 cm, red
3	500 412	Connecting lead, 19 A, 25 cm, blue
6	500 414	Connecting lead, 19 A, 25 cm, black
4	500 421	Connecting lead 19 A, 50 cm, red
4	500 422	Connecting lead 19 A, 50 cm, blue
4	500 424	Connecting lead 19 A, 50 cm, black
2	500 441	Connecting lead 19 A, 100 cm, red
2	500 442	Connecting lead 19 A, 100 cm, blue
2	500 444	Connecting lead 19 A, 100 cm, black

501 532	Connecting leads, 19 A, set of 30
---------	-----------------------------------

Light

Cat.-No.	Designation
505 07	Bulbs, 4 V/0.16 W, E10, set of 10
505 08	Bulbs, 12 V/3 W, E10, set of 10
505 11	Bulbs, 2.5 V/0.25 W, E10, set of 10
505 171	Bulbs, 6 V/1.1 W, E10, set of 10
505 191	Bulbs, 15 V/2 W, E10, set of 5



Bulb, 230 V/40 W, E14

Technical data:

- Voltage: 230 V
- Current: 0.18 A
- Power: 40 W
- Socket: E 14

505 27	Bulb, 230 V/40 W, E14
--------	-----------------------



Magnets, 35 mm Ø, pair

Cylindrical magnets (ferrite) with axial bore and coloured north-pole marking.

Technical data:

- Bore diameter: 6.2 mm
- Poles: colour coded
- Diameter: 35 mm
- Height: 20 mm

510 48	Magnets, 35 mm Ø, pair
--------	------------------------



AC/DC power supply, 0...12 V/3 A

With variable and regulated output voltage and analog display instrument, additional 4 AC voltage outputs. AC and DC voltage outputs electrically isolated, therefore especially suitable for students and practical experiments.

Technical data:

- Output voltages: 0 - 12 V DC, continuously adjustable
3, 6, 9, 12 V AC
- Output current: Max. 3 A
- Stabilisation: < 1%
- Residual ripple: 2 mV approx.
- Overload protection, short circuit-protected by means of multifuses, safe from external voltage
- Primary fuse: T 1
- Connections: 4-mm safety sockets
- Connection voltage: 230 V, 50/60 Hz
- Dimensions: 23 cm x 12 cm x 19 cm
- Weight: 5.2 kg

521 485	AC/DC power supply, 0...12 V/3 A
---------	----------------------------------





Function generator S 12

Sine, triangle and square-wave generator, continuous frequency adjustment in six decade ranges, with built-in power amplifier. Ideal for students' experiments because of its small footprint and low-profile design. Safety extra-low voltage power supply.

Technical data:

- Signal waveforms:
 - Sinusoidal, triangular, square-wave
- Frequency range: 0.1 Hz to 20 kHz
- Power output for all types of signal (switchable):
 - 0 to 12 V_{pp} across 8 Ω, continuously adjustable, via 4-mm sockets
- Distortion (sine-wave): < 3% (1 kHz)
- Mark-to-space (square-wave): 1:1
- Rise time (square-wave): 2 μs
- Supply voltage: 12 V AC 50/60 Hz (via power supply unit, included)
- Power consumption: 20 VA
- Dimensions: 6 cm x 12 cm x 7 cm
- Weight: 0.5 kg

522 621	Function generator S 12
---------	-------------------------



Adapter, USB port/serial port

For connecting LD equipment with a serial port to computers with USB ports. Especially tested for ease of operation with CASSY and COM3LAB, including driver CD for Windows and MacOS.

524 004	Adapter, USB port/serial port
---------	-------------------------------

Sensor-CASSY 2

Cascadable interface device for recording measurement data

- For connection to the USB port of a computer, another CASSY module or the CASSY display (524 020USB)
- Sensor-CASSY (524 010), Sensor-CASSY 2 and Power-CASSY (524 011USB) can be mixed in cascades
- 3-fold electrical isolation (4-mm inputs A and B, relay R)
- Measurement possible simultaneously at 4-mm inputs and sensor box connector sites (4 channels)
- Cascading of up to 8 CASSY modules possible (to expand the inputs and outputs)
- Up to 8 analog inputs can be provided by adding Sensor-CASSY sensor boxes
- Automatic sensor box detection (plug and play) by CASSY Lab 2 (524 220)
- Microprocessor-controlled with CASSY operating system (easily updatable via software for function enhancements)
- For use as a bench-top, console or demonstration unit (also in CPS/TPS panel frames)
- Voltage supply 12 V AC/DC via cannon plug or adjacent CASSY module
- Developer Information and LabVIEW™ driver available through our internet homepage

Technical data:

- **5 analog inputs**
- **2 analog voltage inputs A and B** on 4-mm safety sockets (electrically isolated)
 - Resolution: 12 bits
 - Measuring ranges: $\pm 0.1/\pm 0.3/\pm 1/\pm 3/\pm 10/\pm 30/\pm 100/\pm 250$ V
 - Measurement error: $\pm 1\%$ plus 0.5% of range end value
 - Input resistance: 1 MΩ
 - Scanning rate: up to 1 MHz per input
 - Amount of measured values: nearly unlimited (dependent on PC) up to 10,000 values/s, at higher measuring rate max. 200,000 values
 - Pre-trigger: up to 50,000 values per input
- **1 analog current input A** on 4-mm safety sockets (alternatively to voltage input A)
 - Measuring ranges: $\pm 0.03/\pm 0.1/\pm 0.3/\pm 1/\pm 3$ A
 - Measurement error: voltage error plus 1%
 - Input resistance: < 0.5 Ω



Scanning rate: up to 1 MHz per input

See voltage inputs for further data

2 analog inputs at sensor box connector sites A and B

(All CASSY sensor boxes and sensors can be connected)

Measuring ranges: $\pm 0.003/\pm 0.01/\pm 0.03/\pm 0.1/\pm 0.3/\pm 1$ V

Input resistance: 10 k Ω

Scanning rate: up to 500 kHz per input

See voltage inputs for further data

The technical data will change depending on a connected sensor box. In this case CASSY Lab 2 automatically detects the possible measurement quantities and ranges when a sensor box is attached.

- **4 timer inputs** with 32-bit counters at sensor box sites A and B (e.g. for GM box, timer box or Timer S)
Counting frequency: max. 1 MHz
Time resolution: 20 ns
- **5 LED status indicators** for analog inputs and USB-port
Colours: red and green, according to status
Light intensity: adjustable
- **1 change-over relay** (switching indication via LED)
Range: max. 250 V/2 A
- **1 analog output** (LED switching state indicator, e.g. for holding magnet or supplying experiment)
Variable voltage range: max. 16 V/200 mA (load $\geq 80\Omega$)
- **12 digital inputs** (TTL) on sensor box sites A and B (at present only used for automatic sensor box detection)
- **6 digital outputs** (TTL) on sensor box sites A and B (at present only used for automatic switching of a sensor box measuring range)
- **1 USB port** for connection to a computer
- **1 CASSY bus** for connecting additional CASSY modules
- Dimensions (WxHxD): 115 mm x 295 mm x 45 mm
- Weight: 1.0 kg

Scope of delivery:

- Sensor-CASSY 2
- CASSY Lab 2 software, without activation code, with comprehensive help function (16 full-functionality sessions free, then usable as demo version)
- USB cable
- Plug-in supply unit 230_V, 12_V/1.6_A

524 013	Sensor-CASSY 2
---------	----------------

Sensor-CASSY 2 Starter

Voltage and current input are already integrated into the Sensor-CASSY module. Therefore following experiments can be implemented without additional sensors:

- Voltage and current measurement
- Ohm's law
- Electric oscillations
- Characteristic curves
- AC circuit
- Active power

Scope of delivery:

Count	Cat.-No.	Name
1	524 013	Sensor-CASSY 2
1	524 220	CASSY Lab 2

524 013S	Sensor-CASSY 2 Starter
----------	------------------------



Profi-CASSY Starter 2



The Profi-CASSY starter package is intended for unlimited experimentation. It consists of a Profi-CASSY module with interface (524 016), plus CASSY Lab 2 software (524 220).

Technical data:

- **16 digital inputs I0 to I15**
 - (5 V or 24 V logic)
 - Sampling rate: max. 100 values/s
- **16 digital outputs, Q0 to Q15**
 - (5 V or 24 V logic)
 - Output current: 10 mA with internal 5 V power supply, 500 mA via external power supply of up to 30 V
 - Total current: 2 A

The digital inputs/outputs are each equipped with 10-pin plugs for direct connection to automation equipment. Also 8 inputs and 8 outputs are additionally equipped with 2-mm sockets and status LEDs
- **2 analog voltage inputs, A and B**
 - 4-mm safety sockets
 - Resolution: 12 bits
 - Amplitude: ± 10 V
 - Measuring error: $\pm 1\%$ plus 0.5% from the end value of range
 - Input resistance: 1 M Ω
 - Sampling rate: max. 10,000 values/s
- **2 analog outputs, X and Y**
 - 4-mm safety sockets
 - Amplitude: ± 10 V
 - Output current: max. 100 mA per Output
 - Resolution: 12 bits, measuring error: $\pm 1\%$ plus 0.5% from the end value of range
 - Sampling rate: 10,000 values/s
- **1 PROFIBUS connection**
 - 9-pin DSUB socket
 - Passive user (slave) on fieldbus
 - PROFIBUS-DP
 - Address adjustable via software with 16 digital inputs/outputs
 - Transmission rate up to max. 3 Mbits/s
- **USB port**
 - for connection to PC
- **1 CASSY-Bus module**
 - or connection to Sensor- or Power-CASSY modules
- **Dimensions (BxHxT):** 115 mm x 295 mm x 45 mm
- **Weight:** 1 kg

Scope of delivery:

- 1 Profi-CASSY module
- CASSY Lab software with enable code for Windows XP/Vista/7/8 (32+64 bit) and extensive help
- 1 Installation guide
- 1 USB cable
- 1 power adapter 230/12 V/1.6 A
- 1 GSD file for simple parameter settings

524 016S2	Profi-CASSY Starter 2
-----------	-----------------------

Multimeter LDanalog 20



High overload-capacity measuring instrument with integrated protection against damage due to improper handling, specially designed for student's and practical experiments. The moving coil instrument is protected against damage with two diodes connected in opposing directions. Automatic battery cut-out after approx. 45 min.

Technical data:

- DC voltage ranges: 0.1 ... 300 V (8 ranges)
- AC voltage ranges: 3 ... 300 V (5 ranges)
- DC current ranges: 0.1 mA to 3 A (6 ranges)
- AC current ranges: 0.1 mA to 3 A (5 ranges)
- Internal resistance: 10 M Ω/V (\approx)/6.67 k Ω/V (\sim)
- Accuracy: class 2/3 \sim
- Zero point: left/centre (switchable)
- Mirror scale: yes
- Batteries (included): 9 V, 6 x F22 (685 45ET5)
- Overload capacity/fuses: F 3.15 A/300 V fuses
- Dimensions: 10 cm x 14 cm x 3.5 cm
- Weight: 270 g

531 120	Multimeter LDanalog 20
---------	------------------------

Digital multimeter DMM120

Compact multimeter with large-format 3 3/4 digit display, automatic or manual range selection, backlit display, automatic display of function symbols and low-battery indication, automatic cut-off, 1 impact-resistant case, 1 set of test leads with probes (red/black).

Technical data:

- 5 DC voltage ranges: 0.1 mV to 600 V
- 5 AC voltage ranges: 0.1 mV to 600 V
- 5 DC current ranges: 0.1 μ A to 10 A DC
- 5 AC current ranges: 0.1 μ A to 10 A
- Internal resistance: 10 M Ω DC/AC
- 6 resistance ranges: 0.1 Ω to 40 M Ω
- 5 capacitance ranges: 0.01 nF to 100 μ F
- 6 frequency ranges: 0.01 Hz to 20 MHz
- Continuity test/diode test
- HOLD measured value memory
- DC voltage accuracy: $\pm 0.5\%$ + 2 digits
- AC voltage accuracy: $\pm 1.0\%$ + 4 digits
- DC current accuracy: $\pm 1.2\%$ + 2 digits
- AC current accuracy: $\pm 1.5\%$ + 4 digits
- Batteries: 2 x 1.5 V, IEC R6
- Overload capacity: 500 V rms
- Fuses: 500 mA/250 V (5x20 mm) and 10 A, HP 600 V
- Vmax CAT II: 600 V
- Dimensions: 16.5 cm x 8.5 cm x 4.0 cm
- Weight: 260 g



531 172	Digital multimeter DMM120
---------	---------------------------

Digital multimeter 3315

Digital multimeter with 3 3/4-digit CD display (3999 max.), 40 segment bar graph and function symbols. Special features: USB and RS232 ports, measurement of capacitance, frequency and temperature, diode- and continuity-testing functions plus signal output and buzzer, Data, Min, Max, Rel. functions, auto shut-off (time selectable). Safety: TÜV/GS, IEC-1010-1; CAT III 1000 V, CAT IV 600 V.

Technical data:

Measuring ranges:

- DC voltage: 400 mV/4/40/400/1000 V, $\pm 0.8\%$ + 1 digit
- AC voltage: 4/40/400/750 V, $\pm 1.0\%$ + 5 digit
- DC current: 400 μ A/4/40/400 mA/10 A, $\pm 1\%$ + 2 digit
- AC current: 400 μ A/4/40/400 mA/10 A, $\pm 1.5\%$ + 5 digit
- Resistance: 400 Ω /4/40/400 k Ω /4/40 M Ω , $\pm 1\%$ + 2 digits
- Capacity: 4/40/400 nF/4/40/400 μ F/4/40 mF; $\pm 4\%$ + 3 digits
- Frequency: 4/40/400 kHz/4/40/400 MHz, $\pm 0.1\%$ + 3 digits
- Temperature: -40 ... +1000°C $\pm 1\%$ + 3 digits
- Dimensions (WxHxD): 100 x 210 x 45 mm
- Weight: 0.33 kg

Scope of delivery:

- Test leads
- testing terminal
- battery
- Type K - Thermocouple
- interface cable USB and RS 232
- software for Windows 95/98/2000/XP/NT
- operating instructions

531 2741	Digital multimeter 3315
----------	-------------------------



Multimeter Metrahit Pro



Special features:

- Automatic socket blocking prevents the measuring leads from being inserted into the wrong sockets.
- Automatic and manual battery cut-off
- Safety warning for fuse triggering and overload
- Automatic and manual range selection
- True root mean square measurement: TRMS
- Digital display: 65 mm x 36 mm
4 1/2 digits ±12000 maximum readings
- Automatic scaling of analog display
- Electromagnetically compatible design (EMC)
- Set of safety leads

Technical data:

- DC voltage ranges: 100 mV ... 1000 V
- AC voltage ranges: 100 mV...1000 V
- DC current ranges: 1 A ... 10 A
- AC current ranges: 1 A ... 10 A
- Resistance measuring ranges: 100 Ω ... 40 MΩ
- Frequency: 100 Hz ... 30 kHz
- Temperature: -250 ... +1372°C
- Resolution: 10 μV; 100 μA; 10 mW; 0.01 Hz; 0.1°C
- Continuity/diode test: yes
- TRMS: AC and AC+DC, 10 kHz
- Inherent discrepancy in DC voltage: 0.05% of measured value/±3 digits
- Batteries (included): 2 x AA IEC LR6
- Overload capability:
Voltage ranges: 1000 V
Current: 10 A
- Fuses FF (UR) 10A/1000 V AC/DC
- Dimensions 87 mm x 200 mm x 45 mm
- Weight: approx. 400 g

531 282 | Multimeter Metrahit Pro

Multimeter METRAport 3A



Multimeter with high overload capacity and special built-in protection against damage resulting from incorrect use; with integrated measuring amplifier for accurate measurements. Control and display fields are each located in different halves of the hinged housing. Closing the housing automatically switches off the battery. The user can tilt the hinged meter display to achieve the optimum viewing angle.

Technical data:

- DC voltage ranges: 0.1 V to 1000 V (9 ranges)
- AC voltage ranges: 0.1 V to 1000 V (9 ranges)
- DC current ranges: 10 μA to 10 A (7 ranges)
- AC current ranges: 10 μA to 10 A (7 ranges)
- Resistance ranges: 1 Ω to 20 MΩ (5 ranges)
- Other measuring ranges: Level (dB scale)
- Internal resistance: 10 MΩ (const.)
- Accuracy: class > 1.5 DC, class 2.5 AC
- Zero point: left
- Mirror scale
- Battery (included): 9 V/IEC 6 F 22 (685 45)
- Overload capacity: all ranges up to 250 V
- Fuses: FF 1.6 G/250 V
- Dimensions: 14.6 cm x 11.8 cm x 4.4 cm
- Weight: 450 g

531 57 | Multimeter METRAport 3A

Insulation tester Metriso C

Battery operated insulation tester as per VDE 0413, Part 1, for testing equipment and systems up to 500 V voltage rating.

Technical data:

Measurement ranges:

- Insulating resistance:
 - 0..500 k Ω
 - 0.4..20 M Ω
- Resistance: 0..1000 Ω (V_0 370 V DC approx.) with audible signal
- Voltage: 0..500 V AC/DC
- For insulation testing:
 - Voltage rating: 500 V
 - Current rating: 1.06 mA
 - Open-circuit voltage: 700 V DC approx.
- Accuracy:
 - Insulation resistance: class 1.5 as per DIN 43 780 or $\pm 30\%$ of reading as per VDE 0413
 - Resistance: class 2.5
 - Voltage: class 2.5
- Overload-protected in all ranges
- Power supply: 4 x mignon (AA) cell, 1.5 V, IEC R6

531 600 Insulation tester Metriso C

Batteries not included



Rheostat, 100 ohms

Resistance wires wound on a special cement core, perforated cover for touch protection, electrical connections via three safety sockets allowing applications as fixed resistor, variable resistor and potentiometer.

Technical data:

- Connection: 4-mm safety sockets
- Resistance: 100 Ω
- Resistor tolerance: 10%
- Max. load:
 - Current (sustained): 1.8 A
 - Current_{max} (15 mins.): 2.5 A
- Dimensions: 450 x 95 x 150 mm

537 34 Rheostat, 100 ohms



Rheostat, 330 ohms

Resistance wires wound on a special cement core, perforated cover for touch protection, electrical connections via three safety sockets allowing applications as fixed resistor, variable resistor and potentiometer.

Technical data:

- Connection: 4-mm safety sockets
- Resistance: 330 Ω
- Resistor tolerance: 10%
- Max. load:
 - Current (sustained): 1.0 A
 - Current_{max} (15 mins.): 1.4 A
- Dimensions: 450 x 95 x 150 mm

537 35 Rheostat, 330 ohms





Resistance wires

To examine the dependence of electric resistances on material, length and cross section of the wire used.

Cat.-No.	Diameter	Length	Cross section	Specific resistor	Material
550 35	0,2 mm	100 m	0,03 mm ²	0,6 Ω/m	Copper
550 39	0,5 mm	50 m	0,2 mm ²	0,4 Ω/m	Brass
550 40	0,2 mm	100 m	0,03 mm ²	15,4 Ω/m	Constantan
550 41	0,25 mm	100 m	0,05 mm ²	10,4 Ω/m	Constantan
550 361	0,3 mm	100 m	0,07 mm ²	7,7 Ω/m	Constantan
550 42	0,35 mm	100 m	0,1 mm ²	5 Ω/m	Constantan
550 43	0,4 mm	50 m	0,12 mm ²	4 Ω/m	Constantan
550 44	0,5 mm	50 m	0,2 mm ²	2,5 Ω/m	Constantan
550 443	0,7 mm	20 m	0,4 mm ²	1,3 Ω/m	Constantan
550 445	1 mm	20 m	0,8 mm ²	0,6 Ω/m	Constantan
550 45	0,2 mm	100 m	0,03 mm ²	34,5 Ω/m	Chrome-nickel
550 46	0,25 mm	100 m	0,05 mm ²	21,3 Ω/m	Chrome-nickel
550 47	0,35 mm	100 m	0,1 mm ²	11 Ω/m	Chrome-nickel
550 48	0,4 mm	50 m	0,12 mm ²	8,2 Ω/m	Chrome-nickel
550 49	0,5 mm	50 m	0,2 mm ²	5,4 Ω/m	Chrome-nickel
550 51	0,2 mm	100 m	0,03 mm ²	3,3 Ω/m	Iron



Plug-in power supply, 12 V AC

Universal plug-in power supply, e.g. for CASSY, counter S, counter P, electrometer amplifier etc.

Technical data:

- Primary: 230 V AC, 50/60 Hz
- Secondary: 12 V AC, 20 VA
- Connection: co-axial power connector

562 791 Plug-in power supply, 12 V AC



Storage tray for ELM apparatus

Specially moulded for apparatus.

Technical data:

- Dimensions: 55 cm x 28.5 cm x 5 cm

563 04 Storage tray for ELM apparatus



ELM pole piece for magnets

With ground, magnetic contact surface and recessed borehole for attachment. Complete with hexagon socket (M6 x 35).

563 091 ELM pole piece for magnets



ELM wide pole piece for coils

For two- and three-pole stator assemblies

563 101 ELM wide pole piece for coils

ELM coil, 250 turns

Technical data:

- Number of turns: 250
- Resistance: 1.8 Ω
- Impedance: 6.7 Ω (at 50 Hz)
- Max. current: 1.5 A

563 11	ELM coil, 250 turns
--------	---------------------

ELM coil, 500 turns

For use with pole pieces.

Technical data:

- Current: 0.7 A
- Connection: 4-mm sockets
- Dimensions: 50 mm x 60 mm x 20 mm

563 115	ELM coil, 500 turns
---------	---------------------

ELM squirrel-cage rotor

Technical squirrel-cage rotor of disc design with pulley, rotor: 90 mm diameter.

563 12	ELM squirrel-cage rotor
--------	-------------------------

ELM brush

Hard carbon contact with press-on spring, cable and 4-mm plug, for connecting to the commutator and slip rings of the coil rotors.

Technical data:

- Max. current: 1.5 A

563 13	ELM brush
--------	-----------

Allen key

For fastening the pole piece with a magnet or a coil to a base plate.

563 16	Allen key
--------	-----------

ELM centring disc

For optimising the distance between the pole pieces and rotors.

563 17	ELM centring disc
--------	-------------------

ELM brush holder rack

For securing the rotor on the axle of a base plate, for 5 brushes. Complete with retaining screw.

563 18	ELM brush holder rack
--------	-----------------------

ELM narrow pole piece for coils

With spigot, for use with coils.

Technical data:

- Allen screw, M6 x 35
- Dimensions: 42 mm x 52 mm x 30 mm

563 201	ELM narrow pole piece for coils
---------	---------------------------------





ELM split pole piece for coils

With spigot, for use with coils.

Technical data:

- Allen screw, M6 x 35
- Dimensions: 83 mm x 60 mm x 30 mm

563 21 | ELM split pole piece for coils



ELM two-pole rotor

Coil rotor on iron cores consisting of packed laminated sheets to eliminate eddy currents, with a pivot bearing, pulley and cable drum.

Technical data:

- Number of turns: 2 x 380
- Ohmic resistance: 1.3 Ω
- Impedance: 5.9 Ω
- Max. current: 1.5 A
- Commutator: two-pole
- Slip rings: 2 (180°)

563 22 | ELM two-pole rotor



ELM three-pole rotor

Coil rotor on iron cores consisting of core sheet sections free of eddy currents, with a pivot bearing, pulley and cable drum

Technical data:

- Number of turns: 3 x 340
- Resistance: 1.6 Ω
- Impedance: 7 Ω
- Max. current: 1.5 A
- Commutator: three-pole
- Slip rings: 3 (120°)

563 23 | ELM three-pole rotor



ELM drum rotor

12 T armature with belt disc.

Technical data:

- Number of turns: 12 x 90
- Current: max. 1.5 A
- Speed: max. 5000 rpm
- Rotor: 90 mm diam.

563 24 | ELM drum rotor



ELM rotating field attachment and squirrel cage ring

With two threaded bores for attaching magnets and pole pieces for generating a rotating magnetic field. The squirrel cage ring can be plugged into the collectors of the coil rotors to make them act as squirrel cage rotors.

563 25 | ELM rotating field attachment and squirrel cage ring



ELM magnetic needle rotor

Magnetic needle with pivot bearing, for demonstrating slowly rotating fields.

563 28 | ELM magnetic needle rotor

ELM aluminium ring with iron disc

Rectangular frame made of aluminium with matching iron disc. Model of a short-circuit rotor; D = 90 mm.

563 29 ELM aluminium ring with iron disc



Oil, 100 ml, in dropping bottle

Acid-free machine oil.

563 31 Oil, 100 ml, in dropping bottle



Two-channel oscilloscope 400

Particularly suitable for demonstration and practical experiments. Includes instruction manual. Probes not included.

Technical data:

- Bandwidth: 0...40 MHz (-3 dB)
- Input impedance: 1 M Ω , 15 pF, max. 400 V
- Screen: 8 x 10 cm with internal graticule
- Vertical deflection: 1 mV/cm...20 V/cm (14 steps)
- Time bases: 100 ms/div...0.2 s/div with X-axis magnification x10 to 10 ns/division
- Trigger sources: Ch1, Ch2, line, ext.
- Operating modes: Ch1, Ch2, Ch1+Ch2 (alternate or chopped), Ch1/Ch2 sum or difference
- XY mode
- Built-in component tester
- Dimensions (WxHxD): 28.5 x 12.5 x 38.0 cm
- Mains supply: 105...253 V, 50/60 Hz \pm 10%, Cat II

575 212 Two-channel oscilloscope 400



Probe 100 MHz, 1:1 / 10:1

For measurements on high-impedance voltage sources in conjunction with oscilloscopes, frequency-compensated. Range selection by switch. Including a spring-loaded hook, trimmer key, BNC adapter, probe tip, insulating cover for the probe tip or for IC measurements, 4-mm adapter, ground lead.

Technical data:

- Input resistance: 1 M Ω and 10 M Ω (at 10 M Ω oscilloscope input)
- Bandwidth: 10 MHz or 100 MHz
- Input voltage: 600 V DC including AC peak
- Connection: BNC plug
- Lead length: 1.2 m
- Ground lead length: 30 cm

575 231 Probe 100 MHz, 1:1 / 10:1



Digital storage oscilloscope 722

Technical data:

- Bandwidth: 0...70 MHz (-3 dB)
- Input impedance: 1 M Ω , 14 pF, max. 200 V
- Display: 16.5 cm, VGA Colour TFT
- Storage operation modes: refresh, average, envelope, peak-detect, roll (unsolicited/triggered), filter, HiRes
- Cursor measurement: ΔV , Δt , Δf , peak-to-peak, mean value, RMS value, etc.
- Dual interface USB B/RS232, 2 x USB A
- Vertical sensitivity: 1 mV/div...10 V/div (1 - 2 - 5 progression)
- DC amplification accuracy: 2%
- Time base: 2 ns/div...50 s/div
- Accuracy: 50 ppm
- Trigger operating mode: flank, video, pulse length, logic, delayed, event
- Trigger source: CH1, Ch2, CH1 and Ch2 alternate, line and external
- Component tester
- Mains supply: 100...240 V, 50...60 Hz, Cat. II
- Protection class I (EN61010-1)
- Dimensions: 28.5 cm x 17.5 cm x 14.0 cm
- Weight: < 2.5 kg
- Without probes

575 230 Digital storage oscilloscope 722



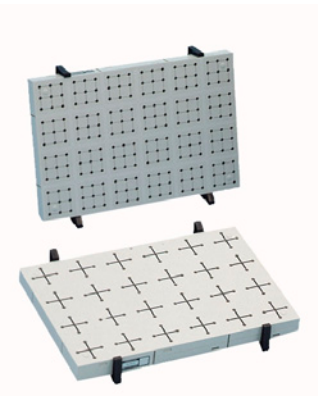

Plug-in board, DIN A4, STE

For assembling electric and electronic experiment circuits for students' and training experiments. The experimenting surface has sufficient capacity for transistor circuits with up to three stages consisting of small plug-in elements in 2/19, 2/50 and 4/50 formats. Also suitable for extending the base and work panels for the electric machine teaching models.

Technical data:

- 24 socket grids
- Front equipped with 24 conductor intersections and 120 sockets
- Rear equipped with 24 conducting squares and 216 sockets
- Dimensions: 30 cm x 20 cm x 2.4 cm

576 74	Plug-in board, DIN A4, STE
--------	----------------------------



Resistor, 4.7 kΩ, STE 2/19

Technical data:

- Load capacity: 2 W
- Tolerance: 5%

577 52	Resistor, 4.7 kΩ, STE 2/19
--------	----------------------------



Resistor, 39 kΩ, STE 2/19

Technical data:

- Load capacity: 0.5 W
- Tolerance: 1%

577 62	Resistor, 39 kΩ, STE 2/19
--------	---------------------------



Capacitor, 4.7 μF, STE 2/19

Technical data:

- Max. allowable voltage: 63 V
- Tolerance: 5%

578 16	Capacitor, 4.7 μF, STE 2/19
--------	-----------------------------



Capacitor (electrolytic), 100 μF, STE 2/19

Technical data:

- Max. allowable voltage: 40 V
- Tolerance: 20%

578 39	Capacitor (electrolytic), 100 μF, STE 2/19
--------	--



Capacitor (electrolytic), 470 μF, STE 2/19

Technical data:

- Max. allowable voltage: 16 V
- Tolerance: 20%

578 40	Capacitor (electrolytic), 470 μF, STE 2/19
--------	--

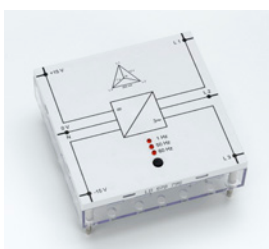

Three-phase voltage supply, 3×12 V, STE 6/100

Plug-in element for generation of a three-phase, alternating sinusoidal voltage.

Technical data:

- Input voltage: ±15 V DC or 12 V AC
- Output frequency: 1, 50 or 60 Hz
- Output voltage: 3×12 V Δ
- Output current: 3×0.2 A

578 795	Three-phase voltage supply, 3×12 V, STE 6/100
---------	---

Lamp holder, E10, top, STE 2/19

Lamp holder with an E 10 screw thread. The lamp is screwed on and placed at the side for the direct, lateral illumination of opto-receivers like photoresistors, photodiodes and photoelements.

579 06	Lamp holder, E10, top, STE 2/19
--------	---------------------------------

Push button (NO), STE 2/19

Mechanical push button with 2 positions.

Technical data:

- Switching functions: ON-OFF

579 10	Push button (NO), STE 2/19
--------	----------------------------

Toggle switch, STE 2/19

Mechanical switch with 2 positions.

Technical data:

- Switching functions: ON-OFF

579 13	Toggle switch, STE 2/19
--------	-------------------------



Advanced Science Kit – Set BEL

15 pieces of basic equipment for one working group to do experiments on electricity and electronics, in pre-formed storage tray.

Scope of delivery:

Count	Cat.-No.	Name
2 out of	340 89ET5	Coupling plugs, 4 mm, set of 5
1	501 48	Bridging plugs, STE 2/19, set of 10
2 out of	501 861	Crocodile-clips, polished, set of 6
1	576 74	Plug-in board, DIN A4, STE
1	576 77	Board holders, STE, pair
2	576 86	Monocell holder STE 2/50
1	577 28	Resistor, 47 Ω, STE 2/19
2	577 32	Resistor, 100 Ω, STE 2/19
2	579 05	Lamp holder, E10, lateral, STE 2/19
1	579 13	Toggle switch, STE 2/19

588 871S	Advanced Science Kit – Set BEL
----------	--------------------------------



Advanced Science Kit – Set ELI 1

8 pieces of supplementary equipment for one working group to do experiments on optics using a ray box. To be stored in the tray for set S24-FN (648 07).

Scope of delivery:

Count	Cat.-No.	Name
1	567 06	Conductors/insulators, set of 6
1	567 18	Wrapping plate for wires
2	579 331	Plug-in holder, STE
1 out of	579 332ET	Leaf spring with contact strip and bimetallic strip
2	582 81	Change-over switch, STE 4/50

588 875S	Advanced Science Kit – Set ELI 1
----------	----------------------------------



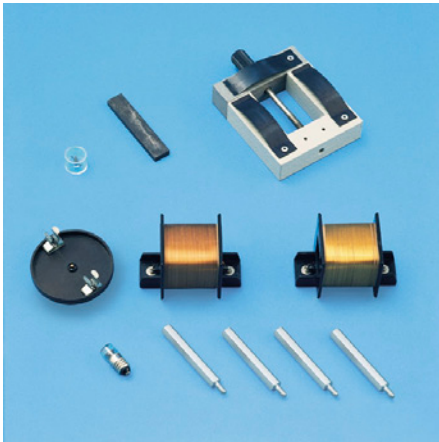

Advanced Science Kit – Set ELI 2

8 pieces of supplementary equipment for one working group to do experiments on electromagnetism and induction. To be stored in the tray for electricity set 1 (588 871S).

Scope of delivery:

Count	Cat.-No.	Name
1 out of	505 36ET10	Glow lamps, 115 V, E10, set of 10
1 out of	510 50ET2	Bar magnets, 60 x 13 x 5 mm, set of 2
1	510 51	Rotary support
1 out of	510 53	Plotting compasses, pair
1 out of	510 54ET2	Magnetisable rods, set of 8
1	590 83	Coil, 500 turns, STE 2/50
1	590 84	Coil, 1000 turns, STE 2/50
1	593 21	Transformer core kit

588 876S Advanced Science Kit – Set ELI 2

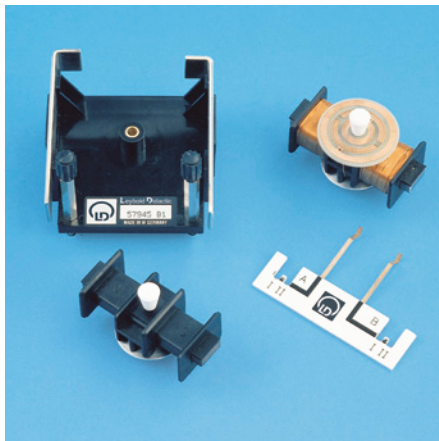

Advanced Science Kit – Set ELI 3

4 pieces of supplementary equipment for one working group to do experiments on motors and generators. To be stored in the tray for electricity set 1 (588 871S).

Scope of delivery:

Count	Cat.-No.	Name
1	579 45	Stator, STE 4/50
1	579 46	Coil rotor, STE
1	579 47	Brush yoke, STE
1	579 48	Magneto inductor, STE

588 877S Advanced Science Kit – Set ELI 3



Scissors, 125 mm, round-ended

Rounded ends.

Technical data:

- Length: 125 mm

667 017 Scissors, 125 mm, round-ended



Batteries, 1.5 V (AA), set of 4

Technical data:

- Voltage: 1.5 V
- Battery type: IEC R6
- Dimensions: 50 mm x 14 mm diameter

685 44ET4 Batteries, 1.5 V (AA), set of 4



Batteries 1.5 V (D, mono), set of 5

Lengths include pole terminals.

Technical data:

- Voltage: 1.5 V
- Battery type: IEC R20
- Dimensions: 60 mm x 33 mm diameter

685 48ET5 Batteries 1.5 V (D, mono), set of 5

USB cable, 3 m

689 0605	USB cable, 3 m
----------	----------------



COM3LAB software

Cat.-No.	Designation
700 00CBTDE	CD: COM3LAB software, German
700 00CBTEN	CD: COM3LAB software, English
700 00CBTFR	CD: COM3LAB software, French
700 00CBTIT	CD: COM3LAB software, Italian
700 00CBTPT	CD: COM3LAB software, Portuguese
700 00CBTRU	CD: COM3LAB software, Russian
700 00CBTSP	CD: COM3LAB software, Spanish

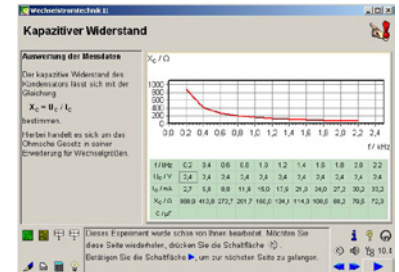

COM3LAB master unit (USB)

For the mounting and supply of power to the COM3LAB multimedia experiment boards. The master unit is connected to the USB Port of a personal computer for the recording of measurements and for remote control of its built-in functions. All the necessary instruments (multimeters, oscilloscope, function generator and digital analyser are built-into the master unit. The master unit itself can be assembled and disassembled quickly. The handy lid protects the master unit and makes it stackable.

Technical data:

- Dimensions: 380 x 282 x 65 mm (L x W x H)

Integrated measuring instruments and functions:

- Two digital multimeters:
 - Voltage: AC/DC 2/20 V
 - Current: AC/DC 0.2/2 A
 - Resistance: 2/20/200 kΩ, 2 MΩ
 - Auto-ranging for all measurement ranges
 - Single button operation
 - Liquid crystal display, 3.5 digits with special characters
- Digital function generator:
 - Digitally generated signal types
 - Sinusoidal, square-wave, triangular, DC
 - 0.5 Hz...100 kHz
 - Max. ±10 V, max. 250 mA
 - Operation via two push buttons and incremental indicator
 - Liquid crystal display, 4-digit with special characters

The following devices have no display of their own and are operated remotely by the connected PC and through the training programs. The measured values are displayed on the PC monitor.

- Digital storage oscilloscope:
 - Two differential voltage inputs with 8-bit A/D converter
 - Measuring ranges: 20/50/100/200/500 mV, 1/2/5 V per division
 - Sampling frequency: 200 Hz to 1 MHz
 - Digital trigger with pre- and post-function
- Digital analyser:
 - Three digital inputs, TTL compatible
 - Sampling frequency: 200 Hz to 1 MHz, up to 4 MHz with limited trigger resolution
 - Triggering from any combination of input states
 - Memory depth 2048 9-bit words

Oscilloscope and analyser can be used in alternation. All of the measuring equipment and function generator are connectable via 2-mm sockets.

USB port included for connection to PC.

Scope of delivery:

- 1 USB cable
- 1 Set of leads consisting of :
 - Connecting leads of 40 cm and 5 cm length equipped with 2-mm plugs
- 1 Table-top power supply, 100...250 V, 50...60 Hz, with mains lead and earth-contact plug for supply of power to the master unit



700 00USB	COM3LAB master unit (USB)
-----------	---------------------------

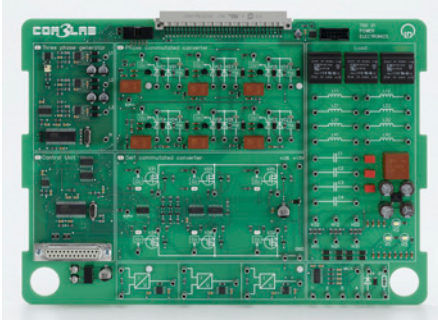

COM3LAB course: Power electronics I

Course on line-commutated and self-commutated static converter circuits, consisting of an experiment board with various circuits for mounting into the master unit and a multimedia CD with interactive training software.

Topics:

- Introduction
- Semiconductors in power electronics
- Wiring and triggering
- Switching processes and commutation
- Uncontrolled rectifier circuits
- Parameters for periodic signals Controlled line-commutated static converters
- M1C circuit
- M3C-circuit
- B2C circuit
- B6C semi-controlled rectifiers

Virtual lab:

- Oscilloscope
- Function generator
- Multimeters (2x)
- Digital analyser

Additional functions:

- Word processing
- Printer
- Pocket calculator
- Free experimentation
- Glossary

The experiment board is powered by the Master Unit.

The wiring of the experiments carried out over 2 mm cable.

Course content, experiment instructions and tasks are taught through a course-specific software.

Scope of delivery:

- Set of cables consisting of 40 cm and 5 cm long connecting leads with 2-mm plugs

700 21	COM3LAB course: Power electronics I
--------	-------------------------------------

- Operating system: Windows 2000/XP/Vista/7

COM3LAB course: Power electronics II

Supplementary course on power inverters, DC choppers, static converters and drive technology, consisting of a dongle for the PE I experiment board and a multimedia CD with interactive training software.

Topics:

- Self-commutated static converters (power inverters)
- Semiconductor switches and controllers (bidirectional static converters)
- Switches and controller for DC
- Converters
- Static converters in automatic control technology
- Static converters in drive technology

Virtual lab:

- Oscilloscope
- Function generator
- Multimeters (2x)
- Digital analyser

Additional functions:

- Word processing
- Printer
- Pocket calculator
- Free experimentation
- Glossary

The experiment board is powered by the Master Unit.

The wiring of the experiments carried out over 2 mm cable.

Course content, experiment instructions and tasks are taught through a course-specific software.

700 22	COM3LAB course: Power electronics II
--------	--------------------------------------

Additionally required:

Count	Cat.-No.	Name
1	700 21	COM3LAB course: Power electronics I
1		PC with Windows XP/Vista/7

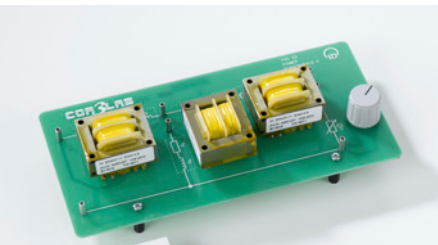

COM3LAB course: Three-phase technology

This COM3LAB course investigates the behaviour of three-phase systems. Practical exercises show the generation of the rotary field or the function of a transformer. Furthermore, passive components in different circuits are discussed. Coils, capacitors and resistors are analysed and evaluated in different circuits.

Topics:

- Characteristics of a three-phase system
- Representation of line diagrams and phase relationships
- Star-delta circuits with different loads
- Measurement of phase and line voltage/current
- Resistive loads
- Capacitive loads
- Symmetrical and unsymmetrical charges
- Measurement of power in the three-phase system

Virtual lab:

- Spectrum analyser (FFT module)
- Frequency counter
- Multimeters (2x)
- Function generator
- Digital storage oscilloscope

Additional functions:

- Web-based training
- You can write your own pages and experiments
- Access to external programs (as for example Excel, Word).
- Subsequent processing of measured data using external programs (as for example Excel, Word).
- You can produce your own documents.
- The software contains a text editor and allows for free experimentation.

Technical data:

- Star circuit with resistors
- Delta circuit with resistors
- Capacitors
- Load resistors

700 24 COM3LAB course: Three-phase technology

- Prerequisites: Fundamentals of AC technology

COM3LAB course: Electrical machines I

Course concerning the connection methods and the recording of characteristics for electric motors and generators. With the integrated machine test system, a multitude of experiments can be carried out, e.g. the recording of torque, power and current-locus curves.

Topics:

- Forces in a magnetic field
- Measurement of Lorentz force
- Drives
- Torque-speed characteristic
- Machine test system
- DC machines
- Speed and induced voltage with DC machines
- Torque and armature voltage with DC machines
- Torque and excitation voltage with DC machines
- DC machines with external excitation
- Reversible of direction
- Characteristics with variable armature voltage
- Characteristics with variable excitation voltage
- Shunt-wound DC machines
- Characteristics with variable operating voltage
- Series-wound DC machines
- Reversal of direction with DC machines
- Characteristics with variable operating voltage
- Generator operation of DC machines
- Drive and generator with a resistive load
- Power output of generator
- Rotating field (three-phase) machines
- Three-phase windings
- Rotating fields
- Direction of rotation with periodic swapping of phase conductors

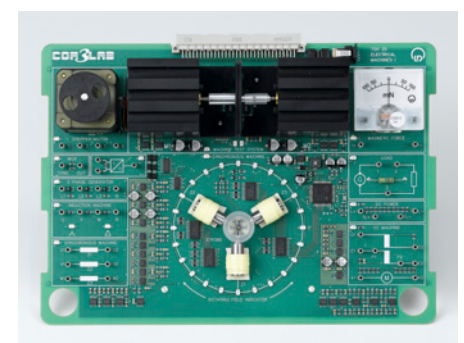
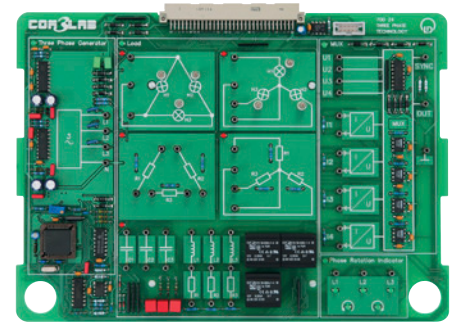

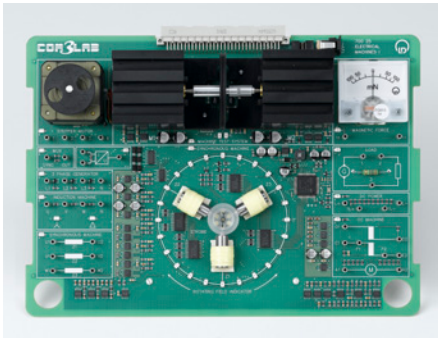

- Direction of rotation when phase conductors are swapped
- Voltage and current in star (Y) circuits
- Voltage and current in delta circuits
- Resistance in stator winding
- Reactance of an AC winding
- Synchronous machines
- Equivalent circuit diagram for synchronous machines and how they are used
- Permanently excited synchronous machines
- Step operation of synchronous machines
- Determining rotor position in star configuration
- Determining rotor position in delta configuration
- Synchronous machine at variable speed (run-up)
- Speed measurement
- Speed setting using frequency converter
- Asynchronous machines
- Block and equivalent circuit diagrams for asynchronous machines
- Determination of slip
- Star-delta starting
- Measurement of torque and line currents during run-up
- Changing direction of asynchronous machines
- Recording of torque-speed characteristic for asynchronous machines
- Three-phase drives
- Changing speed of asynchronous machines
- How speed depends on slip
- How speed depends on stator frequency
- Stepper motors
- Full-step operation
- Half-step operation
- Changing the direction of a stepper motor

Virtual lab:

- Multi-channel oscilloscope
- Oscilloscope
- Function generator
- Multimeter (2x)
- Digital analyser

Additional functions:

- Word processing
- Printer
- Pocket calculator
- Free experimentation
- Glossary

The experiment board is powered by the Master Unit.

The wiring of the experiments carried out over 2 mm cable.

Course content, experiment instructions and tasks are taught through a course-specific software.

Technical data:

- Synchronous machine with optical rotary field indicator and strobe for speed determination
- Induction motor with star-delta switch
- Optical tachogenerator
- DC motor
- DC generator
- Current-torque converter
- Thermometer
- Electronic load
- Three phase generator, phase voltage: 0 V .. 10 V,
- Frequency converter, Frequency: 1 Hz - 80 Hz
- DC supplies
- Stepper motor
- Electrodynamic force meter
- Multiplexer

Scope of delivery:

- Board for course
- CD with software and documentation
- Power supply, 230/12 VAC

700 25	COM3LAB course: Electrical machines I
--------	---------------------------------------

- Working through this course requires the COM3LAB Master Unit 70000USB.
- Also required is a PC running Windows XP, 7 or 8.
- Prerequisites: Fundamentals of AC and three-phase technology

COM3LAB course: Control technology I

Course on the fundamentals of automatic control technology, consisting of an experiment board with various circuits for mounting into the master unit and a Multimedia CD with an interactive training program.

Topics:

- Introduction
- Open-loop control
- Closed-loop control
- Analysis of controlled systems
- Controlled systems with/without compensation
- Controlled systems of a higher order
- Types of controllers
- P, I, PI, PID and PD control
- Automatic digital control
- Performance criteria for automatic controls
- Optimisation guidelines for PID controllers
- Automatic temperature control
- Automatic speed control
- Automatic light control
- Automatic control of systems without compensation
- Automatic control with discontinuous controllers
- Fault simulation

Virtual lab:

- Oscilloscope
- Function generator
- 2 multimeters
- Digital analyser
- Static characteristic plotter
- Step response plotter
- DDC plotter
- Controller design calculator (for optimum controller parameters)

Additional functions:

- Word processing
- Printer
- Pocket calculator
- Free experimentation
- Glossary

The experiment board is powered by the Master Unit.

The wiring of the experiments carried out over 2 mm cable.

Course content, experiment instructions and tasks are taught through a course-specific software.

Technical data:

- Analog controller
- Summation points with disturbance inputs
- Digital controller
- Lag element
- DC signal sources 1V, 5V, 10V
- P-action element
- PT-1 elements (2 x)
- I-action element, resettable
- Non-linear characteristic element
- Speed controlled system with optical speed sensor
- Temperature controlled system with KTY-temperature sensor
- Light controlled system with photodiode sensor and external light source (disturbance source)

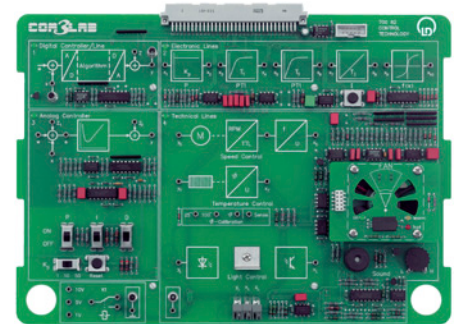

700 82 COM3LAB course: Control technology I

- Operating system: Windows XP/Vista/7
- Support for unguided, free experimentation

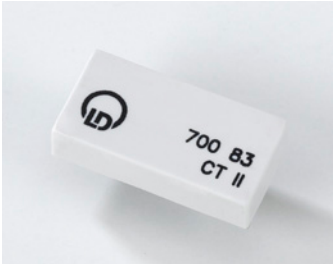

COM3LAB course: Control technology II

Supplementary course on the fundamentals of control technology including a dongle for the CTI experiment board.

Topics:

- Introduction
- Stability of automatic control systems
- Controller design using the Ziegler/Nichols method
- Systems with lag time
- Limiting the manipulated variable
- Cascade control
- Introduction to frequency response
- Frequency response of single basic elements
- Frequency response of combined elements
- Controller design in the frequency domain
- Fuzzy control
- Adaptive control
- Experiments with external controlled systems

Virtual lab:

- Static characteristics plotter
- Step response plotter
- DDC plotter
- Frequency response plotter
- Controller design calculator (for optimum controller parameters)

700 83	COM3LAB course: Control technology II
--------	---------------------------------------

- Operating system: Windows 2000/XP/Vista/7
- Support for unguided, free experimentation.
- Additionally required: 70082COM3LAB course, Control Technology I

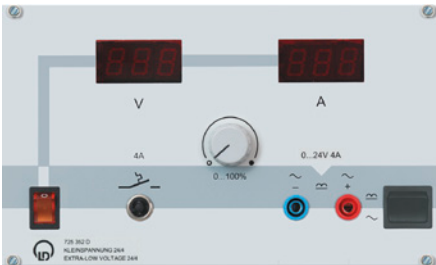

Extra-low voltage supply 24/4

Complete power supply in a 19" casing for supplying DC and AC voltage in the extra-low voltage range.

Technical data:

- Mains switch, illuminated
- Outputs are switchable:
AC voltage: 0...24 V/4 A, floating earth
DC voltage: 0...24 V/4 A floating earth (full-wave rectifier)
- Output protection: thermal circuit-breaker, 4 A
- Display: 2 digital indicators for RMS value (digit height 12.4 mm) for indication of current and voltage
- Outputs: 2 x 4-mm safety sockets
- Width: 42 PU

725 352DG	Extra-low voltage supply 24/4
-----------	-------------------------------

Similar to illustration



Three-phase voltage supply 10/17.3

Complete power supply in a 19" casing for extra-low three-phase voltage.

Technical data:

- Mains switch: cam switch, 3-pole
- Mains voltage: 3 x 400 V ±10%, 50...60 Hz
- Outputs:
3 x 17.3 V (delta), floating earth
3 x 10 V (star), floating earth
- Output protection: 3 x thermal circuit-breakers, 5 A
- Outputs: 4 x 4-mm safety sockets
- Width: 42 PU

725 432G	Three-phase voltage supply 10/17.3
----------	------------------------------------

Three-phase voltage supply 400 V/2.5 A

Complete power supply in a 19" casing for variable three-phase voltage.

Technical data:

- Mains switch: 4-pole cam switch
- Mains voltage: 3 x 400 V $\pm 10\%$, 50 - 60 Hz
- Outputs:
 - 3 x 0 - 400 V AC
 - 1 x 0 - 250V DC (full-wave rectified)
 - 2.5 A, short-term 3 A
- Output protection: 3 x protective circuit breakers Outputs via five 4-mm safety sockets
- Display: 2 digital indicators (digit height 12.4 mm) to display current for L1, L2, L3 (switchable) and voltage
Switchable between:
 - Live conductors/neutral conductor
 - Live conductor/live conductor
- 3 x phase indicator lamps
- Width: 70 PU

725 442DG Three-phase voltage supply, 400 V/2.5 A

Similar to illustration



Three-phase supply / experiment transformer

Complete power supply in a 19" casing for experiments with variable transformer voltages and for extra-low three-phase voltage.

Technical data:

Variable transformer with three taps

- Mains switch, illuminated
- Outputs:
 - 0...24 V/2 A AC voltage, floating earth
 - 0...12 V/4 A AC voltage, floating earth
 - 0...6 V/8 A AC voltage, floating earth
 - 0...3 V/16 A AC voltage, floating earth
- Bridge rectifier 35 A, for all ranges
- Protection: thermal circuit-breaker, 1.2 A, in the primary circuit of the output transformer
- Outputs: 8 x 4 mm safety sockets

Power supply unit for extra-low three-phase voltage

- Mains switch: cam switch, 3-pole
- Mains voltage: 3 x 400 V $\pm 10\%$, 50...60 Hz
- Outputs:
 - 3 x 17.3 V (delta), floating earth
 - 3 x 10 V (star), floating earth
- Output protection: 3 x thermal circuit-breakers, 5 A
- Outputs: 4 x 4 mm safety sockets
- Width: 84 PU

725 579G Three-phase supply / experiment transformer

Similar to illustration



Three-phase generator in case

For generating DC, AC or three-phase AC voltages for the ELM system. Complete power supply in a 19" housing equipped with illuminated mains switch.

Technical data:

- Output voltage, AC: 0...15 V/ 1.5 A
- Output voltage, DC: 0...15 V/ 1.5 A
- Input: 6 pole DIN socket for rotor position pick-up
- Outputs: six 4-mm-safety sockets
- Display: 2 digital displays (digit height 12.4 mm) to display voltage, frequency, speed or position
- Width: 49 PU
- Power supply: 230 V, 50/60 Hz

725 721G Three phase generator in case





DC machine supply 0.3

Complete power supply in a 19" casing for recording the constant-current characteristic of electrical machines with a constant voltage in the power category up to 0.3 kW.

Technical data:

- Mains switch, illuminated
- Output: 40 - 250 V/0 - 6 A DC voltage and current adjustable, stabilised, short circuit-proof, with power factor adjustment
- Output: 220 V/2 A direct current (full-wave rectifier)
- Protection: circuit breaker, 2 A
- Outputs: 4 x 4-mm safety sockets
- Display: 2 digital displays (digit height: 12.4 mm) for indicating current and voltage
- Current overload indicator: 1 red LED
- Change-over switch: V/V ext. (constant), with mode indicator, 1 green LED
- External constant-voltage power supply: (0 - 10 V DC) via 2 x 4-mm safety sockets
- Width: 63 PU

725 852DG	DC machine supply 0.3
-----------	-----------------------



DC machine supply 1.0

Complete power supply in a 19" casing for recording the constant-current characteristic of electrical machines with a constant voltage in the power category up to 1.0 kW.

Technical data:

- Mains switch, illuminated
- Output: 40 - 250 V/0 - 6 A DC voltage and current adjustable, stabilised, short circuit-proof, with power factor adjustment
- Output: 220 V/2 A direct current (full-wave rectifier)
- Protection: circuit breaker, 2 A
- Outputs: 4 x 4-mm safety sockets
- Display: 2 digital displays (digit height: 12.4 mm) for indicating current and voltage
- Current overload indicator: 1 red LED
- Change-over switch: V/V ext. (constant), with mode indicator, 1 green LED
- External constant-voltage power supply: (0 - 10 V DC) via 2 x 4-mm safety sockets
- Width: 84 PU

725 862DG	DC machine supply 1.0
-----------	-----------------------

Similar to illustration

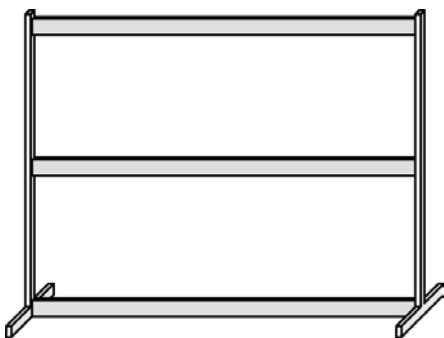

Experiment frames

Cat.-No.	Designation	Stand	Execution
726 09	Panel frame T130, two-level	T-Base	standard
726 10	Panel frame T150, two-level	T-Base	standard
726 11	Panel frame T180, two-level	T-Base	standard
726 18	Panel frame T130, three-level	T-Base	standard
726 19	Panel frame SL85, single-level	L-Base	angled
726 256	Panel frame VT160, three-level	T-Base	heavy duty
726 26	Panel frame VT180, three-level	T-Base	heavy duty

Plug-in board, 297 mm x 300 mm, STE

For suspending directly in panel frames (726 03) or demonstration experiment frames (301 300).

Technical data:

- 24 Socket grids with 24 conducting squares and 216 sockets
- 6 Socket grids with 36 sockets
- 2 Conducting paths with 18 sockets each
- Dimensions: 297 mm x 300 mm x 24 mm

726 50	Plug-in board, 297 mm x 300 mm, STE
--------	-------------------------------------

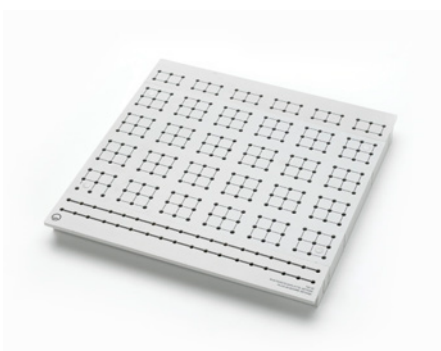

Single-phase supply unit

To switch the mains voltage in experiments with electrical loads for AC voltage of 230 V.

Technical data:

- Cam switch, 2-pole
- Automatic circuit breaker FAZ L 10 A Phase monitor light L 1
- Phase monitor light for indication of false polarity of mains plug

Scope of delivery:

- Mains connecting cable with earth-contact plug

726 71	Single-phase supply unit
--------	--------------------------



Three-phase supply unit with ELCB

To switch the 3-phase supply in experiments with electrical loads for line voltages of 400 V.

Technical data:

- Cam switch, 4 pole
- Earth-leakage circuit breaker, 30 mA
- Motor protection switch, 6-10 A
- Phase indicator lamps L1, L2, L3

Scope of delivery:

- Mains lead with Cekon plug

726 75	Three-phase supply unit with ELCB
--------	-----------------------------------

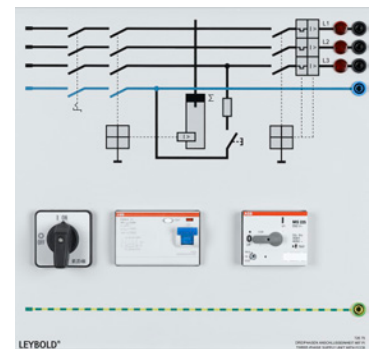

Transformer, 45/90, 3 N

Power supply and experiment unit for the area of power electronics.

Technical data:

- Mains switch: cam switch, 3-pole
- Mains voltage: 3 x 400 V, ±10 %, 50...60 Hz
- Outputs:
 - 3 x 90 V/1.5 A AC with 3 centre taps, 45 V
 - 1 x 230 V/1 A DC
- Motor protection switch 0.63...1 A (prim.)
- Outputs: via eighteen 4-mm safety sockets.
- Mains lead and 16-A Cekon plug

726 80	Transformer, 45/90, 3 N
--------	-------------------------

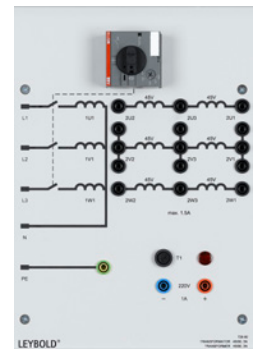

Adjustable transformer 0...260 V

Power supply and experiment unit for the area of electrical machines and energy technology.

Technical data:

- Mains voltage: 230 V, ±10 %, 50...60 Hz
- Output: 1 x 260 V / 4 A AC, short-term 5 A
- 1 Thermomagnetic circuit breaker, 5 A (sec.)
- Output: 2 x 4-mm safety sockets with connecting leads and earth-contact plug, 16 A

726 85	Adjustable transformer 0...260 V
--------	----------------------------------

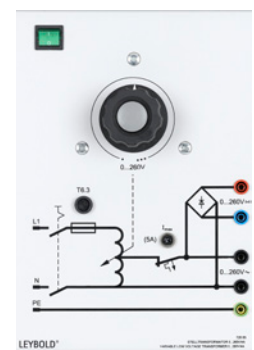

Stabilised power supply ±15 V/3 A

Laboratory power supply with two separate and stabilised fixed voltages for vertical assembly in panel frames or demonstration experiment frames using the plug-in system. Short-circuit-proof. Rated-voltage monitoring via two green LEDs.

Technical data:

- Output voltage: ±15 V via 4-mm sockets
- Maximum load capacity: 2.4 A, short-term 3 A
- Connection voltage: 230 V, 50/60 Hz
- Fuse: T 1.0
- Power consumption: 160 VA
- Dimensions: 10 cm x 30 cm x 12 cm
- Weight: 5 kg

726 86	Stabilised power supply ±15 V/3 A
--------	-----------------------------------

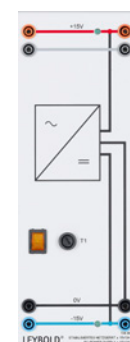

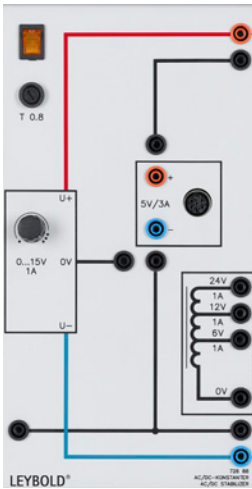

AC/DC stabilizer

Lab power supply unit with DC and AC voltage outputs. For supplying power to logic components of the SIMULOG LS-TTL range in experiments set up vertically in panel frames or demonstration experiment frames.

Technical data:

- Illuminated mains switch
- DC Outputs:
 - Fixed voltage: 5 V/3 A, floating ground
 - Residual ripple: 1 mV_{rms}
 - Tracking stabiliser: $\pm 0...15$ V/1 A, Floating ground
 - Residual ripple: < 3 mV_{rms}
- AC Outputs: 6/12/24 V/1 A, floating ground
 - Outputs: via 4 mm sockets and 6pin DIN socket for adapter/clock
- Mains connecting cable with earth-contact plug
- Dimensions: 15 cm x 30 cm x 12 cm
- Weight: 4 kg

726 88 AC/DC stabilizer

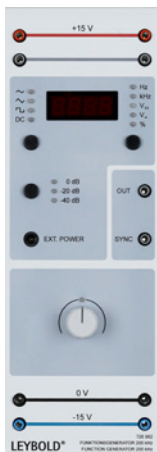

Function generator 200 kHz

Microprocessor controlled signal generator for experiments on training panels.

Technical data:

- Function: Sine/triangle/square/DC
- Square-wave signal: duty cycle 10 %...90 %, adjustable in steps of 5 %
- Frequency range: 100 mHz...200 kHz
- Resolution: 1 mHz...100 Hz, depending on frequency
- Output voltage: 0...20 V_{pp} continuous
- DC offset: ± 10 V
- Display: four-digit 7-segment display for signal parameters and functions
- Attenuation: 0 dB, -20 dB, -40 dB
- output impedance: 50 Ω
- Trigger output: TTL level
- Outputs: 4-mm safety sockets
- Power supply: +/-15 V DC or plug-in adapter, 12 V AC (562 791)

726 962 Function generator 200 kHz

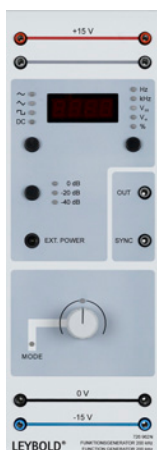

Function generator 200 kHz Net

Microprocessor controlled signal generator for experiments on training panels. Equipped with an RJ 45 socket for connection to a local area network (LAN). Can be controlled by *LEYLAB.control 725006* or *LEYLAB.control Lite 725007* software, allowing parameters to be read or modified and disturbance variables to be introduced. The equipment can be used in the patented „Networked worlds of learning“ system.

Technical data:

- Function: Sine/triangle/square/DC
- Square-wave signal: duty cycle 10%...90%, adjustable in steps of 5%
- Frequency range: 100 mHz...200 kHz
- Resolution: 1 mHz...100 Hz, depending on frequency
- Output voltage: 0...20 V_{pp} continuous
- DC offset: ± 10 V
- Display: four-digit 7-segment display for signal parameters and functions
- Attenuation: 0 dB, -20 dB, -40 dB
- output impedance: 50 Ω
- Trigger output: TTL level
- Outputs: 4-mm safety sockets
- Power supply: +/-15 V DC or plug-in adapter, 12 V AC (562 791)

726 962N Function generator 200 kHz Net

RMS meter

Demonstration meter for measuring true RMS voltages and currents.

- Types of measurement:
 - RMS - AC + DC, overall true RMS
 - RMS - AC, alternating true RMS
 - AV - AC + DC arithmetic average value

It is possible to switch between all ranges and types of measurement at any time.

Technical data:

Measurement ranges for all types of measurement:

- Voltage: 3/10/30/100/300/1000 V, $R_i = 10\text{ M}\Omega$
- Current: 0.1/0.3/1/3/10/30 A, $R_i = 10\text{ m}\Omega$
- AV-Polarity indicator: 2 LEDs
- Instrument:
 - Moving coil
 - Class 2.5
 - 192 x 96 mm (W x H)
 - Scale division: 0...10 and 0...3
 - Scale length: 119 mm
- Continuous overload protection in all measurement ranges up to 1000 V and 30 A
- Mains supply: 110/230 V, 50 Hz*
- Weight: 1.4 kg

727 10 RMS meter

*60 Hz on request



Power meter

Demonstration meter for active power and capacitive and inductive reactive power, in the range 0.3 W (var) to 30 kW (kvar).

Technical data:

Measurement ranges:

- Voltage: 3/10/30/100/300/1000V
- $R_i = 10\text{ M}\Omega$
- Current: 0.1/0.3/1/3/10/30 A
- $R_i = 10\text{ m}\Omega$
- Frequency range:
 - Active power: 0...20 kHz
 - Reactive power: 50 Hz sin
- LED indication for:
 - Active power consumption
 - Active power output
 - Capacitive reactive power
 - Inductive reactive power
 - Overload voltage
 - Overload current
- Instrument:
 - Moving coil
 - Class 1.5
 - 192 x 96 mm (W x H)
 - Scale division: 0...10 and 0...3
 - Scale length: 119 mm
- Continuous overload protection in all measurement ranges up to 1000 V and 30 A
- Mains supply: 110/130/220/240 V, 50 Hz

727 11 Power meter



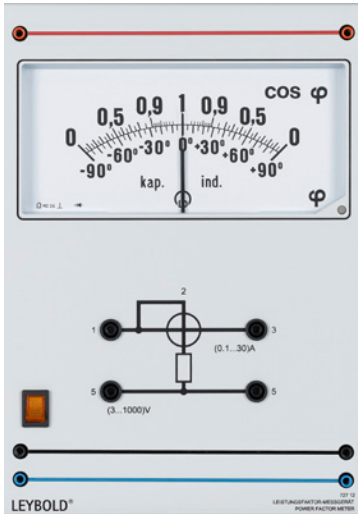

Power factor meter

Demonstration meter for power factor (cos phi) and phase-angle.

Technical data:

Measurement ranges:

- Power factor: 0...1...0
- Phase angle: -90°(cap.)- 0 - +90°(ind.)
- Voltage range: 3...1000 V, $R_i = 1 \text{ M}\Omega$
- Current range: 0.1...30 A, $R_i = 10 \text{ m}\Omega$
- Frequency range: 20 Hz... 2 kHz
- No voltage range/current range switching
- Display instrument:
 - Moving coil
 - Class 1.5
 - 192 x 96 mm (W x H)
 - Scale length: 119 mm
- Continuous overload protection in all measurement ranges up to 1000 V and 30 A- 192 x 96 mm (W x H)
- Mains supply: 110/130/220/240 V, 50 Hz

727 12 | Power factor meter

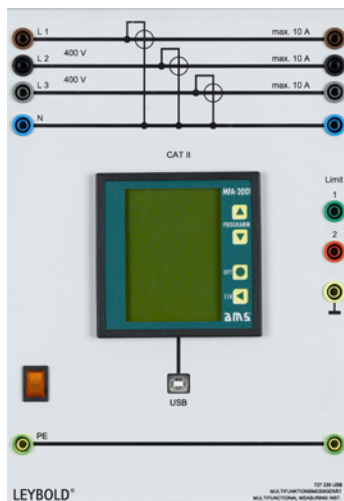

Multi-functional meter

The multi-functional meter is an all-purpose electronic meter for the measurement and monitoring of all important parameters for three-phase mains. The LC display with background lighting allows for reliable readings with no glare to be made even from long distance. A clear user interface and direct display of the functions used for all measurements are characteristic of the instrument. With integrated active and reactive power meters.

Features:

- USB interface
- Compatible with CASSY Lab 524220 software for recording and evaluation of measured data
- Integrated kWh active power meter, kWh reactive energy meter and counter for operating time in hours
- Min/max memory for all relevant measured values
- Simultaneous display of 3 measuring values and energy operating hours
- Display of the mean current and of the mean maximum current (bimetallic/friction pointer function)
- Selectable integration time
- All measuring values with direct dimension display
- Two overload outputs or freely selectable
- One pulse output/one overload output
- Overload monitoring functions of all measuring values, freely selectable pulse output for active power
- Analogue output 0/4-20 mA or 0/2-10 V
- Direct input, 3 x 30 A AC
- Mains connection 230 V AC

Technical data:

Measurement quantities:

- Voltage: $V, V_{\min}, V_{L-N}, V_{L-L}$ 3 x 23...475 V AC
- Current: $I, I_{\min}, I_{\max}, I_{L1/L2/L3}$ up to 3 x 10 A AC
- Active power: $P, P_{\min}, P_{\max}, P_s/P_{L1}/P_{L2}/P_{L3}$
- Reactive power: $Q, Q_{\min}, Q_{\max}, Q_s/Q_{L1}/Q_{L2}/Q_{L3}$
- Power factor $\cos \phi, \cos \phi_s/\cos \phi_{L1}/\cos \phi_{L2}/\cos \phi_{L3}$
- Mains frequency: $f_{\text{mains}}, f_{L1}/f_{L2}/f_{L3}$ 45...65 Hz
- Accuracy: 1% of maximum value in measuring range

727 230USB | Multi-functional meter



Moving iron meter, 2.5 A

Robust instrument for current monitoring in continuous use.

Technical data:

- Moving iron galvanometer
- Front frame: 144 x 144 mm
- Class: 1.5
- Measurement ranges: 0 - 2.5 A

727 32 | Moving iron meter, 2.5 A

Complete equipment set DC/AC/EL

Optimised equipment set for carrying out experiments from the following topic groups:

- STE 2.2 DC Technology
- STE 2.3 AC Technology
- STE 6.1.1 Discrete Components and Basic Electronic Circuits

Scope of delivery:

- 1 Resistor, 0.1 Ω , 2 W
- 1 Resistor, 0.22 Ω , 2 W
- 1 Resistor, 1 Ω , 2 W
- 2 Resistors, 10 Ω , 2 W
- 1 Resistor, 47 Ω , 2 W
- 2 Resistors, 100 Ω , 2 W
- 1 Resistor, 150 Ω , 2 W
- 1 Resistor, 220 Ω , 2 W
- 1 Resistor, 330 Ω , 2 W
- 1 Resistor, 470 Ω , 2 W
- 1 Resistor, 1 k Ω , 2 W
- 1 Resistor, 1.5 k Ω , 2 W
- 1 Resistor, 2.2 k Ω , 2 W
- 1 Resistor, 3.3 k Ω , 2 W
- 1 Resistor, 10 k Ω , 0.5 W
- 1 Resistor, 47 k Ω , 0.5 W
- 1 Resistor, 100 k Ω , 0.5 W
- 1 Resistor, 330 k Ω , 0.5 W
- 1 Resistor, 1 M Ω , 0.5 W
- 1 Potentiometer, 220 Ω , 3 W
- 1 Potentiometer, 1 k Ω , 1 W
- 1 Potentiometer, 10 k Ω , 1 W
- 1 Potentiometer, 100 k Ω , 1 W
- 1 VDR resistor
- 1 Photoresistor, LDR 05
- 1 NTC thermistor, 150 Ω , 1 W
- 1 PTC thermistor, 150 Ω , 1 W
- 1 Capacitor, 100 pF, 160 V
- 1 Capacitor, 22 pF, 100 V
- 1 Capacitor, 0.1 μ F, 100 V
- 1 Capacitor 1 μ F, 100 V
- 1 Capacitor 2.2 μ F, 63 V
- 2 Capacitors 4.7 μ F, 63 V
- 1 Capacitor 10 μ F, 35 V
- 1 Capacitor 47 μ F, 40 V
- 1 Capacitor 100 μ F, 35 V
- 2 Capacitors 470 μ F, 16 V
- 1 LED, red, LED 2, light emitted from top
- 1 LED, infrared, light emitted laterally from side)
- 1 LED, green, LED1, from top
- 1 LED, red, from side
- 1 Ge diode, AA 118
- 4 Si diodes, 1N 4007
- 1 Zener diode, ZPD 6.2
- 1 Zener diode, ZPD 9.1
- 1 Diac, BR 100
- 1 Photo-diode, BPX 43
- 1 Transistor, BD 137 (NPN), emitter at bottom
- 1 FET, BF 244
- 2 Thyristors, TYN 1012
- 1 Triac, BT 137/800
- 1 Inductor, 33 mH
- 2 Screw lamp holders E10, point sideways
- 2 Screw lamp holders E10, pointing up
- 2 Push buttons, single-pole
- 2 Change-over switches, single-pole
- 1 Relay with single-pole change-over contact
- 1 Coil, 500 turns
- 1 Coil, 1000 turns
- 1 Transformer core, for assembly and disassembly
- 2 Plug-in battery holder
- 2 Monocell batteries, 1.5 V
- 1 Magnet with core
- 1 Set of 10 incandescent lamps, 4 V/0.16 W, E10
- 1 Set of 10 incandescent lamps 12 V/3 W, E10
- 1 Set of 10 incandescent lamps, 2.5 V/0.25 W, E10
- 1 Set of 10 incandescent, lamps 6 V/3 W, E10
- 1 Glow lamp 110 V, E10
- 2 Trays, STE



727 510N Complete equipment set DC/AC/EL

Standard image, contents may differ



Basic set T 2.4.1, STE

Collection of STE components for „Three-Phase Transformers and Transformer Circuits“.

Scope of delivery:

- 1 E-core assembly kit
- 1 Base for E-core
- 6 Coils, 250 turns
- 3 Coils, 500 turns
- 3 Resistors, 56 ohm, 11 W
- 1 Tray STE

727 514	Basic set T 2.4.1, STE
---------	------------------------

Basic set T 2.4.2, STE

Collection of STE components for „Three-Phase Circuits and Rectifiers“. For experiments involving single/3-phase transformers, phase-shifts, transformer configurations and rectifier circuits: M1, M2, M3, M6, B2 and B6.

Scope of delivery:

- 6 Si-diodes, BY 255
- 1 Resistor, 1 Ω , 2 W
- 1 Resistor, 100 Ω , 2 W
- 1 Resistor, 1 k Ω , 2 W
- 1 Capacitor, 22 μ F, 16 V
- 1 Capacitor, 100 μ F, 35 V
- 1 Capacitor, 1000 μ F, 40 V
- 1 Coil, 10 mH
- 1 Tray, STE

727 515	Basic set T 2.4.2, STE
---------	------------------------

Standard image, contents may differ



Basic set STE 6.1.1

Collection of STE components for „Discrete Components and Basic Electronic Circuits“.

Scope of delivery:

- 1 Resistor, 10 Ω , 2 W
- 1 Resistor, 100 Ω , 2 W
- 1 Resistor, 330 Ω , 2 W
- 1 Resistor, 470 Ω , 2 W
- 1 Resistor, 1 k Ω , 2 W
- 1 Resistor, 1.5 k Ω , 2 W
- 1 Resistor, 2.2 k Ω , 2 W
- 1 Resistor, 3.3 k Ω , 2 W
- 1 Resistor, 10 k Ω , 0.5 W
- 1 Resistor, 47 k Ω , 0.5 W
- 1 Resistor, 100 k Ω , 0.5 W
- 1 Resistor, 1 M Ω , 0.5 W
- 1 Potentiometer, 1 k Ω , 1 W
- 1 Potentiometer, 10 k Ω , 1 W
- 1 Potentiometer, 100 k Ω , 1 W
- 1 Voltage dependent resistor
- 1 Capacitor, 100 pF, 160 V
- 1 Capacitor, 22 nF, 100 V
- 1 Capacitor, 0.1 μ F, 100 V
- 1 Capacitor, 1 μ F, 100 V
- 1 Capacitor, 2.2 μ F, 63 V
- 2 Capacitors, 4.7 μ F, 63 V
- 1 Capacitor, 10 μ F, 35 V
- 1 Capacitor, 47 μ F, 40 V
- 1 Capacitor, 100 μ F, 35 V
- 1 Capacitor, 470 μ F, 16 V
- 1 LED, infrared, sideways emission
- 1 Ge diode, AA 118
- 4 Si diodes, 1N 4007
- 1 Zener diode, ZPD 9.1
- 1 Zener diode, ZPD 6.2
- 1 LED, green, upwards emission, STE 2/19
- 1 LED, green, upwards emission, STE 2/50
- 1 LED, red, sideways emission



- 1 Diac, BR 100
- 1 Photo-diode, BPX 43
- 1 Transistor, BD 137 (NPN), emitter at bottom
- 1 FET, BF 244
- 2 Thyristors, TYN 1012
- 1 Triac, BT 137/800
- 1 Inductor, 33 mH
- 2 Lamp holders, E10, upwards facing
- 1 Push button, single-pole
- 1 Set of 10 incandescent lamps, 12 V/3 W, E10
- 1 Tray, STE

727 531N Basic set STE 6.1.1

Standard image, contents may differ

Supplementary set T 6.1.18

Basic Power Electronics (Supplement to STE 6.1.1).

Scope of delivery:

- 1 Resistor, 10 Ω , 10 W
- 1 Resistor, 100 Ω , 2 W
- 1 Resistor, 220 Ω , 2 W
- 1 Resistor, 680 Ω , 2 W
- 1 Resistor, 1 k Ω , 2 W
- 1 Resistor, 3.3 k Ω , 2 W
- 1 Resistor, 4.7 k Ω , 2 W
- 1 Resistor, 10 k Ω , 0.5 W
- 1 Variable resistor, 47 k Ω , 1 W
- 1 Capacitor, 1 nF, 100 V
- 1 Capacitor, 10 nF, 100 V
- 1 Capacitor, 47 nF, 100 V
- 1 Capacitor, 0.1 μ F, 100 V
- 1 Capacitor, 100 μ F, bipolar
- 2 Zener diodes, ZPY 8.2
- 1 NPN transistor, BD 137, emitter at bottom
- 1 PNP transistor, BD 138, emitter at bottom
- 1 MOSFET, BSV 81
- 1 Diac, MBS 4991
- 1 Thyristor trigger unit, TCA 785
- 1 GTO thyristor, BTW 58
- 1 Pulse width generator
- 2 Pulse isolating transformers, 1:1, 400 mW
- 1 Ignition pulse generator, activated by touch surface
- 1 Push button, (NC), single-pole
- 1 Change-over switch, two-pole
- 1 Coil, 1000 turns
- 1 Incandescent lamp, 24 V/3 W, E10
- 1 Tray, STE

727 657N Supplementary set T 6.1.18

Standard image, contents may differ

Basic machine unit

For mounting of electrical training machines in training panel frames.

Technical data:

- Dimensions: 200 mm x 297 mm
- Terminals: 4 mm sockets (5 x 2 sockets)
- Connector for rotor position sensor: 10-pin terminal strip
- Connector for three-phase generator: 6-pin DIN socket
- Rotor axle: 100 mm, 8 mm \varnothing

727 811 Basic machine unit

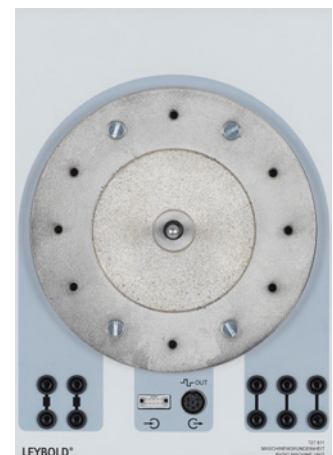

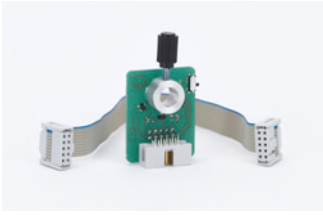

Rotor position pick-up

Electronic device to pick up the position of ELM magnetic rotor (563 19) and ELM 4-pole magnetic rotor (563 191) together with the three phase generator (725 721). The rotor position pick-up is mounted on the basic machine unit (727 811).

727 812 Rotor position pick-up



ELM set: Multipole stator and rotor

Set consisting of:

Stator

Multi-pole stator for attachment to basic machine unit 727811 or 72781. The stator block is fixed to the base by means of screws. Using 4-mm safety sockets, the three phase windings can be connected in either star or delta configuration. Each phase winding is divided into five strands. The phasewindings are easily distinguished by different coil colours.

Rotor

Rotor equipped with 30 surface mounted permanent magnets, 3 of which are combined to one pole. North and south poles are colour-coded. The rotor can be belt-driven using the drive unit 72788.

Technical data:

- Voltage: 12 V
- Current: $I_{max} = 1 \text{ A}$
- Number of poles: 5
- Coil resistance: 2.5Ω

Scope of delivery:

- Multi-pole stator
- Rotor with surface mounted magnets
- 4 fastening screws

727 815 ELM set: Multipole stator and rotor

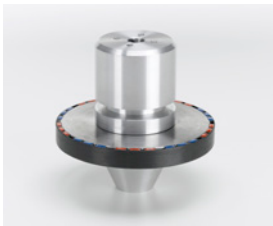

ELM PM magnet rotor with inner magnets

Rotor with 20 inward facing magnets to be used with the stator 727815. Two magnets are combined into one pole, the north and south poles of which are marked with different colours. The rotor can be belt-driven using the drive unit 72788.

727 816 ELM PM magnet rotor with inner magnets

Basic terminal unit

For electrical connection of the assembled machine with meters and load units, with fastening bolts for the masks of the corresponding assembled machines.

727 82 Basic terminal unit

Set of masks

Contains a special mask for each motor or generator type which shows the terminal board with the standardised connections and the symbol of the machine. The mask is hung on the bolts of the basic connection unit.

727 83 Set of masks

Starter

Circular rheostat with scale from 22...0 Ω for starting DC motors.

Technical data:

- Resistance: 22 Ω

727 85 Starter

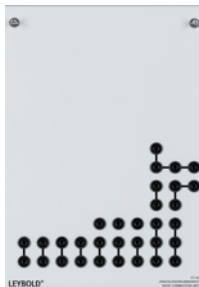
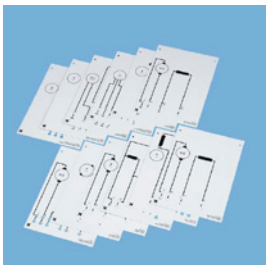

Field regulator

Circular rheostat with scale 47...0 Ω for setting the excitation of DC machines.

Technical data:

- Resistance: 47 Ω

727 86	Field regulator
--------	-----------------



Star-delta load

Plug-in board for assembly of loads for generators with STE plug-in units in star or delta connection.

727 87	Star-delta load
--------	-----------------

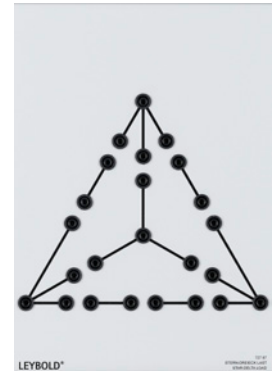

Drive unit

Universal motor with pulley and phase control for continuous speed adjustment from 0 to 3000 rpm. For assembly on the demonstration experiment frame (301 300) or panel frame (726 19).

Technical data:

- Supply voltage: 230 V AC
- Dimensions: 200 mm x 297 mm

727 88	Drive unit
--------	------------

Additionally required:

Count	Cat.-No.	Name
1	685 96	Driving belt, long for drive unit 72788

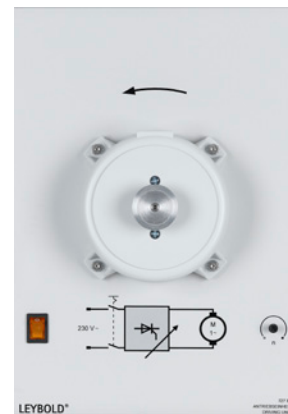

Linear motor basic unit

For use as a track for the linear motor with coil assembly (727 92).

Technical data:

- Length 1500 mm
- Diameter: 16 mm

Scope of delivery:

- 2 training panels with holder for track
- 1 track

727 91	Linear motor basic unit
--------	-------------------------



Linear motor with coil assembly

Carriage with ball bearings and 3 coils, coil terminals with 4-mm safety sockets.

Technical data:

- Voltage: max. 24 V three-phase voltage
- Tractive force: max. 0.8 Nm

727 92	Linear motor with coil assembly
--------	---------------------------------

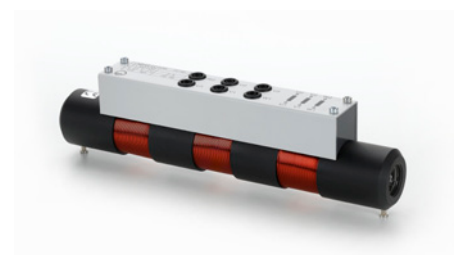

CBC 12.5 Servo technology

Disc with Windows program in German, English and French for the measurement of servo data via the serial interface from the block commutation, sine commutation control units or the digital position controller. The software is also used to control these devices. The program contains two different user interfaces, an extended block circuit diagram corresponding to the connected device with all the appropriate operating data and a time line plotter for the display of voltage, current, speed and position. With this software it is possible to record step responses of the servo drive and to investigate contour errors. Furthermore, four different position reference variables can be stored which are then moved to in sequence (to simulate a process).

Technical data:

System requirements:

- Equipment sets E2.6.2.1, E2.6.2.2 or E2.6.2.3
- Windows XP/Vista/7/8, two free USB-Ports

728 410	CBC 12.5 Servo technology
---------	---------------------------

CBM10 MOMO/FCCP



The CD contains two Windows programs in German and English, one for the recording of characteristics of electrical machines (MOMO) and one (FCCP) for the control of the universal converter 735 297 via the control unit PWM 735 291. School licence.

MOMO: Program for recording the characteristics of DC, AC and three-phase machines in the four quadrants of the speed/torque planes. The measurement values for speed, torque, current, voltage, active power and frequency of the feeding system are transferred via the serial port from the control unit for the pendulum machine to the PC. The display of these measurement variables and the variables derived mathematically from them (apparent power, reactance and mechanical power as well as efficiency and slip), can be evaluated graphically or in tabular form. For three-phase machines the current locus curve can also be depicted and slip can be determined graphically. For this there is a wide range of tools at your disposal. The tables can also be processed further using MS-Excel®.

FCCP: Program for adjusting of the control unit PWM. The following parameters can be set:

- Nominal machine data
- Starting voltage, slip and $I \times R$ compensation
- Ramp time
- Magnetisation current
- Modulation type.

The current voltage/frequency characteristic is displayed in a graphic.

Technical data:

- Windows XP/Vista/7/8, two free USB ports

728 421	CBM10 MOMO/FCCP
---------	-----------------

The software is available for download at www.ld-didactic.com.

Stepper motor

Stepper motor on experiment panel with built-in control logic.

- Operating modes: single-step, half and full-step, clockwise and anti-clockwise rotation
- 64 steps per revolution in half-step mode
- Control: manually via a push button, by means of an external generator or microcomputer, each with TTL level

Technical data:

- Max. control frequency half-step: 800 Hz
- Max. control frequency full-step: 400 Hz
- Inputs and outputs via 4 mm-sockets
- Supply voltage: ± 15 V DC

728 55	Stepper motor
--------	---------------

Lamp sockets E14, set of three

3 built-in E14sockets for incandescent light bulbs, max. 60 W. With 19-mm bridging plugs which can be connected in parallel.

729 09	Lamp sockets E14, set of three
--------	--------------------------------

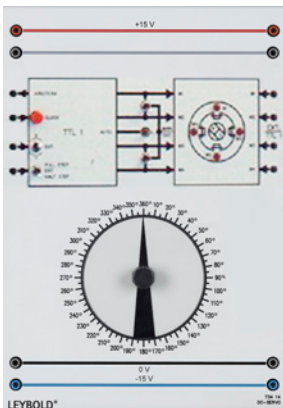

RS-232 cable, 9-pole

RS 232 cable (1:1) with a 9-pin sub-D connector and a 9-pin sub-D socket.

729 769	RS-232 cable, 9-pole
---------	----------------------

Coupling 0.3

Rubber coupling sleeve for mechanical connection of two electrical machines of the 0.1 kW or 0.3 kW series.

731 06	Coupling 0.3
--------	--------------

Shaft end guard 0.3

Attachable guard for protection against contact with electrical machine rotating parts of the 0.1 kW or 0.3 kW series.

731 07	Shaft end guard 0.3
--------	---------------------

Gearbox 0.3

Two-stage planetary gearbox with free-moving motor shaft and drive shaft. Suitable for stepping down high servo speeds (e.g. 6000 rpm) to lower working speeds as well as for increasing the working torque.

Technical data:

- Gear ratio: 36:1
- Constant torque: max. 24 Nm
- Input speed: max. 6000 rpm with CDF (cyclic duration factor) = 10%

731 075	Gearbox 0.3
---------	-------------

Coupling guard 0.3

Attachable guard for protection against contact with electrical machine rotating parts of the 0.1 kW or 0.3 kW series.

731 08	Coupling guard 0.3
--------	--------------------

Coupling guard 0.3 transparent

Attachable guard for protection against contact with electrical machine rotating parts of the 0.1 kW or 0.3 kW series.

731 081	Coupling guard 0.3 transparent
---------	--------------------------------

Linear unit 0.3

Linear guide rail with a ball-and-screw spindle for driving a sled. The sled moves a pointer with a vernier scale along a measuring tape with mm divisions and activates the integrated limit switches (NO contacts) at the left and right ends. The entire linear unit is equipped with a plexiglass hood which serves as protection against it being touched.

Technical data:

- Length: 900 mm
- Travel: 650 mm
- Pitch: 5 mm/rotation
- Reading accuracy: 0.1 mm
- Speed: 3000 rpm max.
- Limit switches: 2 NO contacts
- Contact load: 100 V, 0.1 A DC

731 085	Linear unit 0.3
---------	-----------------

Similar to illustration

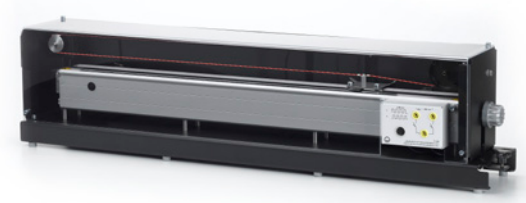

Linear unit with position encoder 0.3



Linear guide rail with a ball-and-screw spindle for driving a sled. The sled moves a pointer with a vernier scale along a measuring tape with mm divisions and activates the integrated limit switches (NO contacts) at the left and right ends. A cord connects the slide to an incremental position encoder which supplies two square-wave signals (A, B) displaced by 90° and a reference pulse (REF). The entire linear unit is equipped with a plexiglass hood which serves as protection against it being touched.

Technical data:

- Length: 900 mm
- Travel: 650 mm
- Pitch: 5 mm/rotation
- Reading accuracy: 0.1 mm
- Speed: 3000 rpm max.
- Limit switches: 2 NO contacts
- Contact load: 100 V, 0.1 A DC
- Incremental position encoder, tracking (A, B): 5 pulses/mm
- Incremental position encoder, REF tracking: 1 pulses/100 mm

Scope of delivery:

- Connecting lead, 6-pole, L = 1.5 m

731 086	Linear unit with position encoder 0.3
---------	---------------------------------------

Potentiometric angle transducer 0.3



Transducer used for measuring the actual angular position of a shaft for the precise positioning of a drive via position servo control. The transducer is equipped with a 360 degree scaled angle disc for visual display of the shaft position.

Technical data:

- Reading accuracy: 1°
- Speed: 200 rpm max.
- Potentiometer: 10 kΩ
- Extent of rotation, mechanical, 360° unlimited
- Extent of rotation, electric, 340°
- Resolution with respect to infinity
- Supply voltage: ±15 V DC

731 089	Potentiometric angle transducer 0.3
---------	-------------------------------------

Tacho generator 0.3



For registering the speed of electrical machines in the 0.1 kW and 0.3 kW series.

Technical data:

- Output voltage: ±1 V/1000 rpm

731 09	Tacho generator 0.3
--------	---------------------

Incremental tacho 0.3



For registering the speed of electrical machines in the 0.1 kW and 0.3 kW power class, as well as for incremental positioning of a servo machine. The TTL-compatible signals, A, B and REF, are accessible via 4-mm sockets. 1024 pulses at A or B correspond to a mechanical angle of rotation of 360 degrees.

The signals A and B are phase-shifted by 90 degrees for the determination of the shaft's rotation direction. The REF pulse is generated once per shaft revolution. The universal speed indicator or the control unit block commutation is needed for the power supply and display.

Technical data:

- Connection: 6-pin DIN socket
- Speed: 10.000 rpm max.
- Increments: 1024 pulses/360°

Scope of delivery:

Contained in Scope of delivery: Connection cable, 6-pole, L = 1.5 m.

731 092	Incremental tacho 0.3
---------	-----------------------

Resolver 0.3

Brushless hollow-shaft resolver for detecting the angular position of a shaft. The resolver serves as a detector for the sine commutation of a permanently excited brushless DC motor as well as for recording the speed and perform positioning in AC servo drives. In order to set the shaft position of the resolver in a definite position with respect to the AC servo motor, the resolver stator can be mechanically adjusted by ± 45 degrees. The resolver is fed with a sinusoidal signal and supplies two signals of equal frequency, but different amplitudes to the output. The amplitudes are dependent on the angular position of the shaft. With one revolution of the shaft, the envelope curves of the amplitudes produce one sinusoidal and one cosine signal of 360° electrical each. From these signals the evaluating electronics in the sine commutation control unit (735 293) determines the absolute position of the shaft.

Technical data:

- Speed: 10.000 rpm max.
- Transformation ratio: 0.5
- Electrical error: $\pm 0.25^\circ$
- The inputs and outputs are each accessible via 4-mm sockets or 6-pin DIN socket
- Supply voltage: 4 V/10 kHz supplied by the sine commutation control unit

Scope of delivery:

- Connection cable 6-pole, L = 1.5 m

731 094	Resolver 0.3
---------	--------------



Commutation pick-up 0.3

For determining the rotor position of a permanently-excited brushless DC motor (AC servo). The pick-up contains three Hall-type switches and a 4-pole pick-up magnet mounted to the shaft. In order to set the shaft position of the commutation pick-up in a definite position with respect to the AC servo motor, the pick-up magnet can be mechanically adjusted by ± 45 degrees. The signals generated during the rotation of the shaft supply the evaluating criteria for the block signal type commutation of a 4-pole AC servo motor.

Technical data:

- Speed: 10.000 rpm max.
- Output voltage: TTL level
- Supply voltage: + 15 V DC supplied by block commutation control unit , cat. no. 735 292

Scope of delivery:

- Connection cable 6-pole, L = 1.5 m

731 096	Commutation pick-up 0.3
---------	-------------------------



Interference suppressor filter 0.3

Two-stage interference suppressor filter with two current-compensated chokes each and two class X and Y capacitors each and one choke connected to the protective earth connector for the disturbance suppression of the universal motor 0.3 and repulsion motor 0.3. The filter is connected between the mains and machine and reduces the machine's output of line-bound disturbance signals in a low-voltage network in accordance with EN 5008-1.

Technical data:

- V = 110/230 V, 47...62 Hz
- $I_N = 6$ A

731 31	Interference suppressor filter 0.3
--------	------------------------------------

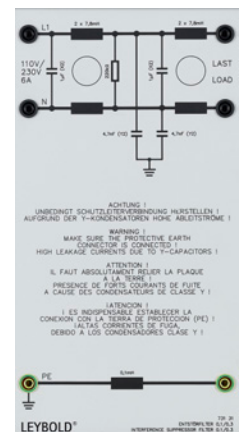

Squirrel cage fault simulator

The fault simulator, in conjunction with asynchronous squirrel-cage motors allows for simulation of typical malfunctions like shorts to ground, winding breaks, turn-to-turn faults, winding-to-frame shorts and tripping of the thermal circuit breaker. The faults are generated by 13 switches arranged behind a locked cover. The fault simulator is an adapter to be attached to the terminal panel of the squirrel cage motor.

731 391	Squirrel cage fault simulator
---------	-------------------------------





On/off switch, three-pole

For switching of three-phase units.

Technical data:

- Switch load: 20 A/500 V AC
- Switch positions: 0 - 1

731 42 On/off switch, three-pole

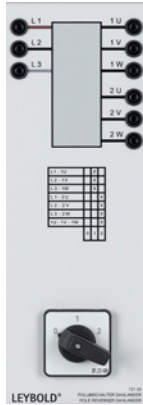

Star-delta switch

To start induction machines.

Technical data:

- Switch load: 20 A / 500 V AC
- Switch positions: 0 - Y - Δ

731 47 Star-delta switch

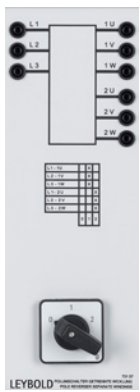

Star-delta reversing switch

To start and to change the direction of rotation of induction machines.

Technical data:

- Switch load: 20 A / 500 V AC
- Switch positions: Δ - Y - 0 - Y - Δ

731 48 Star-delta reversing switch



Reversing switch

To change the direction of rotation of three-phase motors.

Technical data:

- Switch load: 20 A / 500 V AC
- Switch positions: 1 - 0 - 2

731 49 Reversing switch

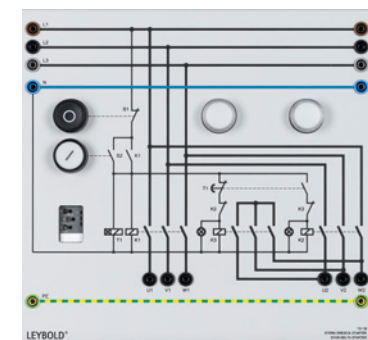

Star-delta starter

Contactor group with time relays for starting three-phase motors of up to approx. 1,5 kW. On/off switching is carried out via two pushbuttons 1 and 0. Automatic switchover from star to delta is carried out after the preset time elapses. The momentary operating status is displayed via two signal lamps.

Technical data:

- Switching capacity: 1,5 kW
- Switchover time delay: 0.3...30 s
- Supply voltage: 3 x 400 V AC

731 50 Star-delta starter



Soft starter 0.3 / 1.0

3-phase soft control device for asynchronous machines with control input and the following setting options:

- Start ramp time
- Start voltage
- Stop ramp time

731 51 Soft starter 0.3 / 1.0

Pole reverser, Dahlander

Switching over the stator windings of special asynchronous machines alters the number of pole pairs and therefore the synchronous speed of the rotating field.

Technical data:

- Switch load: 20 A/500 V AC
- Switch positions: 0 - 1 - 2

731 55 Pole reverser, Dahlander

Pole reverser SW

For switching over the stator windings of asynchronous machines with separate windings.

Technical data:

- Switch load: 20 A/500 V AC
- Switch positions: 0 - 1 - 2

731 57 Pole reverser SW

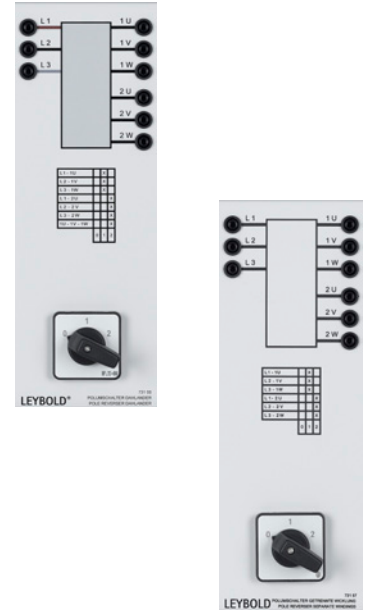

Blocking gear 0.3

Hand operated gear mechanism for setting the rotor of three-phase 0.3 kW asynchronous motors with slip ring rotor when used as a phase shifting transformer.

Technical data:

- $n_2 = 1$
- $n_1 = 20$

731 65 Blocking gear 0.3



DC compound machine 0.3

DC compound machine for motor and generator operation, can be used as shunt, series, or compound wound machine, series winding with tap for compounding and shunt winding. All windings are separately connected to 4 mm safety sockets.

Technical data:

- Power: 0.3 kW
- Voltage: 220 V
- Current: 1.8 A
- Excitation voltage: 220 V
- Excitation current: 0.25 A
- Speed: 2000 rpm

731 86 DC compound machine 0.3



Shunt wound machine 0.3

DC shunt wound machine for motor and generator operation. All windings are separately connected to 4 mm safety sockets.

Technical data:

- Class: 0.3
- Power: 0.3 kW
- Voltage: 220 V
- Current: 1.8 A
- Excitation voltage: 220 V
- Excitation current: 0.25 A
- Speed: 2000 rpm
- International protection code: IP 20
- Insulation system: B/F

731 91 Shunt wound machine 0.3





Series wound machine 0.3

DC series wound machine for motor and generator operation. All windings are separately connected to 4 mm safety sockets.

Technical data:

- Power: 0.3 kW
- Voltage: 220 V
- Current: 1.9 A
- Speed: 2000 rpm

731 92	Series wound machine 0.3
--------	--------------------------



Double wound machine 0.3

DC double wound machine for motor and generator operation. All windings are separately connected to 4-mm safety sockets.

Technical data:

- Power: 0.3 kW
- Voltage: 220 V
- Current: 1.8 A
- Excitation voltage: 220 V
- Excitation current: 0.25 A
- Speed: 2000 rpm

731 93	Double wound machine 0.3
--------	--------------------------

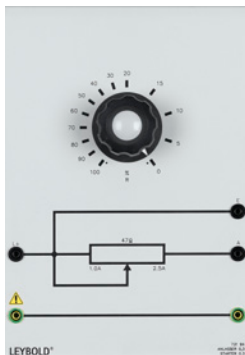

Starter 0.3

Circular rheostat (step winding) with scale (100 - 0%) for starting 0.3 kW DC motors.

Technical data:

- Resistance: 47 Ω
- Current: 2.5 A

731 94	Starter 0.3
--------	-------------

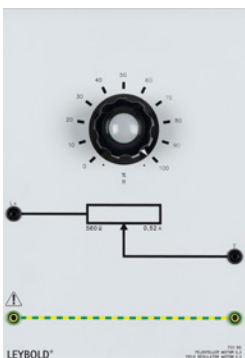

Field regulator, motor 0.3

Circular rheostat with scale (0 - 100%) for adjusting the excitation in 0.3 kW DC shunt and compound wound motors.

Technical data:

- Resistance: 560 Ω
- Current: 0.52 A

731 95	Field regulator, motor 0.3
--------	----------------------------

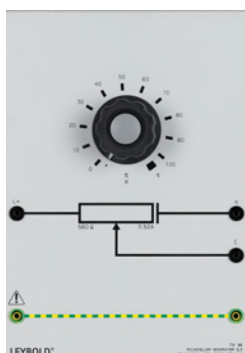

Field regulator, generator 0.3

Circular rheostat with short-circuit contact and scale 0 - 100 % for adjusting the excitation in 0.3 kW DC shunt and compound wound generators.

Technical data:

- Resistance: 560 Ω
- Current: 0.52 A

731 96	Field regulator, generator 0.3
--------	--------------------------------

Machine test system 0.3

Equipment set for recording the characteristics of electrical machines of the 0.3 kW class in all four quadrants, consisting of:

- Cradle-type three-phase asynchronous machine
- Control unit

Cradle-type three-phase asynchronous machine

Squirrel-cage rotor on oscillating bearing with integrated torque pick-up for recording speed, plus stainless steel bending bar with strain gauge for measuring torque. This specially-designed machine can drive any of the machines contained in the electrical machine system 0.3 kW power class and brake any of them down to a standstill. Power is supplied from a control unit via a 7-pole connecting cable with round 7-pin connector, while signals are transmitted via a fixed cable with D-Sub plug connectors.

Control unit

Microcontroller equipped device with integrated frequency converter for the power supply and control of the cradle-type three-phase asynchronous machine. Display of speed and torque of the machine under test. Manual and automatic recording of the characteristics in all four quadrants of the speed/torque plane. Connection to the PC via USB port.

Technical data:

- Automatic digital speed control: ± 5000 rpm
- Automatic digital torque control: ± 9.9 Nm
- Automatic recording of run-up and load characteristics
- Load simulations: flywheel, freely adjustable fan drive ($M \sim kn^2$) freely adjustable winding drive ($M \sim k/n$), lift drive (constant torque)
- Characteristics recorded in accordance with user specifications ($M_i = n_i$)
- External control: ± 10 V
- Seven-segment display, 25 mm high
Speed: 4 digits
Torque: 3 digits
- Parallel operation is possible with the help of the software
- Temperature monitoring:
Machine under test
Cradle type three-phase asynchronous machine
Control unit
- Shaft guard monitoring: system shut-down with protection for unintended system start
- Four quadrant display with LEDs for operating mode of the machine under test
- Adjustable torque limiting (overload protection) and stop speed (for automatic characteristic recording)
- RMS measurement: three inputs for voltage measurement ($V_{max} = 600$ V AC/DC), one input for current measuring ($I_{max} = 10$ A AC/DC), all suitable for frequency converter
- USB connection for transmission of measured values and remote control via software CBM 10
- Highest security standards: leakage current < 5 mA
- Power supply: 230 V, 47 ... 62 Hz, 2 kW

Scope of delivery:

- Mains lead with earth-contact plug
- Demo version of software CBM 10
- USB cable, 3 m
- 25-pole connecting cable
- Supply cable for cradle-type machine
- Dynamometer
- Cylindrical bar

731 989USB	Machine test system 0.3
------------	-------------------------

AC servo motor 0.3

Permanently-excited 4-pole brushless DC motor for use as a direct drive and for implementing highly dynamic positioning and automatic drives in 4-quadrant operation mode.

731 994	AC servo motor 0.3
---------	--------------------





Universal motor 0.3

For operation with AC or DC.

Technical data:

Ratings for connection to AC:

- Power: 0.2 kW
- Voltage: 230 V
- Current: 2.5 A
- Frequency: 50 Hz
- Speed: 3000 rpm

Ratings for connection to DC:

- Power: 0.2 kW
- Voltage: 140 V
- Current: 3 A
- Speed: 3000 rpm

732 00	Universal motor 0.3
--------	---------------------



Repulsion motor 0.3

With adjustable brushes for change of speed and direction.

Technical data:

- Setting range: -2100...0...+2100 rpm
- Power: 0.25 kW
- Voltage: 230 V
- Current: 2.9 A
- Frequency: 50 Hz
- Power factor: 0.69
- Speed: 2100 rpm

732 02	Repulsion motor 0.3
--------	---------------------



Auxiliary phase motor R 0.3

Single-phase AC motor with starting relay and bifilar starter winding.

Technical data:

- Power: 0.2 kW
- Voltage: 230 V
- Current: 2.6 A
- Frequency: 50 Hz
- Power factor: 0.7
- Design: 4-pole
- Speed: 1380 rpm

732 03	Auxiliary phase motor R 0.3
--------	-----------------------------



Capacitor motor R 0.3

Single-phase AC motor with starting relay, starting and operating capacitor. Industrial design with one shaft end.

Technical data:

- Power: 0.37 kW
- Voltage: 230 V
- Current: 2.6 A
- Frequency: 50 Hz
- Power factor: 0.93
- Starting capacitor C_A : 50-63 μ F
- Operating capacitor C_B : 20 μ F
- Design: 4-pole
- Speed: 1400 rpm

732 04	Capacitor motor R 0.3
--------	-----------------------

Auxiliary phase motor F 0.3

Single-phase AC motor with centrifugal switch and bifilar starter winding.

Technical data:

- Power: 0.2 kW
- Voltage: 230 V
- Current: 2.6 A
- Frequency: 50 Hz
- Design: 4-pole
- Speed: 1380 rpm

732 05 Auxiliary phase motor F 0.3



Capacitor motor F 0.3

Single-phase AC motor with centrifugal switch, starting and operating capacitor.

Technical data:

- Power: 0.25 kW
- Voltage: 230 V
- Current: 2.2 A
- Frequency: 50 Hz
- Power factor: 0.85
- Design: 4-pole
- Speed: 1420 rpm

732 06 Capacitor motor F 0.3



Squirrel cage motor 230/400/0.3

Three-phase asynchronous motor with squirrel cage rotor, industrial design with one shaft end.

Technical data:

- Class: 0.3
- Power: 0.25 kW
- Voltage: 400 /230V, Y/ Δ
- Current: 0.76 /1.32 A
- Frequency: 50 Hz
- Power factor: 0.79
- Design: 4-pole
- Speed: 1350 rpm
- International protection code: IP 20
- Insulation system: F

732 104 Squirrel cage motor 230/400/0.3



Squirrel cage motor 400/690/0.3

Three-phase asynchronous motor with squirrel cage rotor and distinct pull-out torque. Industrial design with one shaft end.

Technical data:

- Class: 0.3
- Power: 0.27 kW
- Voltage: 400/690 V, Δ/Y
- Current: 1.0/0.58 A
- Frequency: 50 Hz
- Power factor: 0.7
- Design: 4-pole
- Speed: 1350 rpm

732 11 Squirrel cage motor 400/690/0.3





Squirrel cage motor basic 230/400/0.3

Industrial three-phase asynchronous motor with squirrel cage rotor.

Technical data:

- Power: 0.25 kW
- Voltage: 230/400 V, Δ/Y
- Current: 1.0/0.58 A
- Frequency: 50 Hz
- Design: 4-pole
- Speed: 1445 rpm

732 201	Squirrel cage motor basic 230/400/0.3
---------	---------------------------------------



Squirrel cage motor basic 230/400, brake 0.3

Industrial three phase asynchronous motor with cage rotor, with one shaft extension. With electro-mechanical holding brake, controlled via a rectifier.

Technical data:

- Power: 0.25 kW
- Voltage: 230/400 V, Δ/Y
- Current: 1.0/0.58 A
- Frequency: 50 Hz
- Design: 4-pole
- Speed: 1445 rpm

732 202	Squirrel cage motor basic 230/400, brake 0.3
---------	--

Similar to illustration



Squirrel cage motor basic 400/690/0.3

Industrial three-phase asynchronous motor with squirrel cage rotor, one shaft end.

Technical data:

- Class: 0.3
- Power: 0.25 kW
- Voltage: 400/692 V, Δ/Y
- Current: 1.0/0.58 A
- Frequency: 50 Hz
- Design: 4-pole
- Speed: 1445 rpm

732 203	Squirrel cage motor basic 400/690/0.3
---------	---------------------------------------

Similar to illustration



Capacitor motor CS basic 0.3

Industrial single phase alternating current motor with centrifugal switch, start and operation condenser and one shaft extension end.

Technical data:

- Power: 0.25 kW
- Voltage: 230 V
- Current: 1.0/0.58 A
- Frequency: 50 Hz
- Design: 4-pole
- Speed: 1440 rpm

732 204	Capacitor motor CS basic 0.3
---------	------------------------------

Motor protection switches

Cat.-No.	Designation
732 13	Motor protection switch, 0.6–1 A
732 14	Motor protection switch, 1–1.6 A
732 83	Motor protection switch, 1.6–2.4 A
732 84	Motor protection switch, 2.4–4 A
733 54	Motor protection switch, 6–10 A



Squirrel cage motor D 0.3

Three-phase asynchronous motor with squirrel cage rotor, Dahlander circuit, pole reversible. Industrial design with one shaft end.

Technical data:

- Power: 0.25/0.37 kW
- Voltage: 400 V, Δ/Y -Y
- Current: 1.0/1.1 A
- Frequency: 50 Hz
- Power factor: 0.62/0.75
- Design: 4/2-pole
- Speed: 1400/2800 rpm

732 24 Squirrel cage motor D 0.3



Squirrel cage motor SW 0.3

Three-phase asynchronous motor with squirrel cage rotor, 2 separate windings, pole reversible.

Technical data:

- Power: 0.11/0.20 kW
- Voltage: 400 V, Y/Y
- Current: 0.6/0.7 A
- Frequency: 50 Hz
- Power factor: 0.71/0.72
- Design: 6/2-pole
- Speed: 880/1390 rpm

732 26 Squirrel cage motor SW 0.3



Multi-function machine 0.3

Three-phase multi-function machine, can be used as slip ring motor or as synchronous machine for motor and generator operation.

Technical data:

Operation as asynchronous motor

- Power: 0.27 kW
- Voltage: 230/400 V, Δ/Y
- Current: 1.44/0.83 A
- Frequency: 50 Hz
- Power factor: 0.7
- Design: 4-pole
- Speed: 1360 rpm

Operation as synchronous motor

- Power: 0.27 kW
- Voltage: 230/400 V, Δ/Y
- Current: 0./0.52 A
- Excitation voltage: 20 V
- Excitation current: 4 A
- Frequency: 50 Hz
- Power factor: 1
- Design: 4-pole
- Speed: 1500 rpm

732 28 Multi-function machine 0.3



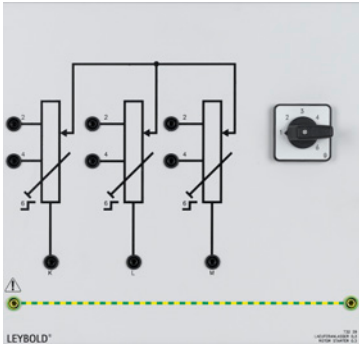

Rotor starter 0.3

Three resistors, synchronously adjustable in 6 steps, for slip ring motors and 0.3 kW multi-function machines.

Technical data:

- Resistance values of switch steps: 20/10/5.5/2.5/1/0 Ω
- Additional fixed taps at: 10/2.5 Ω

732 29	Rotor starter 0.3
--------	-------------------

Slip-ring motor 0.3

Three-phase asynchronous motor with slip ring rotor.

Technical data:

- Power: 0.27 kW
- Voltage: 230/400 V, Δ/Y
- Current: 2/1.16 A
- Frequency: 50 Hz
- Power factor: 0.72
- Design: 4-pole
- Speed: 1340 rpm

732 33	Slip-ring motor 0.3
--------	---------------------



Synchronous machine SP 0.3

Three-phase synchronous machine with salient pole rotor and damper cage for motor and generator operation.

Technical data:

- Power: 0.3 kW
- Voltage: 400 V, Y
- Current: 0.43 A
- Excitation voltage: max.140 V
- Excitation current: max.0.55 A
- Frequency: 50 Hz
- Power factor: 1/0.8
- Design: 4 pole
- Speed: 1500 rpm

732 36	Synchronous machine SP 0.3
--------	----------------------------



Synchronous machine SR 0.3

Three-phase synchronous machine with smooth-core rotor and damper cage for motor and generator operation.

Technical data:

Motor operation

- Power: 0.3 kW
- Voltage: 230/400 V, Δ/Y
- Current: 0.66/1.14 A
- Excitation voltage: max.150 V
- Excitation current: max.0.95 A
- Frequency: 50 Hz
- Power factor: 0.97
- Design: 4-pole
- Speed: 1500 rpm

732 37	Synchronous machine SR 0.3
--------	----------------------------



Resistive load 0.3

Three synchronously adjustable circular rheostats (step winding) with scale (100 - 0%), each with a series resistor and fuse in the sliding-contact connection, suitable for parallel, series, star and delta circuits.

Technical data:

- Resistance: $3 \times 1800 \Omega$
- Series resistance: $3 \times 47 \Omega$
- Current: $3 \times 1 \text{ A}$

732 40 Resistive load 0.3

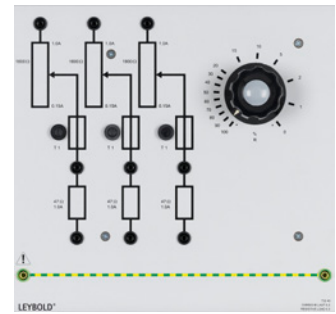

Capacitive load 0.3

Three groups of MP capacitors, each consisting of four capacitors, suitable for parallel, series, star and delta circuits.

Technical data:

Capacitors:

- $3 \times 1/2/4 \mu\text{F}$, 450 V
- $3 \times 8 \mu\text{F}$, 400 V

732 41 Capacitive load 0.3

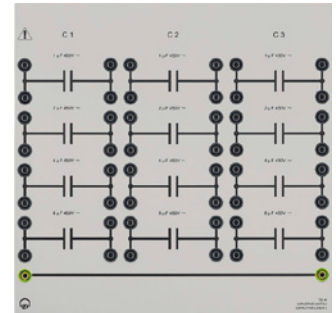

Inductive load 0.3/1.0

Three inductors with taps suitable for parallel, series, star and delta circuits.

Technical data:

Inductors:

- 0.2/0.4/0.6 H (0.65 A)
- 0.8/1.0/1.2 H (0.5 A)
- 2.4/4.8/6.0 H (0.25 A)

732 42 Inductive load 0.3/1.0

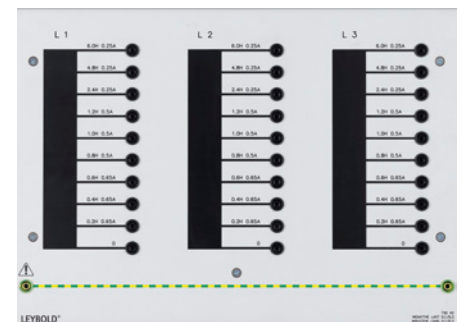

Flywheel 0.3

Suitable for determining friction losses in electrical machines with the aid of run-down experiments. In the case of electrical machines with exciter circuits, the iron and copper losses can also be determined. In the case of two and four quadrant drives, the energy recovery into the mains can be enlarged using the flywheel.

Technical data:

- Class: 0.3
- Speed: max. 3000 rpm
- Inertial torque: 0.006 kg m^2

732 44 Flywheel 0.3



Reluctance motor 0.3

Three-phase synchronous motor without separate excitation.

Technical data:

- Power: 0.25 kW
- Voltage: 380 V Δ
- Current: 1.5 A
- Frequency: 50 Hz
- Power factor: 0.45
- Design: 4-pole
- Speed: 1500 rpm

732 45 Reluctance motor 0.3





Motor with FCC 0.3

FCM 305 industrial frequency converter motor from the DANFOSS FCM 300 series, with 0.55 kW four-pole three-phase asynchronous motor and attached VLT[®] frequency converter. With optimum frequency converter and motor integration performed by the manufacturer. Standard start/stop and jog operating modes with variable speed carried out using the components already integrated into the motor cover.

Technical data:

- PROFIBUS DP/RS 485 compatible.
- Motor output power: 0.55 kW
- Mains voltage range: 3x 380...480 V $\pm 10\%$
- Input current: 1.4 A (380 V), 1.1 A (480 V)
- Mains frequency: 50/60 Hz
- Power factor $\cos \phi$: 0.88/1.0 at nominal load
- Frequency range: 0...132 Hz
- Protection against: excess temperature, phase failure, under and over-voltage, voltage spikes

Socket assignment on the motor cover (4-mm safety sockets with PELV electrical isolation):

- START, JOG, RESET: with respect to internal +24 V, suitable for PLC programmable control.
- ANALOG 1 IN: with respect to internal +10 V, suitable for automatic control applications
- ANALOG 2 IN: 0...20 mA (with respect to the GND socket, measurement current loop input)
- ANA/DIG OUT: 0...20 mA/high-low level
- Mains connection: 4-mm safety sockets L1, L2, L3, PE
- PROFIBUS connection: 9-pin sub-D socket, contact assignment in conforming to EN 50170

Scope of delivery:

- Including technical documentation and software for setting parameters, observing and documenting the frequency converter.

732 46	Motor with FCC 0.3
--------	--------------------



Motor with FCC 1.0

FCM 311 industrial frequency converter motor from the DANFOSS FCM 300 series, with 1.1 kW four-pole three-phase asynchronous motor and attached VLT[®] frequency converter. With optimum frequency converter and motor integration performed by the manufacturer. Standard start/stop and jog operating modes with variable speed carried out using the components already integrated into the motor cover.

Technical data:

- PROFIBUS DP/RS 485 compatible.
- Motor output power: 1.1 kW
- Mains voltage range: 3x 380...480 V $\pm 10\%$
- Input current: 2.5 A (380 V), 2.0 (480 V)
- Mains frequency: 50/60 Hz
- Power factor $\cos \phi$: 0.88/1.0 at nominal load
- Frequency range: 0...132 Hz
- Protection against: excess temperature, phase failure, under and over-voltage, voltage spikes

Socket assignment on the motor cover (4-mm safety sockets with PELV electrical isolation):

- START
- JOG
- RESET: with respect to internal +24 V, suitable for PLC programmable control.
- ANALOG 1 IN: with respect to internal +10 V, suitable for automatic control applications
- ANALOG 2 IN: 0...20 mA (with respect to the GND socket, measurement current loop input)
- ANA/DIG OUT: 0...20 mA/high-low level
- Mains connection: 4-mm safety sockets L1, L2, L3, PE
- PROFIBUS connection: 9-pin sub-D socket, contact assignment in conforming to EN 50170

732 49	Motor with FCC 1.0
--------	--------------------



Coupling 1.0

Rubber coupling sleeve for mechanical connection of two electrical machines of the 1.0 kW series.

732 56	Coupling 1.0
--------	--------------

Shaft end guard 1.0

Attachable guard for protection against contact with electrical machine rotating parts of the 1.0 kW series.

732 57 Shaft end guard 1.0



Coupling guard 1.0

Attachable guard for protection against contact with electrical machine rotating parts of the 1.0 kW series.

732 58 Coupling guard 1.0



DC multi-function machine 1.0

DC multi-function machine for motor and generator operation, can be used as shunt, series, or compound wound machine, series and shunt winding with tap for compounding, with commutating winding and compensation winding. All windings are separately connected to 4 mm safety sockets.

Technical data:

Operation as compound wound motor

- Class: 1.0
- Power: 0.75 kW
- Voltage: 220/135 V
- Current: 4.8/5,8/5,4 A
- Excitation voltage: 220 V
- Excitation current: 0.24 A
- Speed: 2000/1700 rpm
- International protection code: IP 20
- Insulation system: B/F

732 60 DC multi-function machine 1.0

Similar to illustration



Shunt wound machine 1.0

DC shunt wound machine for motor and generator operation, with commutating winding and compensation winding. All windings are separately connected to 4-mm safety sockets.

Technical data:

Motor operation

- Class: 1.0
- Power: 1.0 kW
- Voltage: 220 V
- Current: 6.2 A
- Excitation voltage: 200 V
- Excitation current: 0.25 A
- Speed: 2100 rpm
- International protection code: IP 20
- Insulation system: B/F

732 61 Shunt wound machine 1.0

Similar to illustration



Series wound machine 1.0

DC series wound machine for motor and generator operation, with commutating winding and compensation winding. All windings are separately connected to 4-mm safety sockets.

Technical data:

Motor operation

- Class: 1.0
- Power: 1.0 kW
- Voltage: 220 V
- Current: 6.5 A
- Speed: 2200 rpm
- International protection code: IP 20
- Insulation system: B/F

732 62 Series wound machine 1.0

Similar to illustration



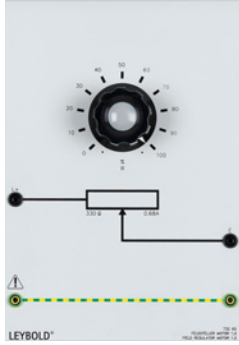
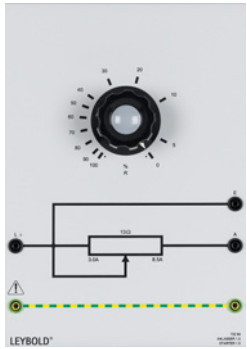

Starter 1.0

Circular rheostat (step winding) with scale 100 - 0 % for starting DC motors 1.0 kW.

Technical data:

- Resistance: 13 Ohm
- Current: 8.5 A

732 64 Starter 1.0

Field regulator, motor 1.0

Circular rheostat with scale 0 - 100 % for adjusting the excitation in DC shunt and compound wound motors 1.0 kW.

Technical data:

- Resistance: 330 Ohm
- Current: 0.68 A

732 65 Field regulator, motor 1.0

Machine test system 1.0

Equipment set for recording the characteristics of electrical machines of the 1 kW class, consisting of:

- Cradle-type three-phase asynchronous machine
- Control unit

Cradle-type three-phase asynchronous machine

Squirrel-cage rotor on oscillating bearing with integrated torque pick-up for recording speed, plus stainless steel bending bar with strain gauge for measuring torque. This specially-designed machine can drive any of the machines contained in the electrical machine system 1.0 kW power class and brake any of them down to a standstill. Power is supplied from a control unit via a 7-pole connecting cable with round 7-pin connector, while signals are transmitted via a fixed cable with D-Sub plug connectors.

Control unit

Microcontroller equipped device with integrated frequency converter for the power supply and control of the cradle-type three-phase asynchronous machine. Display of speed and torque of the machine under test. Manual and automatic recording of the characteristics in all four quadrants of the speed/torque plane. Connection to the PC via USB port.

Technical data:

- Automatic digital speed control: ± 5000 rpm
- Automatic digital torque control: ± 19.9 Nm
- Automatic recording of run-up and load characteristics
- Load simulations: flywheel, freely adjustable fan drive ($M \sim kn^2$) freely adjustable winding drive ($M \sim k/n$), lift drive (constant torque)
- Characteristics recorded in accordance with user specifications ($M_i = n_i$)
- External control: ± 10 V
- Seven-segment display, 25 mm high
 - Speed: 4 digits
 - Torque: 3 digits
- Parallel operation is possible with the help of the software
- Temperature monitoring:
 - Machine under test
 - Cradle-type three-phase asynchronous machine
 - Control unit
- Shaft guard monitoring: system shut-down with protection for unintended system start
- Four quadrant display with LEDs for operating mode of the machine under test
- Adjustable torque limiting (overload protection) and stop speed (for automatic characteristic recording)
- RMS measurement: three inputs for voltage measurement ($V_{max} = 600$ V AC/DC), one input for current measuring ($I_{max} = 15$ A AC/DC), all suitable for frequency converter
- USB connection for transmission of measured values and remote control via software CBM 10
- Highest security standards: leakage current < 5 mA
- Power supply: 230 V, 47 ... 62 Hz, 2 kW

Scope of delivery:

- Mains lead with earth-contact plug
- Demo version of software CBM 10
- USB cable, 3 m
- 25-pole connecting cable
- Supply cable for cradle-type machine
- Dynamometer
- Cylindrical bar

732 689USB Machine test system 1.0



Universal motor 1.0

For operation with 230 V AC or DC.

Technical data:

- Class: 1.0
- International protection code: IP 20
- Insulation system: B/F

Ratings for connection to AC:

- Power: 0.75 kW
- Voltage: 230 V
- Current: 5.2 A
- Frequency: 50 Hz
- Power factor: 0.78
- Speed: 2650 rpm

Ratings for connection to DC:

- Power: 0.8 kW
- Voltage: 220 V
- Current: 5.2 A
- Speed: 2650 rpm

732 70 Universal motor 1.0

Similar to illustration



Interference suppressor filter 1.0

Two-stage interference suppressor filter with two current-compensated chokes each and two class X and Y capacitors each for the disturbance suppression of the 1.0 kW universal motor and 1.0 kW repulsion motor. The filter is connected between the mains and machine and reduces the machine's output of line-bound disturbance signals in a low-voltage network in accordance with EN 5008-1.

Technical data:

- $V = 110/250 \text{ V}, 50/60 \text{ Hz}$
- $I_N = 10 \text{ A}$

732 71 Interference suppressor filter 1.0

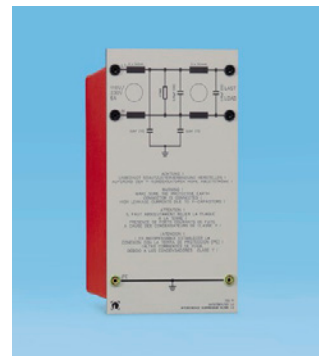

Repulsion motor 1.0

With adjustable brushes for change of speed and direction.

Technical data:

- Class: 1.0
- Setting range: $-2900 \dots 0 \dots +2900 \text{ rpm}$
- Power: 1.0 kW
- Voltage: 230 V
- Current: 10.2 A
- Frequency: 50 Hz
- Power factor: 0.65
- Speed: 2900 rpm
- International protection code: IP 20
- Insulation system: B/F

732 72 Repulsion motor 1.0

Similar to illustration



Auxiliary phase motor R 1.0

Single-phase AC motor with starting relay and bifilar starter winding.

Technical data:

- Power: 0.75 kW
- Voltage: 220 V
- Current: 5.8 A
- Frequency: 50 Hz
- Power factor: 0.81
- Design: 2-pole
- Speed: 2870 rpm

732 73 Auxiliary phase motor R 1.0

Similar to illustration





Capacitor motor R 1.0

Single-phase AC motor with starting relay, starting and operating capacitor.

Technical data:

- Power: 1.0 kW
- Voltage: 230 V
- Current: 6.4 A
- Frequency: 50 Hz
- Power factor: 0.99
- Design: 2-pole
- Speed: 2790 rpm

732 74	Capacitor motor R 1.0
--------	-----------------------

Similar to illustration



Capacitor motor F 1.0

Single-phase AC motor with centrifugal switch, starting and operating capacitor. Industrial design with one shaft end.

Technical data:

- Class: 1.0
- Power: 1.1 kW
- Voltage: 230 V
- Current: 6.6 A
- Frequency: 50 Hz
- Power factor: 0.98
- Starting capacitor: $C_A = 80 \mu\text{F}$
- Operating capacitor $C_B = 30 \mu\text{F}$
- Design: 4-pole
- Speed: 1400 rpm
- International protection code: IP 20
- Insulation system: F

732 76	Capacitor motor F 1.0
--------	-----------------------



Squirrel cage motor 230/400 1.0

Three-phase asynchronous motor with squirrel cage rotor, industrial design with one shaft end.

Technical data:

- Class: 1.0
- Power: 1.0 kW
- Voltage: 230/400 V, Δ/Y
- Current: 4.6/2.7 A
- Frequency: 50 Hz
- Power factor: 0.83
- Design: 4-pole
- Speed: 1410 rpm
- International protection code: IP 20
- Insulation system: F

732 804	Squirrel cage motor 230/400 1.0
---------	---------------------------------

Similar to illustration



Squirrel cage motor 400/690 1.0

Three-phase asynchronous motor with squirrel cage rotor and distinct pull-out torque.

Technical data:

- Class: 1.0
- Power: 1 kW
- Voltage: 400/690 V, Δ/Y
- Current: 2.5/1.44 A
- Frequency: 50 Hz
- Power factor: 0.79
- Design: 4-pole
- Speed: 1405 rpm
- International protection code: IP 20
- Insulation system: B

732 81	Squirrel cage motor 400/690 1.0
--------	---------------------------------

Similar to illustration

Squirrel cage motor D 1.0

Three-phase asynchronous motor with squirrel cage rotor, Dahlander circuit, pole reversible. Industrial design with one shaft end.

Technical data:

- Power: 0.75/1.1 kW
- Voltage: 400 V, Δ/Y -Y
- Current: 1.8/2.7 A
- Frequency: 50 Hz
- Power factor: 0.8/0.84
- Design: 4/2 pole
- Speed: 1425/2850rpm

732 94 Squirrel cage motor D 1.0

Similar to illustration



Squirrel cage motor SW 1.0

Three-phase asynchronous motor with squirrel cage rotor, 2 separate windings, pole reversible. Industrial design with one shaft end.

Technical data:

- Power: 0.4/1.0 kW
- Voltage: 400 V, Y/Y
- Current: 1.6/3.1 A
- Frequency: 50 Hz
- Power factor: 0.64/0.76
- Design: 6/2-pole
- Speed: 930/2870 rpm

732 96 Squirrel cage motor SW 1.0

Similar to illustration



Multi-function machine 1.0

Three-phase multi-function machine with slip ring rotor can be used as induction machine or as synchronous machine for motor and generator operation.

Technical data:

- Class: 1.0
- International protection code: IP 20
- Insulation system: B/F

Ratings for operation as slip ring motor:

- Power: 0.8 kW
- Voltage: 230/400 V, Δ/Y
- Current: 3.5/2.0 A
- Frequency: 50 Hz
- Power factor: 0.75
- Design: 4-pole
- Speed: 1400 rpm

Ratings for operation as synchronous motor:

- Power: 0.8 kW
- Voltage: 230/400 V, Δ/Y
- Current: 2.6/1.5 A
- Excitation voltage: 24 V
- Excitation current: 11 A
- Frequency: 50 Hz
- Power factor: 1.0
- Design: 4-pole
- Speed: 1500 rpm

732 98 Multi-function machine 1.0

Similar to illustration



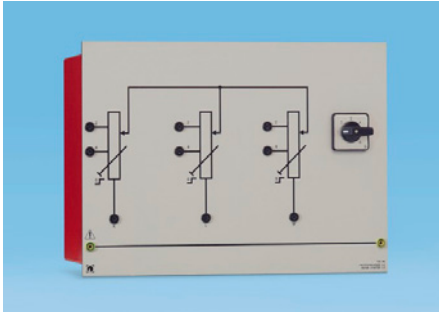

Rotor starter 1.0

Three resistors, synchronously adjustable in 6 steps, for slip ring motor and 1.0 kW multi-function machine.

Technical data:

- Resistance values of switch steps: 10/5/2.75/1.25/0.5/0 Ω
- Additional fixed taps at: 5/1.25 Ω

732 99	Rotor starter 1.0
--------	-------------------

Slip-ring motor 1.0

Three-phase asynchronous motor with slip ring rotor.

Technical data:

- Class: 1.0
- Power: 1.0 kW
- Voltage: 230/400 V, Δ/Y
- Current: 4.8/2.8 A
- Frequency: 50 Hz
- Power factor: 0.71
- Design: 4-pole
- Speed: 1420 rpm
- International protection code: IP 20
- Insulation system: B/F

733 03	Slip-ring motor 1.0
--------	---------------------

Similar to illustration



Synchronous machine SP 1.0

Three-phase synchronous machine with salient pole rotor and damper cage for motor and generator operation.

Technical data:

Ratings for motor operation

- Class: 1.0
- Power: 1.0 kVA / 0.8 kW
- Voltage: 400 V, Y
- Current: 1.52 A
- Excitation voltage: max. 220 V
- Excitation current: max. 0.6 A
- Frequency: 50 Hz
- Power factor: 0.8-1-0.8
- Design: 4-pole
- Speed: 1500 rpm
- International protection code: IP 20
- Insulation system: B/F

733 06	Synchronous machine SP 1.0
--------	----------------------------

Similar to illustration



Synchronous machine SC 1.0

Three-phase synchronous machine with smooth core rotor and damper cage for motor and generator operation.

Technical data:

Ratings for motor operation

- Class: 1.0
- Power: 0.8 kVA / 0.8 kW
- Voltage: 230/400 V, Δ/Y
- Current: 2.66/1.52 A
- Excitation voltage: max. 220 V
- Excitation current: max. 1.6 A
- Frequency: 50 Hz
- Power factor: 0.8-1-0.8
- Design: 4-pole
- Speed: 1500 rpm
- International protection code: IP 20
- Insulation system: B/F

733 07	Synchronous machine SC 1.0
--------	----------------------------

Similar to illustration



Resistive load 1.0

Three synchronously adjustable circular rheostats (step winding) with scale (100 - 0%), each with a series resistor and fuse in the sliding-contact connection, suitable for parallel, series, star and delta circuits.

Technical data:

- Resistance: 3 x 1000 Ω
- Series resistance: 3 x 22 Ω
- Current: 3 x 2.5 A

733 10 Resistive load 1.0

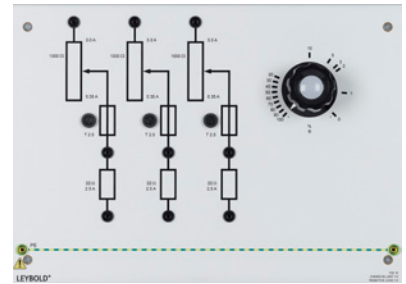

Capacitive load 1.0

Three groups of MP capacitors, each consisting of four capacitors, suitable for parallel, series, star and delta circuits.

Technical data:

- Capacitances:
3 x 2/4 μF, 450 V
3 x 8/16 μF, 400 V

733 11 Capacitive load 1.0

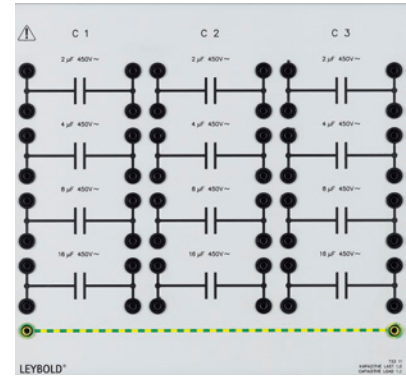

Flywheel 1.0

Suitable for determining friction losses in electrical machines with the aid of run-down experiments. In the case of electrical machines with exciter circuits, the iron and copper losses can also be determined. In the case of two and four quadrant drives, the energy regenerating into the mains can be prolonged using the flywheel.

Technical data:

- Class: 1.0
- Speed: max. 3000 rpm
- Inertial torque: 0.03 kg m²

733 14 Flywheel 1.0

Similar to illustration



Three-phase transformer 0.3

Suitable for all circuit configurations. All connections via 4-mm safety sockets.

Technical data:

- Power: 300 VA
- Primary: 3 x 400/230 V, 50 Hz
- Secondary: 3 x 2 x 115 V

733 90 Three-phase transformer 0.3

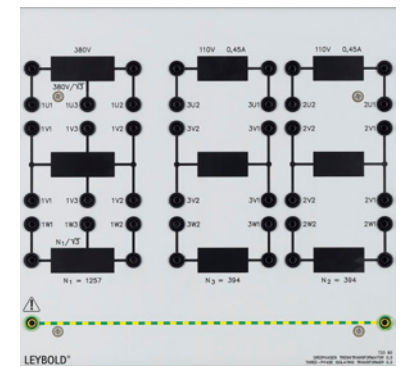

Three-phase transformer 1.0

Suitable for all circuit configurations. All connections via 4-mm safety sockets.

Technical data:

- Power: 1000 VA
- Primary: 3 x 400/230 V, 50 Hz
- Secondary: 3 x 2 x 115 V

733 91 Three-phase transformer 1.0



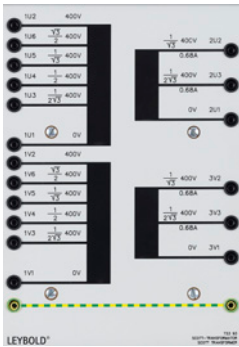

Scott transformer

For transforming from a two-phase to a three-phase mains and vice-versa using a Scott circuit. It can also be used as a three-phase isolating transformer for transformation of 3 x 115/230/400 V into 3 x 115/230 V and vice-versa.

Technical data:

- All connections via 4-mm safety sockets
- Power: 2 x 150 VA
- Primary: 2 x 115/200/230/346/400 V, 50 Hz
- Secondary: 2 x 115/230 V

733 93 Scott transformer

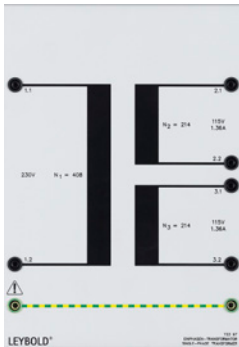

Single-phase transformer 0.3

All connections via 4-mm safety sockets.

Technical data:

- Power: 300 VA
- Primary: 230 V, 50/60 Hz
- Secondary: 2 x 115 V

733 97 Single-phase transformer 0.3

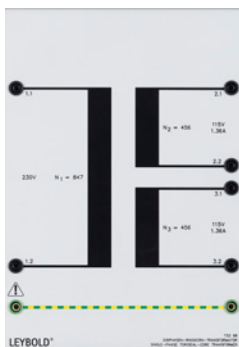

AC toroidal core transformer 0.3

All connections via 4-mm safety sockets.

Technical data:

- Power: 300 VA
- Primary: 230 V, 50 Hz
- Secondary: 2 x 115 V

733 98 AC toroidal core transformer 0.3

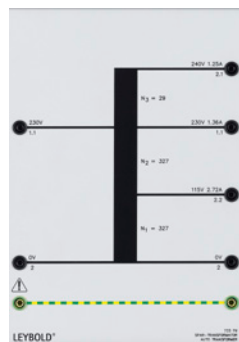

AC autotransformer 0.3

All connections via 4-mm safety sockets.

Technical data:

- Power: 300 VA
- Primary: 230 V, 50 Hz
- Secondary: 115/230/240 V

733 99 AC autotransformer 0.3



Reference variable generator

For the generation of a setpoint value, with linear division of the reference variable potentiometer.

Technical data:

- Output: 0...+10 V can be reconnected to -10...+10 V using bridging plug.
- Output can be switched over to an external reference voltage V_{REF} with the toggle switch or to 0 V using a bridging plug.
- Supply voltage: ± 15 V DC

734 02 Reference variable generator

PID digital controller

Standard industrial compact controller with fast microprocessor support for use as P, PI, PD or PID controller for continuous closed-loop control systems. With input summing point for two reference variables and one controlled variable, measurement point for error signal, tendency indication of the error signal with 3 LEDs, I and D elements can be switched off individually, I element can be reset via separate input (I_{OFF}). Including output summing point for adding or subtracting operations of disturbance variables. Manual selection of controller parameters with buttons and digital encoders. Representation of actual parameters on three four-digit 7-segment displays. Overload indication via three colour LED.

Technical data:

- Signal voltage range: $-10\text{ V} \dots +10\text{ V}$
- Sampling interval: $50\ \mu\text{s}$
- Proportional rate K_p : $0.1 \dots 100$
- Correction time T_N : $0.1\ \text{s} \dots 100\ \text{s}$
- Rate time T_V : $0,1\ \text{s} \dots 100\ \text{s}$
- Selection of controller parameters with buttons and digital encoder
- Representation of actual parameters on 7-segment displays
- Overload indication via three-colour LED
- Supply voltage: $\pm 15\text{ V DC}$

734 064 PID digital controller

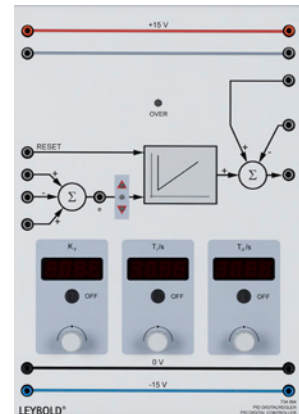

PID digital controller Net

Standard industrial compact controller using 32-bit architecture for integration into the LeyLab network. The internal ARM microprocessor excels in a high sampling rate and a fast control response. The controller is used for continuous closed-loop systems e.g. in P, PI, PD or PID configuration. With input summing point for two reference variables and one controlled variable, measurement point for error signal, tendency indication of the error signal with three LEDs. P, I and D elements can be switched off individually. The I element can be reset via separate input (RESET). Including an output summing point for adding or subtracting of two external and one internal disturbance variables. The internal disturbance variable can be activated via the LAN. Manual selection of controller parameters with buttons and digital encoders. Representation of actual parameters on three four-digit 7-segment displays. Overload indication via three colour LED.

Equipped with a RJ45 socket for LAN operation. Internal control by the software *LEYLAB.control 725006* or *LEYLAB.control Lite 725007* to set and record the controller parameters from a central master PC and to generate disturbances. Suitable for use with patented „Learning networks“ system

Technical data:

- Signal voltage range: $-10\text{ V} \dots +10\text{ V}$
- Sampling interval: $50\ \mu\text{s}$
- Proportional rate K_p : $0.1 \dots 100$
- Correction time T_N : $0.1\ \text{s} \dots 100\ \text{s}$
- Rate time T_V : $0,1\ \text{s} \dots 100\ \text{s}$
- Selection of controller parameters with buttons and digital encoder
- Representation of actual parameters on 7-segment displays
- Overload indication via three-colour LED
- Supply voltage: $\pm 15\text{ V DC}$

734 064N PID digital controller Net

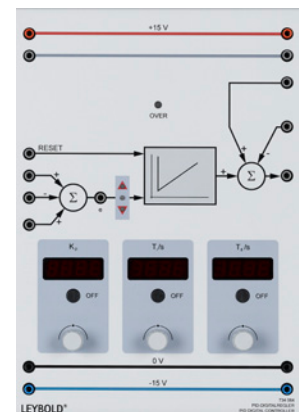

Servo setpoint generator

Position pick-up with rotating angular disc for application in servo systems. With input summing point for forward feeding of disturbance variables or for setpoint variable change and with connectable rate-of-change limiter with rise times of $1\ \text{V/s}$ up to $1000\ \text{V/s}$.

Technical data:

- Signal voltage range: $-10\text{ V} \dots +10\text{ V}$
- Rotating angle:
Mechanical 360° without limit stop
Electrical $340^\circ \pm 5^\circ$
- Fine setting of zero-point and scale factor
- Coarse setting with rotary switch
- Fine setting with potentiometer
- Supply voltage: $\pm 15\text{ V DC}$

734 10 Servo setpoint generator

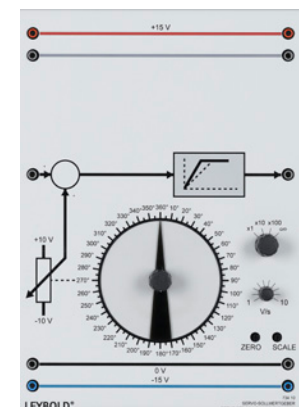

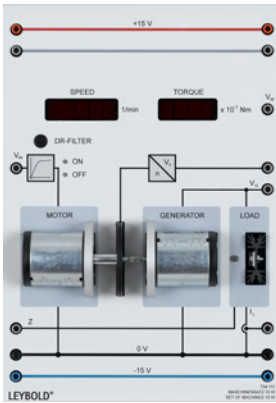

Set of machines 10 W

The set of 10 W machines is a technical controlled system for experiments on speed and voltage control. It consists of an electrical drive including digital speed sensing, a generator machine and an electronic load. Using the adjustable load, real generator operation can be investigated. The machine set makes it possible to measure the load characteristic of the generator and the dynamic behaviour of systems of higher order. A microprocessor controlled power module supplies the drive machine. Thus no external power amplifier is required. The set of machines comes with 7-segment displays for the measurement of speed and torque.

Technical data:

- Speed: 3000 rpm max.
- Control voltage: ± 10 V
- Tachogenerator: ± 10 V
- Switchable prefilter, time constant $T = 800$ ms
- Power consumption: 10 W max.
- Generator efficiency: 40%
- Supply voltage: ± 15 V DC

734 111 Set of machines 10 W

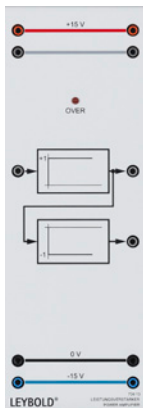

Power amplifier

Used for operating the simulated controlled system models. Two amplifier stages each with a voltage gain of +1 and -1, symmetrical operation possible with voltage gain of 2.

Technical data:

- Signal voltage range: -10 V... $+10$ V
- Output voltage range: -10 V... $+10$ V with respect to earth or symmetrical 0 ... ± 20 V
- Output power: max. 30 W, short-circuit proof
- Supply voltage: ± 15 V DC

734 13 Power amplifier

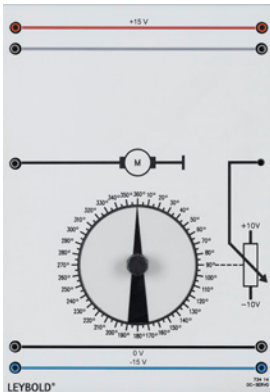

DC servo

Motor potentiometer with 360° mechanical rotation angle without limit, electrical rotation angle $340^\circ \pm 5^\circ$, with DC motor and friction wheel drive, as model of an integral controlled system without compensation with negligible dead time, can also be used in a closed-loop positioning control system.

Technical data:

- Controlled system output signal (controlled variable): -10 V... $+10$ V
- Supply voltage: ± 15 V DC

734 14 DC servo

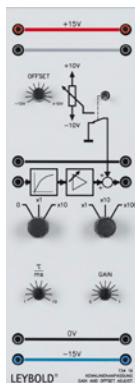

Gain and offset adjust

For the adjustment and matching of external signals to the normal voltage used in automatic control systems.

Technical data:

- Input voltage range: -50 V... $+50$ V
- Level matching via adjustable gain: 0 ... 1 , 0 ... 10 , 0 ... 100
- Smoothing of pulsating signals:
Time constants τ : 0.1 ... 10 ms, 10 ... 100 ms
- Offset voltage, switchable: -10 V... $+10$ V
- Coarse setting via rotary switch
- Fine setting via potentiometer
- Supply voltage: ± 15 V DC

734 19 Gain and offset adjust

Actuator, 115...230 V/1 kW

For the connection of mains-operated DC motors 0.1 kW...1.0 kW. Electrical isolation between the control and the load side.

Technical data:

- Signal voltage range (manipulated variable): 0...+10 V
- Output voltage of the thyristor half-bridge: 0... V_{mains} with a max. load of 1.0 kW
- Built-in automatic circuit-breaker (T 10 A) triggered thermally and for overcurrent
- Output voltage for excitation: $V_{DC} = f(V_{mains})$, max. 10 A
- Outputs: 4-mm safety sockets
- Mains connection for thyristor half-bridge: 115...230 V, 48...62 Hz
- Supply voltage: ± 15 V DC

Scope of delivery:

- Mains lead and earth-contact plug

734 22	Actuator, 115...230 V/1 kW
--------	----------------------------

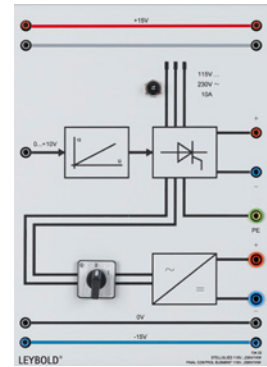

Weight disc with hook

To increase the moment of inertia for cat. no. 73444.

734 36	Weight disc with hook
--------	-----------------------



DC servo with tachogenerator

Motor-potentiometer combination with gear mechanism, control amplifier and angle code disc with toothed belt pinion.

Technical data:

- Control range: 270°
- Linearity: 1%
- Output voltage range: ± 10 V
- Short-circuit proof

734 44	DC servo with tachogenerator
--------	------------------------------

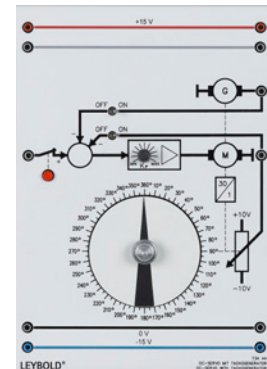

AC servo

Motor-potentiometer combination with gear mechanism, control amplifier and angle code disk with toothed belt pinion.

Technical data:

- Control range: 270°
- Output voltage range: ± 10 V
- Short-circuit proof

734 45	AC servo
--------	----------

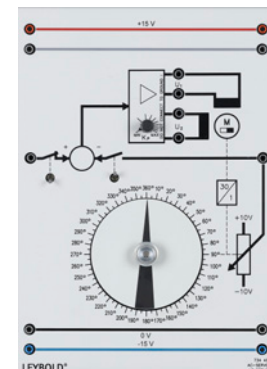

Torque synchro

For use as rotating-field transmitter and receiver („electric waves“).

Technical data:

- 360° system with three-phase output.
- Linearity: 1%
- Switchable 50 V (60 V) AC voltage rotor excitation via built-in mains supply (110 V - 240 V, 50 - 60 Hz)
- Angle code disc with pinion for coupling via toothed belt

734 46	Torque synchro
--------	----------------

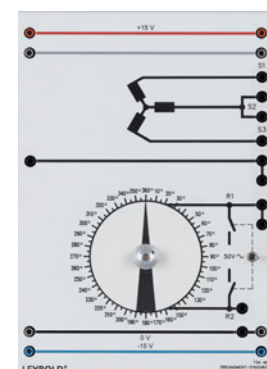



WinFACT COM3LAB/CASSY edition, german

WinFACT (Windows Fuzzy and Control Tools), German version, modularly designed software program for the analysis, synthesis and simulation of conventional automatic control systems. Single user licence. Allows integration of CASSY interfaces, cat. no. 524 013, 524 016 and COM3LAB master unit, cat. no. 700 00USB as processing interfaces.

Technical data:

Contents

- **BORIS** (Block-oriented simulation, 15 blocks):
Control-loop simulation, measurement data acquisition and processing, open-loop and closed-loop control. Endless, single-step and real-time simulation. Comprehensive system block library, exportable project documentation.
- **INGO** (Intelligent Graphic Interface):
Graphic representation of the following WinFACT files:
Simulation results (SIM extension)
General value pairs (XY extension)
Trajectory fields (MXY extension)
Bode plot (BD extension)
Locus curves (OK extension)
3D family of characteristics or height lines (FWM extension)

System requirements

- Windows XP/Vista/7/8, two free USB ports

734 481	WinFACT COM3LAB/CASSY edition, german
---------	---------------------------------------

Phase-commutated converter

Phase-commutated converter consisting of:

- 8 thyristors
- 6 diodes
- 1 triac with optional RC circuitry
- Compact universal converter for all conventional converter circuits, e.g. uncontrolled and controlled rectifiers, inverters, 4-quadrant operation

Control is effected via floating-potential signals transmitted along a 25-pole conductor cable from the converter control unit (735 112).

Technical data:

- Overload protection via fast-blow fuses
- Snubber circuit
- Mains connection: max. 230 V
- Output current: max. 1 A
- Trigger output
- Gate control signals accessible as floating potential signals

Scope of delivery:

Set of 13 overlay masks *phase-commutated converter*

Detection of the applied mask is automatic, thus establishing a preset base state in the converter controller unit (735 122) to prevent the destruction of components through incorrect control commands, thereby simplifying operation of the controller unit. The supplied overlay masks reduce considerable the effort for the experiment set up. Overlay masks do not physically cover necessary connections, they do graphically show the given circuit as a schematic:

- M1/M3, uncontrolled
- M1, controlled
- M3, controlled
- B2, uncontrolled
- B2, controlled
- B2, (un-)controlled for 3 half-waves
- B6, uncontrolled
- B6, controlled
- B6, (un-)controlled for 2 half-waves
- B2, doubled for polarity reversal (B2C)A(B2C)
- W1, anti-parallel 1p
- W3, anti-parallel 3p
- Triac

735 012	Phase-commutated converter
---------	----------------------------

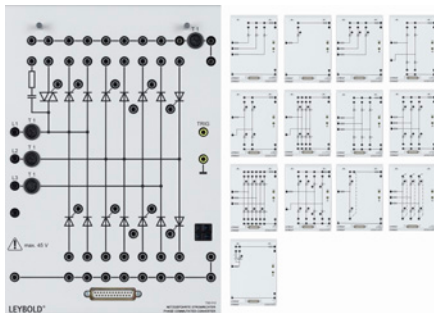

Diode, 1000 V/10 A

Fast-acting silicon rectifier diode with RCD suppressor circuit, which can be switched off, for the assembly of uncontrolled rectifier circuits or use as free-wheeling diode.

Technical data:

- Periodic repetitive peak reverse-bias voltage (V_{RRM}): max. 1000 V
- On-state current (I_{FRMS}): max. 10 A

735 02	Diode, 1000 V/10 A
--------	--------------------

Rectifier B6, 3X400 V/10 A

Uncontrolled mains rectifier in three-phase bridge circuit for the generation of a DC voltage from a three-phase mains. For the generation of link voltages with converters, switched-mode power supplies and in drive technology.

Technical data:

- Nominal voltage ($V_{N RMS}$): 3 x 400 V
- Nominal current (I_{NAV}): 10 A
- Surge forward current (I_{FSM}): 300 A
- I^2t -value: 450 A²s
- Conducting state voltage (V_f): 1 V (per diode)

735 065	Rectifier B6, 3X400 V/10 A
---------	----------------------------

Thyristor branch pair, 1000 V/12 A

Two thyristors with high blocking capacity and RC suppressor circuit for the assembly of line-commutated rectifier and inverter circuits.

Technical data:

- Gate suppressor circuit
- Periodic repetitive peak reverse-bias voltage (V_{RRM}): max. 1000 V
- On-state current (I_{FRMS}): max. 12 A

735 07	Thyristor branch pair, 1000 V/12 A
--------	------------------------------------

Load power electronics

Resistive, inductive and capacitive load for all single-phase and three-phase circuits in power electronics.

Technical data:

- 3 resistors 100 Ω, 1 A, with T 1.25 A fuse
- 1 resistor 1000 Ω, 220 mA
- 2 inductors 50 mH, 2.5 A, with tap at 12.5 mH
- 3 capacitors 4/8/16 μF, 450 V AC

735 09	Load power electronics
--------	------------------------

Capacitors 2x 1000 μF, 385 V

Two electrolytic capacitors which are short-circuit proof and switch-proof. For high performance in all application areas, especially for switched-mode and conventional power supplies or used to form DC voltage link. Built-in reverse voltage protection.

Technical data:

- Nominal capacitance: 2 x 1000 μF
- Nominal voltage: 385 V

735 095	Capacitors 2x 1000 μF, 385 V
---------	------------------------------

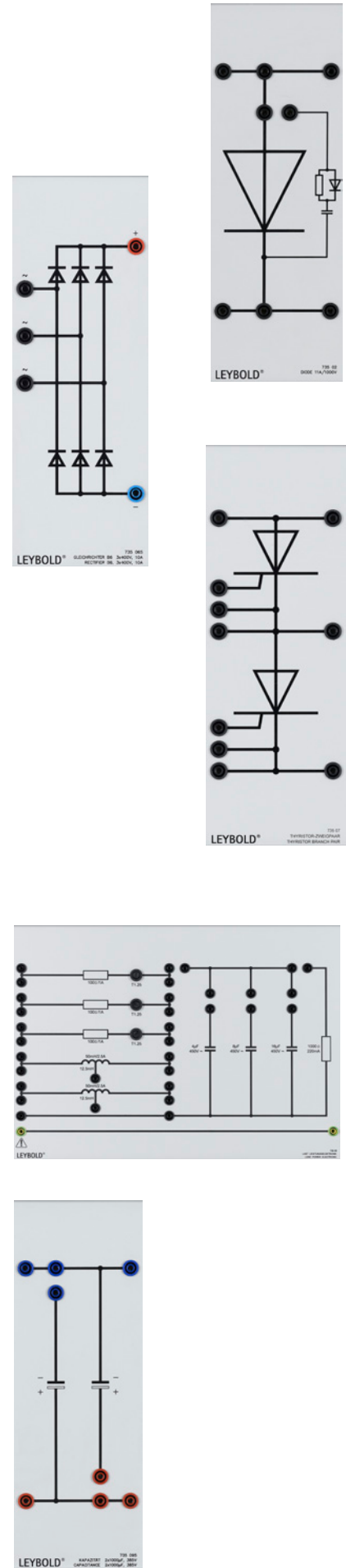

Transformer for SMPS

Power transformer for primary switched-mode power supplies in a forward converter circuit. With the aid of four turn-off converter valves as well as two fast rectifiers, the following primary switched-mode power supplies can be implemented:

- Single-phase forward converter
- Push-pull converter with full-wave rectification
- Asymmetric half-bridge forward converter
- Full-bridge forward converter
- Owing to the shield winding the transformer is suitable for generating a reliable safety extra-low voltage in compliance with VDE 0100 (safety standards). The primary windings are equipped with thermal circuit breakers.

Technical data:

- Primary side:
 - Input voltage (V_{in}): 2 x 115 V
 - Winding: 2 x 48 turns
- Secondary side:
 - Output voltage (V_{out}): 2 x 15 V/4.5 A
 - Winding: 2 x 7 turns
- Nominal power (P_n): 135 VA
- Nominal frequency (f_n): > 15 kHz
- Protective-conductor terminal on the shield winding.

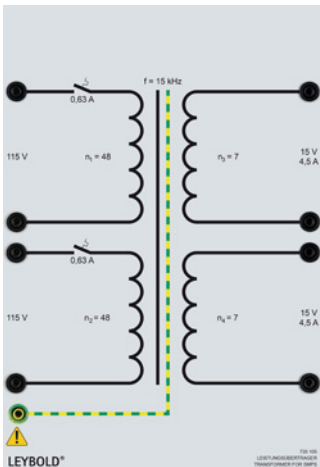

735 105 Transformer for SMPS

Converter controller unit

Microcontroller unit for line-commutated and self-commutated converters for setting up DC, AC and three-phase converters. Operation is performed manually via a selector and keys or via optional PC software.

Operational modes and operations for the line-commutated converter:

- Phase angle control for circuits: M1C, M3C, B2C, W1C, W3C, B6C, triac
- 4-quadrant mode: (B2C)A(B2C)
- Pulse group control (modulation packet control with zero-crossover switch)
- Control angle limitation
- 2 four-digit, 7-segment displays for control angle and three-phase indicator or duty cycle

Operational modes and operations for the self-commutated converter:

- Pulse width modulation
- Produces 3-phase alternating voltages with adjustable amplitude and frequency for the following types of commutation: block, trapezoidal, sine-wave, and VVC
- Single-phase high and low signal generator
- 2 four-digit, 7-segment displays for amplitude and frequency

Technical data:

Connections:

- Analog input for external reference value (control angle, amplitude or frequency)
- USB port
- 25-pole male connector for attaching converter units (including connecting cable)
- Supply voltage via 12 V AC

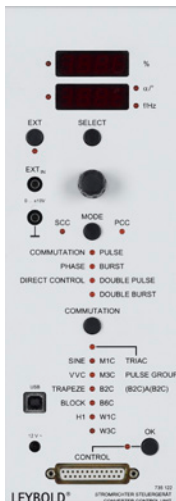

735 122 Converter controller unit

Control unit six pulse, digital

Trigger pulse generator with analog and digital interface (8 bit) for connection to personal computer with CASSY interface in line-commutated, single-phase and three-phase rectifier and inverter circuits, as well as in AC and three-phase controllers.

The matching of the control unit to the converter circuit is carried out using several switches with the following options:

- Single pulse or pulse train operation possible
- Secondary pulse can be switched off (after 60°)
- Phase shift can be set for various natural commutating points: 0°, 30°, 60°

Reliable gate triggering of the valves is guaranteed for even small loads thanks to powerful gate trigger pulses and large voltage-time areas (500 μVs) of the trigger pulse. Rotating field monitoring:

- Green LED when rotating field is clockwise
- Red LED when rotating field is anti-clockwise or for phase-failure

Technical data:

- Signal output for rotating field monitoring (can be OR-operated with the pulse inhibit input)
- 3 x 2 electrically isolated pulse outputs
- Pulse inhibit input
- Synchronising voltage: 1...440 V AC
- Input control voltage: 0...10 V DC for gate control angle 180°...0°
- Digital interface: TTL-level, 8-bit resolution for 180°
- Supply voltage: ±15 V DC

735 135 Control unit six pulse, digital

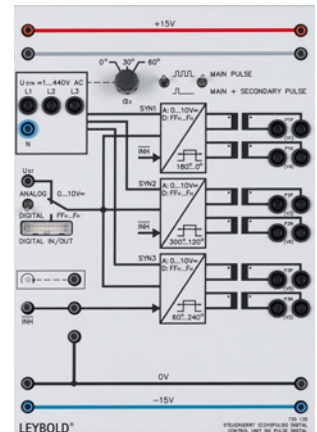

Run-up control unit

For generating a ramp voltage for a reference variable step change at the input.

Technical data:

- Voltage gain: 0.1...1
- Input voltage range: -10 V...+10 V
- Ramp integration time: 0.5...50 s
- Pulse inhibit input
- Supply voltage: ±15 V DC

735 17 Run-up control unit

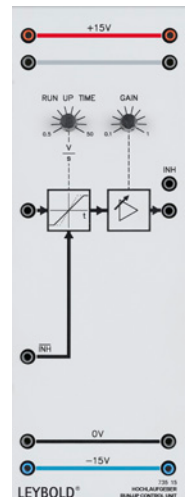

Fuse threefold super-fast

Set of 3 neozed fuses, ultra-rapid for protection of semiconductor valves.

Technical data:

- 3 x 10 A fuses
- 3 x 6 A fuses

735 18 Fuse threefold super-fast

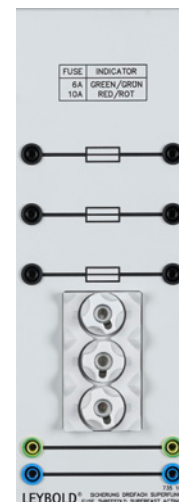

Phase control noise filter 3 x 4.5 A

Single-stage, three-phase interference-suppression filter with high common-mode and normal-mode damping, particularly suitable for experiments in power electronics with self-commutated and line-commutated converter circuits. The filter is connected between the three-phase power supply and the experiment set-up and reduces the output of line-bound interference signals into the low-voltage network in accordance with EN 5008-1.

Technical data:

- 3 toroidal core chokes, 1.3 mH
- 3 X2-class capacitors, 0.47 μF
- 1 Y2-class capacitor, 30 nF
- V = 3 x 230/400 V, 47...63 Hz
- I_N = 3 x 4.5 A

735 190 Phase control noise filter 3 x 4.5 A

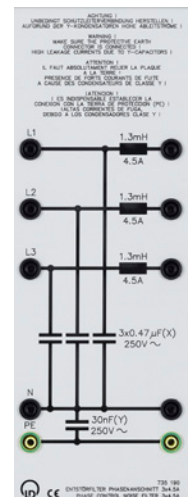

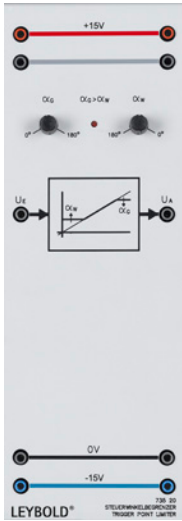

Trigger point limiter

For setting rectifier and inverter stability limits. LED indication for overlap.

Technical data:

- Rectifier stability limit: $0^\circ \dots 180^\circ$
- Inverter stability limit: $180^\circ \dots 0^\circ$
- Supply voltage: ± 15 V DC

735 20 Trigger point limiter

Isolation amplifier, four channel

Four highly linear, cross-talk and noise-immune isolating amplifiers for measurement recording on static converters, drives and frequency converters used in conjunction with an oscilloscope or the CASSY interface. Potential free measurements due to electrical floating inputs. Current measurement is enabled by built-in shunts. A multiplexer allows the four input signals to be displayed on one (storage) oscilloscope. All of the channels can be switched individually and the corresponding zero-line can be displayed on the screen. Position and amplitude can be set separately on the screen for each channel. A space vector indicator with LED display and oscilloscope output permits frequency representation, measurement and evaluation of three-phase systems, particularly in connection with frequency converters and electrical machines. A mathematical module makes it possible to perform addition, subtraction and multiplication of two input signals. An internal filter permits optionally fundamental waves to be reconstructed out of PWM signals.

Technical data:

Isolation amplifier channels A, B, C, E:

- Frequency range: DC...80 kHz
- Voltage: max. 620 V DC/440 V AC
- Attenuator, 3-stage: x1, x0.1, x0.01
- Internal resistance: 1 M Ω
- Accuracy: 2%
- Current: max. 10 A AC/DC; 16 A for $T < 15$ min
- Ranges: 1 V/A and 1/3 V/A
- Internal resistance: 30 m Ω
- Accuracy: 5%
- Overdrive indication via LEDs
- Outputs: 4-mm sockets

Multiplexer:

- Multiplex frequency, adjustable: 50...500 kHz
- Amplitude attenuator: 0.2...1
- Y-position: -8 V...+8 V
- Trigger source: A, B, C, D or E
- Oscilloscope output: 2 BNC sockets

Mathematic module and filter:

- Operating modes for channel D:
 - A+B, A-B, (AxB)/10, AxB, $L_{TM}(A, B, C)$, E
- Low-pass filter, switchable: 1 kHz

Mains connection: 115/230 V, 47...63 Hz

735 261 Isolation amplifier, four channel

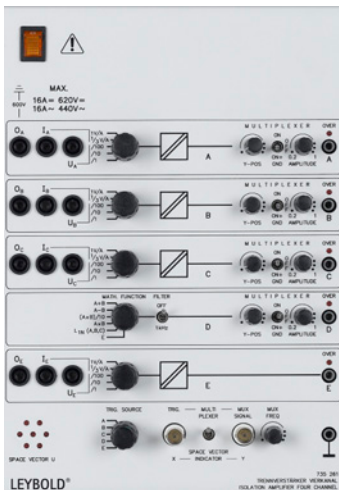

Connecting lead universal converter

25-pole sub-D connecting lead with two plugs, shielded, soft rubber and uncrossed design, length 2 m to connect the COM3LAB Power Electronics Board with the 3 x 230 V universal converter, cat. no 735 297. For use in COM3LAB course PE II, cat. no. 700 22.

735 290 Connecting lead universal converter

Control unit PWM

Control unit with microcontroller for the assembly of a frequency converter in accordance with the PWM characteristic curve method, operated together with the universal converter. A three-phase pulse width modulator controls the six power transistors of the universal converter and thus generates a sinusoidally shaped motor current. The r.m.s. value of the motor voltage is set in accordance with a programmable, dynamically adapting V/f characteristic. The parameters are set via 14 menu items. Indication of the reference/actual value of the current, voltage, or frequency as well as all of the other parameters is handled via a four-digit LED display. Reference variable setting either via external analog interface (-10 V...+10 V) or internal manual input via up/down push-button. Serial interface (RS232) for the communication with a PC for the input of all parameters and the output of measured values. Additional output with 4-mm sockets for the triggering of an oscilloscope. Power supply from the universal converter (735 297) via 25-pin sub-D socket.

Technical data:

Parameters

- Nominal motor data:
 - Power 0.1...1 kW
 - Voltage 0...250 V
 - Current 0...9.9 A
 - Frequency 0...100 Hz
- Limiting data:
 - Current 0...9.9 A
 - Frequency 0...120 Hz
- Ramp time: 0.1...25 s
- Slip compensation: max. 200%
- IxR compensation: 0...99 V/A
- Starting voltage: 0...50 V
- Voltage/frequency ratio: 2...20 V/Hz
- Modulation types:
 - PWM
 - Vector modulation (VVC)
 - Trapezoidal-shaped modulated motor voltage
 - Block-shaped modulated motor voltage

735 291 Control unit PWM

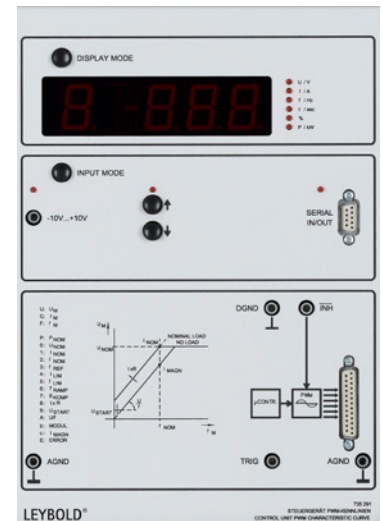

Control unit block commutation

Control unit with microcontroller for the assembly of a highly-dynamic AC servo drive with block signal-shape commutation in operation together with the permanently excited brushless DC machine (AC servo), the universal converter and the commutation pick-up. Alternatively, a 0.3 kW synchronous or multi-function machine can be used. The pulse width modulation is selected so that block-shaped currents are generated in the motor windings. The digital controllers for current, speed and positioning are arranged in cascade configuration. The actual speed value is generated internally out of the commutation signals or measured with an analog or incremental tachogenerator. Commutation signals can also be used for positioning with low resolution (30 degrees). Higher resolution servo positioning is possible by connecting an external servo controller via the parallel interface and an external position pick-up.

Technical data:

- Adjustable limiting data:
 - Current 0...9.9 A
 - Speed 0...9990 rpm
- Indication of the mark-space ratio or the reference/actual value of the current, speed, or position is carried out via four-digit LED display.
- Reference variable setting either via external analog interface (-10 V...+10 V)
- Internal manual input via up/down push-button or parallel interface.
- Serial interface (RS232) for the communication with a PC for the input of desired values and the output of measured values.
- Power supply from the universal converter via 25-pin sub-D socket.

735 292 Control unit block commutation

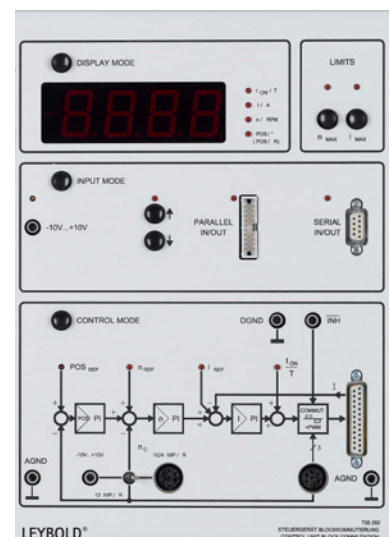

Control unit sine commutation

Control unit with microcontroller for the assembly of highly-dynamic AC servo drives with sinusoidal signal-shaped commutation in operation together with the permanently-excited brushless DC machine (AC servo), the universal converter and the resolver. Alternatively, a 0.3 kW synchronous or a multi-function machine can be used. The pulse width modulation is designed so that sinusoidally shaped currents are generated in the motor windings. The digital controllers for current, speed and positioning are arranged in cascade configuration. The actual speed value is generated internally out of the resolver signals. The resolver permits positioning with high resolution (10 bit/360 degrees, corresponding to 0.35 degrees).

Technical data:

- Adjustable limiting data:
 - Current 0...9.9 A
 - Speed 0...9990 rpm
- Indication of the amplitude factor or the reference/actual value of the current, speed, or position is carried out via four-digit LED display
- Reference variable setting via external analog interface (-10 V...+10 V) or internal manual input via up/down push-button.
- Serial interface (RS232) for the communication with a PC for the input of desired values and the output of measured values.
- Power supply from the universal converter via 25-pin sub-D socket.

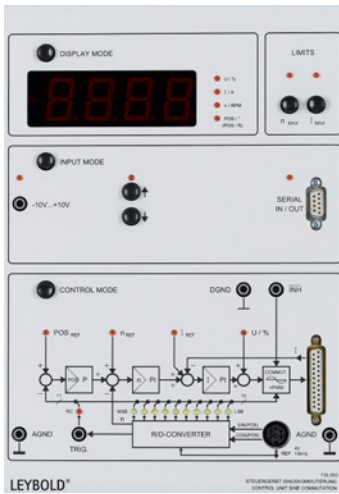

735 293 Control unit sine commutation

Converter input/output

This connection panel enables the student to perform basic experiments with the universal converter, manual control of the power transistors and/or output of all status messages, control signals as well as galvanically isolated actual current values.

Technical data:

Input/outputs (TTL-level):

- PH1/1, PH1/2, PH2/1, PH2/2, PH3/1, PH3/2 for the control of the power transistors via the bridging plugs or TTL-signals, can also be used as measurement output for displaying the control signals on the oscilloscope
- Inhibit, chopper control input, clear
- Status outputs for:
 - Motor temperature
 - Brake chopper signal
 - Converter faults
 - Converter ready signal

Inputs/outputs (analog signals):

- 0...5 V corresponding to the trigger angle 180...0 degrees of the converter/rectifier
- Output for current of phases 1, 2 and 3
- Output current magnitude sum
- Power supply from the universal converter via 25-pin sub-D socket.

Scope of delivery:

- 25-pole connecting cable

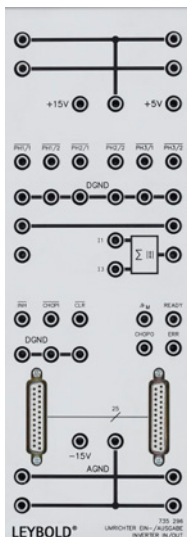

735 296 Converter input/output

Universal converter 3 x 230 V

Transistor pulse converter with voltage link for the generation of a three-phase, frequency and amplitude-variable output voltage from an AC mains. This unit in conjunction with the corresponding control unit is used to assemble a frequency converter or servo amplifier.

Description:

- Single-phase mains connection
- Variable link voltage via fully controllable B2C rectifier bridge circuit
- Three-phase inverter built with IGBT (insulated gate bipolar transistor)
- Maximum operating frequency 20 kHz, resulting in good approximation of sinusoidal current as well as low noise build-up in the machine
- Output short-circuit proof, earth-fault proof and switch proof
- Interface for connection of the control unit (25-pole sub-D socket, TTL level)
- Each individual transistor can be switched on and off via the interface and is protected from damage with an interlocking device
- The respective activated IGBT's are displayed via LEDs
- Monitoring of the variable link voltage, machines and converter excess temperature, excess currents in the rectifier and inverter. Output of the switching status via interface and display via LEDs
- Integrated brake chopper
- Safe separated extra-low voltage (SELV) between the power component and the control unit
- Output currents are detected via Hall generators. Electrically separated output via interface
- 2 stage mains filter for the reduction of the line-bound interference
- 3-phase motor filter for the reduction of the edge steepness of the pulse voltages at the converter output to values < 250 V/μs

Technical data:

- Output voltage (V_{out}): 3 x 0...230 V
- Output current (I_A): max. 3 x 8 A
- Supply voltage: 200...240 V, 50/60 Hz via 4-mm safety sockets

Scope of delivery:

- 25-pole connecting cable

735 297	Universal converter 3 x 230 V
---------	-------------------------------

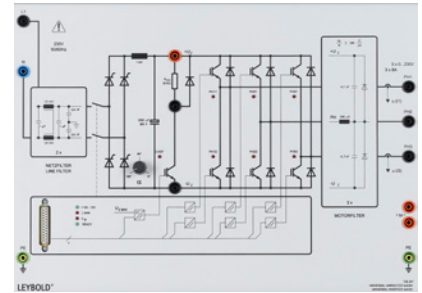

Position controller, digital

The microprocessor-controlled digital position controller, in conjunction with the AC servo drive with block commutation, is used to set up a high-precision single-axis positioning drive. Actual positions can be recorded either with the 0.3 kW incremental speed sensor (731 092), which supplies 1024 pulses per rotation or the 0.3 kW linear unit with a position encoder (731 086), which supplies 5 pulses per 1 mm of travel.

Technical data:

- Six-digit, seven-segment display to indicate positions in increments, rounds or mm.
- Integrated incremental rotary switch to set the position reference variable, controller parameters (K_p) and acceleration ramp.
- Convenient evaluation of the drive's operational data via serial interface (RS 232)
- Reference variables and parameters can then be set via the PC interface.

Scope of delivery:

- 20-pin cable for connection with the control unit block commutation (voltage supply and communication)
- 6-pin connecting lead.

735 299	Position controller, digital
---------	------------------------------



Industrial frequency converter 400 V

Industrial frequency converter for the production of a frequency-variable 3-phase source voltage of max. 400 V/120 Hz with a power rating of 1.5 kW. Operation via keypad or PC, for which a connecting set is included. In addition, an RS 485 port is provided.

735 3101	Industrial frequency converter 400 V
----------	--------------------------------------

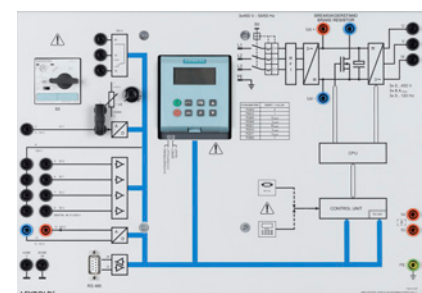

Industrial frequency converter 0.3

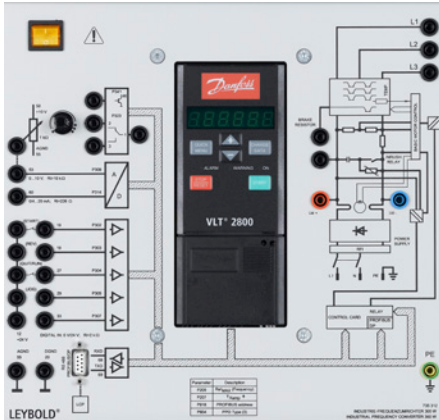

Industrial microprocessor-controlled transistor frequency converter, designed for educational purposes, with voltage link for the generation of three-phase, frequency and amplitude variable output voltage from a single-phase AC mains. This device can be used for open-loop and closed-loop control of all asynchronous machines of the power classes 0.3 kW. Front panel with printed block circuit diagram specially designed to illustrate the various applications/program settings.

Features:

- Inverter control method in accordance with DANFOSS VVC procedure (voltage vector control)
- Programmable, V/f control characteristic capable of adapting dynamically to various different loads
- Programmable, PLC-compatible control inputs
- Analog inputs 0...10 V and 0/4...20 mA
- Programmable control and relay output, status indication via LEDs
- Inputs and outputs are short-circuit proof, earth-fault proof and switch-proof
- Electronic motor protection (with warning signal or automatic switch-off)
- Quality electrical isolation (SELV) between power circuit and control
- Programming and operation performed via key pad, serial interface (PROFIBUS DP) or potentiometer
- Display language can be set to English, German, French or Danish
- Display of all important operating states (e.g. frequency, motor current, voltage, torque) via LED 7 segment display
- Integratable speed controller

Technical data:

- Output current continuous: max. 3 x 2.2 A (3 x 3.5 A max. 60 s)
- Output power continuous: 0.9 kVA
- Output voltage: 3 x 0...133/230 V
- Output frequency: 0.2...132 Hz/1...1000 Hz
- Mains connection: 220...240 V, 50/60 Hz
- Input current: max. 5.9 A

Scope of delivery:

- Including mains connection cable and earth-contact plug
- Including technical documentation and software for setting parameters, observing and documenting the frequency converter.

735 312	Industrial frequency converter 0.3
---------	------------------------------------

LCP2 local control panel



Separate operating unit with display and keyboard (LCP2) for FCM 300, VLT 2800 and VLT 5000, With 1.80 m PROFIBUS DP connection cable.

Technical data:

- Copy function and data memory
- 4-digit display
- Simultaneous display of four current data values
- Attachable or detachable even during VLT operation

735 314	LCP2 local control panel
---------	--------------------------

USB/RS 485 interface converter



For use with industrial frequency converter (735 312) and with the two frequency converter motors (732 46) and (732 49)

Technical data:

- Input: USB 1.1 and USB 2.0 compatible
- Output: 1 RS-485 serial port
- Genuine two-wire read/write operation
- Transfer rate 300 up to 115,200 bps
- Electronic isolation up to 3000 V
- Electricity supply: via USB port
- 9-pin sub-D plugs for RS 485

Scope of delivery:

- Drivers for Windows XP and LINUX

735 315USB	USB/RS 485 interface converter
------------	--------------------------------

Similar to illustration

Thyristor speed control unit

Compact static converter for setting and performing open and closed loop control of DC voltage and current. In addition to making a multitude of experiments possible, it can also be used to control the speed of a shunt wound machine from 0.1 kW to 2.6 kW with cascade current control in 4-quadrant operation.

Technical data:

Features:

- Mains switch and delayed response main contactor for armature and exciter voltages
- Separate fuses, which can be serviced externally, for excitation, the electronic components and three-phase current
- Exciter voltage output: 220 V, 1 A
- Thyristor power circuit with two fully controlled B6 bridges for circulating current-free 4-quadrant operation, nominal data ($V_{LIN} = 90$ V): 0...230 V, 12 A, Indication of the active static converter via 2 LEDs
- Complete electrical isolation between power circuit and control and regulating unit
- Extensive fault monitoring with signalling and switch-off.
- Activation for phase-failure, rotating field fault, machine or equipment overheating and time limit
- Control and regulating electronics with extensive indication, setting and measuring possibilities

Open- and closed-loop control:

- Potentiometer for the setpoint with changeover switch for single quadrant and four quadrant operation
- Run-up integrator with potentiometer for the run-up time: 0.1...100 V/s
- Speed controller with summing point: 2 inverting input and 1 non-inverting input
- Variable gain = 1...10 for actual speed value
Coarse and fine adjustment of the proportional coefficient:
 $K_{PI} = 0.5...5/5...50$
- Coarse and fine adjustment of the reset time: $T_{NI} = 0.1$ s...1 s/1 s...10 s
- I controller can be switched off
- Overdrive indication via LED
- Both converters I and II have a potentiometer for current limitation
 $I_{max I} = 0...12$ A
 $I_{max II} = 0...12$ A
- Instantaneous comparator with adjustable hysteresis
- Absolute-value generator with measurement socket for control signal INVert
- Adaptive current controller with summing point: 2 inverting inputs and 1 non-inverting input
Recognition of intermittent current with LED display and measurement socket for the control signal STL (intermittent current)
Reduction of the reset time to 1/10, when intermittent current is present, can be switched off
Coarse and fine adjustment of the proportional coefficient:
 $K_{PI} = 0.05...0.5/0.25...2.5$
Coarse and fine adjustment of the reset time:
 $T_{NI} = 10$ ms...100 ms/100 ms...1 s
I controller can be switched off -overdrive indication with LED
- Trigger point limiter with the following setting options:
Rectifier stability limit $0^\circ...80^\circ$
Inverter stability limit $180^\circ...100^\circ$
- Switching logic with measurement sockets for the control signals and with a control input STOP
- 4-quadrant indication with 4 LEDs
- Current measurement with current converters
- The control set provides six double-pulse trains which are switched through to the thyristors of the rectifiers I or II via 12 gate pulse transformers

Supply voltage:

- Control unit: 230 V, 50 Hz
- Power circuit: via external three-phase transformer, 3 x 45/90 V, 50 Hz (735 32)

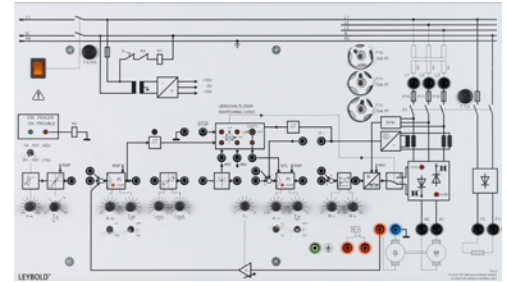

735 32 Thyristor speed control unit

Control unit PWM / PFM

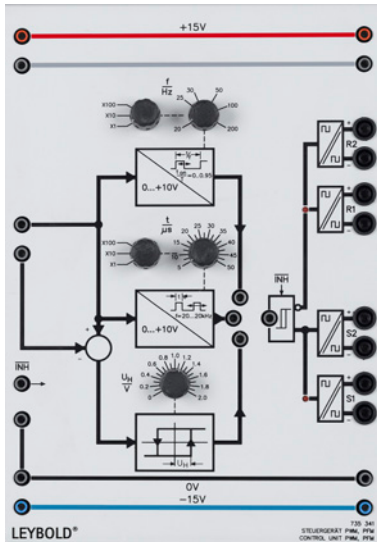

Universal control unit for the assembly of switching DC controllers, switched-mode power supplies and single-phase inverters. It is possible to control all the valves used in power electronics, such as thyristors, GTO thyristors, MOSFETs, Darlingtons transistors and IGBTs with an output amplifier having electrically isolated outputs for triggering and turn-off. Operation can be selected with the following control modes: pulse width modulation (PWM), pulse frequency modulation (PFM) or two-position control.

Technical data:

- Control voltage (all control modes): 0...10 V DC
- Pulse width modulator:
 - Frequency ranges: 20...200 Hz/0.2...2 kHz/2...20 kHz
 - Pulse duty cycle t_{ON} : 0...0.95
- Pulse frequency modulator:
 - Pulse duration ranges: 5...50 μ s/50...500 μ s/0.5...5 ms
 - Frequency: 20 Hz...20 kHz
- Two-position controller:
 - Hysteresis: 0...2 V
- Output amplifier:
 - Sustained short-circuit proof
- Indication of switching state via 2 LEDs
- 2 x 2 electrically isolated outputs (test voltage 3 kV)
- INHIBIT input
- Supply voltage: \pm 15 V DC

735 341 Control unit PWM / PFM

MOSFET 500 V/10 A

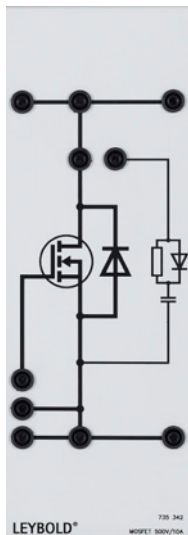

Enhancement-mode n-channel field effect transistor with fast-acting inverse diode (FREDFET) and with RCD protective circuit which can be switched off. For the assembly of DC controllers, switched-mode power supplies of high pulse frequency.

Technical data:

- Drain-source voltage (V_{DS}): 500 V
- Drain DC current (I_D): 10 A
- Drain-source closing resistor ($R_{DS(ON)}$): 0.6 Ω

735 342 MOSFET 500 V/10 A

Thyristor with turn-off circuit 230 V/8 A

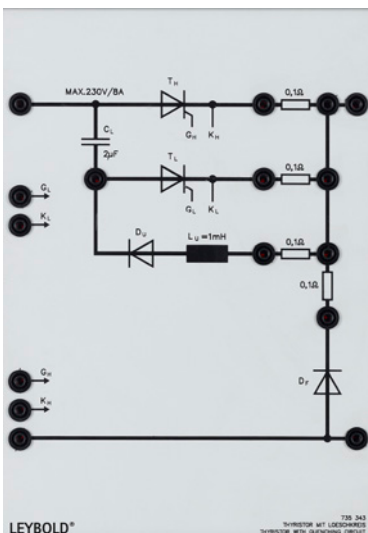

Thyristor which can be turned off with capacitor turn-off and free-wheeling arm. The turn-off circuit consists of ring-around coil with blocking diode, a turn-off thyristor and turn-off capacitor. A DC controller can be implemented directly using the PWM/PPM control unit. Four integrated shunts enable problem-free measurement of the main current, turn-off current, ring-around current and the free-wheeling current. All the thyristors and diodes have a RCD protective circuit.

Technical data:

Main thyristor and turn-off thyristor

- Repetitive peak forward off-state voltage (V_{DRM}): max. 800 V
- On-state current, mean value (I_{TAV}): max. 13 A
- Circuit-commutated recovery time: (t_{cj}): 35 μ s

Free-wheeling diode

- Repetitive peak forward off-state voltage (V_{DRM}): max. 1000 V
- On-state current, mean value (I_{TAV}): max. 8 A
- Shunts: 4 x 0.1 ohms, 1%
- Turn-off capacitor: 4 μ F, 450 V
- Ring-around reactor: 1 mH

735 343 Thyristor with turn-off circuit 230 V/8 A

IGBT 1000 V/10 A

This IGBT (insulated gate bipolar transistor) demonstrates the behaviour of an enhancement-mode field-effect transistor (MOSFET) at the input and the behaviour of a bipolar power transistor at the output. With a fast acting inverse diode and an RCD protective circuit which can be switched off. For use in rapid switching applications with high voltages such as: DC controllers, switch-mode power supplies and inverters.

Technical data:

- Collector-emitter reverse-bias voltage (V_{CES}): max. 1000 V
- Collector current (I_{CAV}): max. 10 A
- Collector-emitter saturation voltage ($V_{CE SAT}$): 3.5 V
- Gate-emitter input capacitance (C_{GE}): 1.8 nF

735 346 IGBT 1000 V/10 A

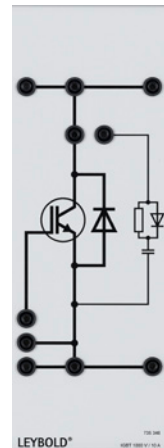

Fault simulator for phase control

Standard dimmer circuit for resistive load ($P = \text{max. } 1.2 \text{ kW}$) with preset minimum value, consisting of triac, diac, 2 potentiometers, resistors and capacitors. Various measurement points permit systematic trouble-shooting. A total of 20 faults from the following categories can be switched on:

- Line break
- Short-circuit
- Faulty assembly
- Faulty components

The faults are switched on using slide switches, which are located behind a lockable cover.

Technical data:

- Supply voltage: 110 V...230 V, 47 Hz...63 Hz

735 390 Fault simulator for phase control

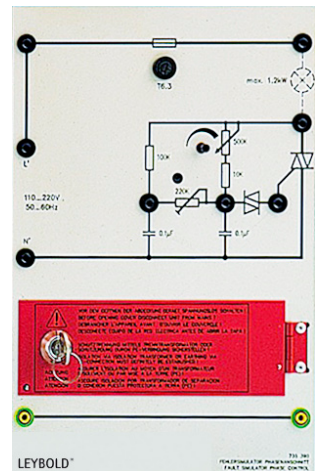

Excitation voltage controller 200 V/2.5 A

Adjustable power supply with smoothed current and voltage for supplying power to a synchronous machine in the power class 0.3 kW or 1.0 kW. Adjustment of the output voltage can be carried out internally using the UP/DOWN push-button or externally via 4-mm sockets using switching contacts, TTL-level or 24 V DC. The setting direction is indicated by two yellow LEDs. When the synchronous machine is run up asynchronously, it is not necessary to short circuit the excitation winding.

Technical data:

- Output voltage V : 0...200 V
- Output current I : max. 2.5 A
- The output is overload-proof and short-circuit-proof.
- Supply voltage: 230 V, 50/60 Hz

745 021 Excitation voltage controller 200 V/2.5 A

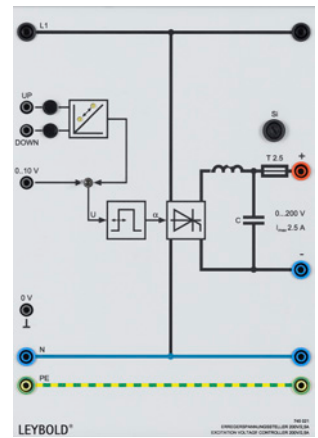

Manual synchronisation unit

Synchronisation unit with manual switch to connect the generator to the mains.

Technical data:

- Two 7-segment voltage displays
- Two 7-segment frequency displays
- One 7-segment zero-volt display
- One optical synchronoscope
- Six synchronisation lamps
- One optical synchronisation indicator
- One rotating field indicator
- One manual three pole switch

745 05 Manual synchronisation unit

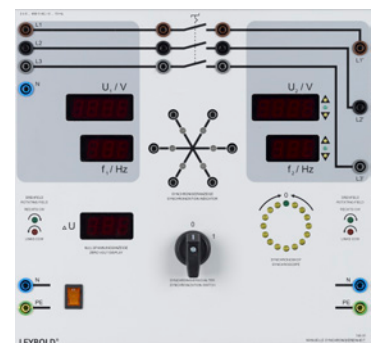

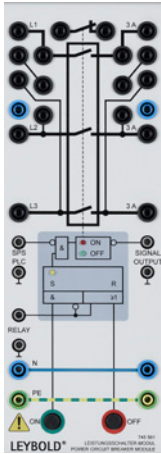

Power circuit breaker module

3-phase ON/OFF switch with auxiliary contact (NC) for 380 kV transmission line model. Can be controlled manually using ON/OFF push-button or externally via switching contact, TTL level or 24 V DC. The switching state is indicated by LED's and is additionally available as TTL level from 4-mm sockets. Control input (switching contact, TTL level, 24 V DC) for external switch-off command (tripping on faults).

Technical data:

- Contact load capacity: 400 V AC, 3 A
- Mains connection: 115/230 V, 50 Hz

745 561	Power circuit breaker module
---------	------------------------------

3-phase stator

Stator for a three-phase machine in the form of a working model demonstrating function, built with drive-end shield and industrial terminal box, electrically functional, mounted on a base socket. The stator is designed to accommodate different rotors. Rotors are attached to the stator by means of star-grip bolts.

Technical data:

- Class: 0.3
- Colour: Machine body, light grey
Base, black

747 720	3 phase stator
---------	----------------



Squirrel cage rotor

Rotor for a three-phase asynchronous machine with pull-out torque in the form of a working model demonstrating function, with non-drive-end shield. The rotor is designed for use with the three-phase stator 747720.

Technical data:

- Class: 0.3
- Cage material: aluminium
- Colour: light grey

747 721	Squirrel cage rotor
---------	---------------------



Slip-ring rotor

Rotor for three-phase asynchronous motor with slip ring rotor in the form of a working model demonstrating function, with non-drive-end shield, fan and dust cover. The slip rings, brush holder as well as the brushes are visible through a perspex cover. The rotor is designed for use with the three-phase stator 747720.

Technical data:

- Class: 0.3
- Colour: light grey

747 722	Slip-ring rotor
---------	-----------------



Salient pole rotor

Rotor for three-phase synchronous machine with salient pole rotor in the form of a working model demonstrating function, with non-drive-end shield, fan and dust cover. The slip rings, brush holder as well as brushes are visible through a perspex cover. The rotor is designed for use with the three-phase stator 747720.

Technical data:

- Class: 0.3
- Colour: light grey

747 723	Salient pole rotor
---------	--------------------



Smooth core rotor

Rotor for three-phase synchronous machine with smooth-core rotor in the form of a working model demonstrating function, with non-drive-end shield, fan and dust cover. The slip rings, brush holder as well as brushes are visible through a perspex cover. The rotor is designed for use with the three-phase stator 747720.

Technical data:

- Class: 0.3
- Colour: light grey

747 724	Smooth core rotor
---------	-------------------

Reluctance rotor

Rotor for three-phase synchronous machine with reluctance rotor in the form of a working model demonstrating function, with non-drive-end shield, fan and dust cover. The slip rings, brush holder as well as brushes are visible through a perspex cover. The rotor is designed for use with the three-phase stator 747720.

Technical data:

- Class: 0.3
- Colour: light grey

747 725	Reluctance rotor
---------	------------------



DC shunt stator

Stator for a DC shunt current machine in the form of a working model demonstrating function, featuring drive-end shield and industrial terminal boxes mounted on a base. The stator is designed to accommodate different rotors and equipped with star-grip bolts to attach them.

Technical data:

- Class: 0.3
- Colour: Machine body, light grey
Base, black

747 726	DC shunt stator
---------	-----------------

Similar to illustration



DC rotor

Rotor for DC machine in the form of a working model demonstrating function, with non-drive-end shield, fan and dust cover. The collector, brush holder as well as the brushes are visible through a perspex cover. The rotor is designed for use with the DC stator (747 726).

Technical data:

- Class: 0.3
- Colour: light grey

747 728	DC rotor
---------	----------

Similar to illustration



Efficiency rotor

Rotor for a three-phase asynchronous machine with copper cage in the form of a working model demonstrating function, with non-drive-end shield. The rotor is designed for use with the three-phase stator 747720.

Technical data:

- Class: 0.3
- Cage material: copper
- Colour: light grey

747 729	Efficiency rotor
---------	------------------



System: Electrical machines training system



Supplementary set for electrical machines training system (62-005-230) for recording characteristics of electrical machines in all four operating quadrants.

Technical data:

- Machine test system
- CBM10 software MOMO / FCCP
- 3-phase transformer
- 3-pole on-off switch
- EMT adapter kit (adapter base for machine test system)
- Coupling
- Set of safety experiment leads

762 101	System: Electrical machines training system
---------	---

MPS set: Electrical machines training system



Electrical machines training system (62-005-230) with machine test system for recording characteristics of electrical machines in all four operating quadrants, consisting of:

- Electrical machines training system
- EMT storage frame
- EMT system frame
- Machine test system
- Software CBM10 MOMO / FCCP
- 3-phase transformer
- 3-pole on-off switch
- EMT adapter kit (adapter base for machine test system)
- Coupling
- Set of safety experiment leads

762 102*	MPS set: Electrical machines training system
----------	--

*The MPS set *Electrical machines training system* (762 102) is not available in all countries. Please contact your local dealer.

Literature

Cat.-No.	Designation
775 685 EN	LIT: T8.2.1.6 Drive Control
565 642	LIT: Three-phase transformers and three-phase transformer circuits, T 2.4.1
565 652	LIT: Three-phase rectifier circuits, T 2.4.2
588 34EN	LIT: PS3.4 STM Electricity – Basic electric circuits
588 35EN	LIT: PS3.5 STM Electricity – Electromagnetism
588 36EN	LIT: PS3.6 STM Electricity – Motors
775 115EN	LIT: E2.1.3.3 Electrical Machines Teaching Models
775 175EN	LIT: E2.4.1.1 STE Power Electronics
775 185EN	LIT: E2.2.1.0 Transformers 0.3
775 190EN	LIT: E2.2.2.0 DC Machines 0.3
775 195EN	LIT: E2.2.3.0 AC Machines 0.3
775 200EN	LIT: E2.2.4.0 Induction Machines 0.3
775 205EN	LIT: E2.2.5.0 Synchronous Machines 0.3
775 220EN	LIT: E2.3.1.0 Transformers 1.0
775 225EN	LIT: E2.3.2.0 DC Machines 1.0
775 230EN	LIT: E2.3.3.0 AC Machines 1.0
775 235EN	LIT: E2.3.4.0 Induction Machines 1.0
775 240EN	LIT: E2.3.5.0 Synchronous Machines 1.0
775 250EN	LIT: E2.4.2.1 Static Converter Valves
775 255EN	LIT: E2.4.2.2 Fault Simulator Dimmer
775 260EN	LIT: E2.4.3.1 Switchable Valves and DC Choppers
775 265EN	LIT: E2.4.3.2 Switched-Mode Power Supplies
775 270EN	LIT: E2.4.3.3 Inverters
775 280EN	LIT: E2.5.2.1 Static Converter Drive with DC Machines
775 285EN	LIT: E2.5.3.1 Drives with Induction Machines
775 286EN	LIT: E2.5.3.2 Basics of Frequency Converters
775 290EN	LIT: E2.5.3.4 Drives with Industry Frequency Converter 0.3
775 295EN	LIT: E2.5.3.5 Drives with Industry Frequency Converter 1.0
775 300EN	LIT: E2.5.3.3 Drives with Educational Frequency Converter
775 305EN	LIT: E2.6.2.1 AC Servo with Block Commutation
775 310EN	LIT: E2.6.2.2 AC Servo with Sine Commutation
775 315EN	LIT: E2.5.2.3 Position Servo Control
775 320EN	LIT: E2.6.1.1. Basics of Servo Technology
775 325EN	LIT: E2.6.1.2 DC Servo
775 330EN	LIT: E2.6.1.3 AC Servo
775 345EN	LIT: E2.6.1.4 Stepper Motor
775 350EN	LIT: E2.2.6.1 Motor with Frequency Converter 0.3
775 355EN	LIT: E2.3.6.1 Motor with Frequency Converter 1.0

The literature is also available in other languages.





INDEX

IN ALPHABETICAL ORDER

On the following pages you will find the index for our equipment sets and individual components.

- 1-3**
 3-Phase 26, 30, 33, 36-38, 42, 45-46, 61-65, 146
 3-Phase induction machines 36-37, 45
 3-Phase rectification 26
 3-Phase stator 30, 146
 3-Phase synchronous machines 38, 46
 3-Phase transformer 26, 33, 42
- A**
 AC Machines 35
 AC Machines 35, 44
 AC Servo 40, 69, 71-73, 115, 133
 AC Transformer 33, 42, 130
 AC/DC Power Supply 26-27, 49, 77, 100
 Actuator 57, 133
 Adapter, USB port/serial port 63, 71-73, 78
 Advanced Science Kit - Set BEL 26-27, 89-90
 Allen key 29, 85
 Amplifier 33, 42, 52-55, 60-63, 67-68, 71-72, 132, 138
 Auxiliary phase motor 116-117, 125
- B**
 Basic machine unit 29, 105
 Basic set 26, 49, 104-105
 Basic terminal unit 29, 106
 Batteries 26-27, 90
 Belt 29
 Blocking gear 36, 45, 113
 Brake 37
 Brass resistance wire 84
 Bridging plugs 26, 49, 76
 Brush 29, 85
 Brushless DC machine 40
 Bulb 26-27, 29, 52, 77
- C**
 Cable 26, 52-55, 60-63, 71-73, 76, 91, 109
 Candles 26-27, 75
 Capacitive load 29, 33, 36-38, 42, 45-46, 121, 129
 Capacitor 26-27, 29, 35, 44, 53-55, 60, 88, 116-118, 126, 135
 Capacitor motor 35, 44, 88, 116-118, 126
 CBC 12.5 Servo technology 71-73, 108
 CBM10 MOMO/FCCP 30, 34-40, 43-47, 61, 63-65, 71-72, 108
 CD: COM3LAB software 28, 50, 57, 91
 Chrome-nickel resistance wire 26-27, 84
 COM3LAB 28, 50, 57, 91-96, 134
 Commutation pick-up 40, 71-73, 111, 139, 140
 Connecting lead 26-27, 29, 43-46, 49, 58, 71-72, 76
 Constantan resistance wire 26-27, 84
 Control unit block commutation 139
 Control unit PWM/PFM 53-55, 60-61, 63, 139, 144
 Control unit sine commutation 140
 Control unit six pulse, digital 61, 137
 Converter controller unit 51, 136
 Converter input/output 62, 63, 71-73, 140
 Converters 51-55, 62
 Copper resistance wire 84
 Coupling 30, 34-40, 43-47, 57, 59, 61, 63-65, 71-73, 109, 122-123
 Coupling guard 30, 34-40, 43-47, 57, 59, 61, 63-65, 71-73, 109, 123
- D**
 Dahlander 36, 45, 113
 DC Compound machine 34, 43, 51, 59-60, 113
 DC Machine supply 30, 34, 43, 46, 38, 98
 DC Machines 34, 43
 DC Multi-function machine 43, 123
 DC Rotor 30, 147
 DC Servo 67-68, 132
 DC Shunt stator 30, 147
 DC-Chopper drive with DC machines 60
 Digital hand-held tachometer 75
 Digital multimeter 49, 81
 Digital storage oscilloscope 52-55, 59-63, 71-72, 87
 Diode 53-54, 60, 135
 Double wound machine 114
 Drive unit 29, 107
 Drives 57, 59-65, 149
 Driving belt 29
- E**
 Educational frequency converter 63, 149
 Efficiency 29-30, 147
 Efficiency rotor 30, 147
 ELM 29, 84-87, 106
 Excitation voltage controller 145
 Extra-low voltage supply 29, 38, 96
- F**
 Fault simulator for phase control 52, 145

Field regulator.....	29, 34, 43, 107, 114, 124
Flywheel.....	34, 43-44, 121, 129
Frequency converter motor.....	39
Function generator.....	27, 49, 55, 59-60, 70, 78, 100
Fuse threefold super-fast.....	53-55, 60, 61, 137
G	
Gear.....	36, 45, 113
H	
Hand-held tachometer.....	29, 75
I	
IGBT.....	53-55, 60-61, 145
Incremental tacho.....	71, 73, 110
Induction machines.....	36, 45
Inductive load.....	33, 38, 42, 46, 121
Industrial frequency converter.....	64-65, 141-142
Industrial servos.....	71-73
Insulation tester.....	36, 45, 83
Interference suppressor filter.....	111, 125
Inverters.....	55, 149
Iron resistance wire.....	26-27, 84
Isolation amplifier.....	33, 42, 52-55, 60-63, 71-72, 138
L	
Lamp.....	29, 52, 89, 108
Leylab.control.....	55, 58-61, 63, 67-68, 70, 73
Limiters.....	61, 138
Linear motor basic unit.....	29, 107
Linear motor with coil assembly.....	29, 107
Linear unit.....	73, 109-110
Load power electronics.....	51, 53-55, 61-62, 135
M	
Machine assembly kits.....	29-31
Machine test system.....	30, 34-40, 43-47, 61, 63-65, 71-72, 115, 124
Machines.....	28-31, 34-38, 43-46, 57-58, 60-61, 94, 132, 148-149
Machines with rotor kits.....	30
Magnets.....	29, 77, 84, 86, 106
Manual synchronisation unit.....	38, 46, 145
Masks.....	29, 106
Master unit.....	28, 50, 57, 91
Mechatronic motors.....	39-40, 47
MOMO/FCCP.....	30, 34-40, 43-47, 61, 63-65, 71-72, 108
MOSFET.....	53, 144
Motor protection switch.....	35-38, 44-46, 119
Motor with FCC.....	39, 47, 122
Moving iron meter.....	38, 46, 102
MPS set: Electrical machines training system.....	31
Multi-function machine.....	36, 38, 43, 61, 119, 123, 127
Multi-functional meter.....	102
Multimeter.....	26, 29-30, 33-40, 42-46, 49, 51-55, 59-65, 71-73, 82
N	
Net.....	55, 58-61, 63, 67-68, 70, 73, 100, 131
O	
Oil.....	29, 87
Oscilloscope.....	26, 33, 42, 49, 52-55, 59-63, 71-72, 87
P	
Panel frame.....	29-30, 33-40, 42-47, 49-55, 57-59, 61-65, 67-73, 98
Phase commutated converter.....	134
Phase control noise filter.....	51-55, 59-61, 137
Pick-up.....	29, 40, 71, 73, 106, 111
PID digital controller.....	58, 61, 63, 67-68, 73, 131
Plug-in board.....	49, 98
Plug-in power supply.....	26, 49, 59, 84
Pole reverser SW.....	36-37, 45, 113
Pole reverser, Dahlander.....	36, 45, 113
Position controller.....	73, 141
Position servo control.....	73
Potentiometric angle transducer.....	73, 110
Power amplifier.....	67-68, 132
Power circuit breaker module.....	30, 34-38, 43-46, 146
Power factor meter.....	33, 35-38, 42, 44-46, 102
Power meter.....	61, 101
Probe.....	26, 33, 42, 49, 52-55, 59-63, 71-72, 87
Profi-CASSY.....	58, 67-70, 80
R	
Rectifier.....	26, 53-55, 60-61, 135, 149
Reference variable generator.....	53-55, 58, 60-61, 63, 71-73, 130
Reluctance motor.....	30, 121, 147
Repulsion motor.....	116, 125
Resistive load.....	33-34, 36-38, 42-43, 45-46, 121, 129
Resolver.....	72-73, 111
Reversing switch.....	36-38, 45, 112
Rheostat.....	40, 53, 83

- Rotor position pick-up.....29, 106
 Rotor starter36, 45, 61, 120, 128
 Run-up control unit61, 137
- S**
- Safety bridging plugs.....29, 30, 33-40, 42-47, 58, 64-65, 76
 Safety connecting lead.....70, 73, 76
 Salient pole rotor30, 38, 46, 146
 Scissors.....26-27, 90
 Scott transformer.....33, 42, 130
 Sensor-CASSY 2.....26, 51, 79
 Sensor-CASSY 2 Starter26, 29, 51, 79
 Series wound machine.....114, 123
 Servo.....40, 67-73, 108, 115, 131-133, 149, 150
 Servo setpoint generator67-69, 131
 Set of machines.....58, 132
 Setpoint67-69, 131
 Shaft end guard.....30, 34-36, 38, 40, 43-46, 50-51,
 53, 57, 59-61, 63-65, 71-73, 109,123
 Shunt wound machine53, 57, 113, 123
 Single-phase supply unit44, 50, 62-63, 71-73, 99
 Single-phase transformer.....33, 42, 130
 Slip-ring motor36, 45, 120, 128
 Slip-ring rotor30, 146
 Smooth core rotor.....30, 38, 46, 147
 Soft starter.....36-37, 45, 112
 Software: Leylab.control Lite.....55, 58-61, 63, 67-68, 70, 73
 Squirrel cage fault simulator.....36, 45, 111
 Squirrel cage motor.....30, 36-37, 45, 50, 63-65,
 117-119, 126-127
 Squirrel cage rotor.....30, 146
 Stabilised power supply53-55, 57-58, 60-61, 63, 67-71, 99
 Star-delta reversing switch.....36-37, 45, 112
 Star-delta starter36-37, 45, 112
 Star-delta switch36-37, 45, 112
 Starter26, 29, 34, 36-37, 43, 45, 51, 58, 61,
 67-70, 79-80, 106, 112, 114, 120, 124, 128
 STE.....26-27, 29, 49, 67-69, 76, 88-89, 104, 105, 149
 Stepper motor70, 108, 150
 Supplies.....54, 149
 Switched-mode power supplies.....54
 Synchronous machine.....38, 46, 120, 128
- T**
- Tacho generator.....57, 59, 61, 63, 68, 71, 73, 75, 110, 133
 Three-phase generator in case.....29, 97
- Three-phase supply / experiment transformer29, 97
 Three-phase voltage supply28, 33, 42, 88, 96-97
 Thyristor.....53, 59, 61, 135, 143-144
 Toroidal transformer33, 42, 130
 Transformer.....26, 29, 33, 35, 42, 44, 51-55,
 59-61, 97, 99, 129-130, 136, 149
 Trigger point limiter61, 138
 Two-channel oscilloscope.....26, 33, 42, 49, 87
- U**
- Ultra-rapid53-55, 60, 61
 Universal converter.....40, 50, 62-63, 71-73, 141
 Universal motor34-35, 43-44, 116, 125
- V**
- Valves.....51, 53, 149
- W**
- WinFACT58, 134

TECHNICAL SERVICE AND CONSULTING

LEYBOLD DOES NOT ONLY PROVIDE THE HIGHEST POSSIBLE PRODUCT QUALITY, BUT ALSO INDIVIDUAL ADVICE AND TECHNICAL AFTER-SALES SERVICE.

INDIVIDUAL ADVICE AND STOCK-TAKING

Are you planning to re-equip your laboratory or simply to add to its equipment? Our specialised advisor will be happy to give you support by suggesting a tailor-made combination suitable to your type of school.

GOODS SERVICE, INSTALLATION COMMISSIONING AND ON-SITE BRIEFING

We would be delighted to check your new equipment on site for completeness and functionality. We can either take on the whole task of installation for you or our specialists can commission the devices and systems that you have already installed on site yourselves. We would, of course, be delighted to conduct one or more tests together with you and to explain in detail the functions of each individual device.

LEYBOLD®

TECHNICAL AFTER-SALES SERVICE

You may have a technical question on one of our devices or pieces of equipment. Our service team is available by telephone at +49 2233 604-430 and by e-mail at service@ld-didactic.de.

SPARE PARTS SERVICE

You can naturally order replacement parts for your equipment.

REPAIR SERVICE

If, despite our demanding quality standards, you should find a fault in your LEYBOLD product, we will naturally repair it as soon as possible. If you still cannot make the equipment work as intended after calling our technical service, you can find help quickly and easily through our „on-site service“. Our service technicians come to you, to find the appropriate technical solution on site. Alternatively, you can of course also send your device for repair by post.

REPAIR GUARANTEE FOR A MINIMUM OF 10 YEARS

Our products stand for high quality and durability. If your device should become faulty even many years after purchase, generally we will still be able to repair it. We guarantee the repair of all our devices for 10 years from the date of purchase – and for much of our products, for much longer.



INDIVIDUAL
ADVICE
ON-SITE

TECHNICAL
SERVICE
AFTER-SALES

BRIEFING
ON-SITE

PHYSICS

CHEMISTRY
BIOLOGY

ENGINEERING



1305222 12.2013 LD
Subject to technical amendments.

CONTACT

GERMANY:

LD DIDACTIC GmbH
Leyboldstr. 1
D-50354 Hürth
Tel.: +49 2233 604 0
Fax: +49 2233 604 222
Email: info@ld-didactic.de
www.ld-didactic.com

UK:

Feedback Instruments Limited
5 & 6 Warren Court
Park Road, Crowborough
East Sussex
TN6 2QX
Tel.: +44 (0)1892 653322
Fax: +44 (0)1892 663719
Email: sales@feedback-instruments.com
www.feedback-instruments.com

USA:

Feedback Incorporated
437 Dimmocks Mill Road
Suite 27
Hillsborough
NC 27278
Tel.: +1 (919) 644 6466
Fax: +1 (919) 644 6470
Email: sales@feedback-instruments.com
www.feedback-instruments.com

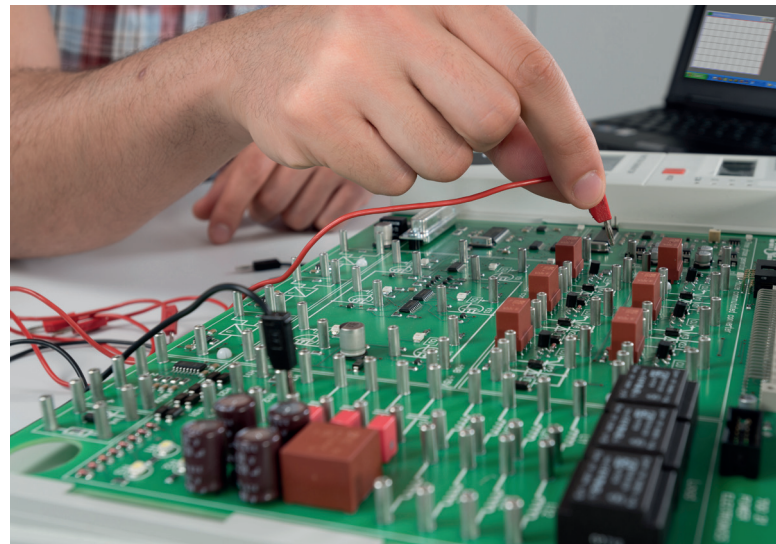
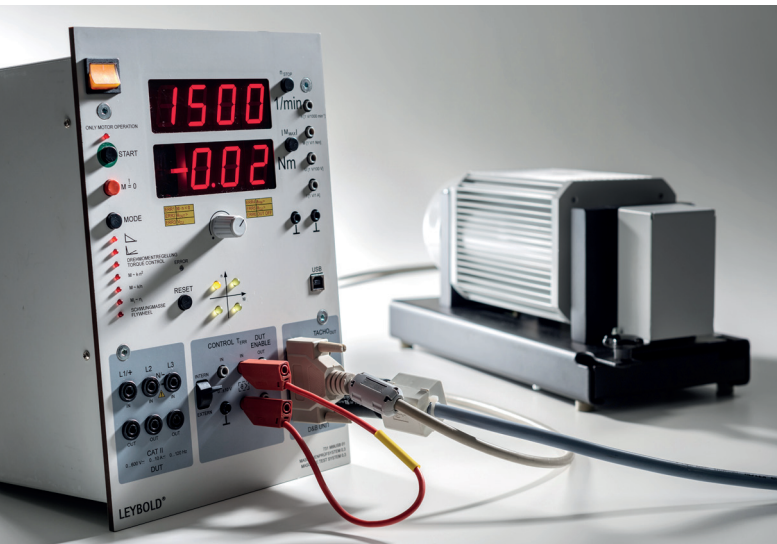

WWW.LD-DIDACTIC.COM

BRANDS OF THE LD DIDACTIC GROUP

LEYBOLD® Feedback ELWE® TECHNIK